



深圳市奥伦德科技股份有限公司  
Shenzhen Orient Technology Co., Ltd

---

# 产品规格书

## Specification Sheet

品 名(P/N): 光电耦合器 Photocoupler

客户名称(Customer): \_\_\_\_\_

本厂型号(Mfg P/N): ORPC-815

日 期(Date): \_\_\_\_\_



● **特点(Features):**

1. 电流转换比(CTR: 600%—7500%工作条件  $I_F=1\text{mA}$ ,  $V_{CE}=2\text{V}$ )  
Current conversion ratio (CTR:600%—7500% working condition  $I_F=1\text{mA}$ ,  $V_{CE}=2\text{V}$ )
2. 绝缘电压: ( $V_{ISO}=5,000\text{Vrms}$ ) Insulation Voltage = 5,000Vrms,
3. 响应时间 (tr: TYP. 60 $\mu\text{s}$ ; tf: TYP. 53 $\mu\text{s}$ )工作条件  $V_{CE}=2\text{V}$ ,  $I_C=10\text{mA}$ ,  $R_L=100\ \Omega$   
Response Time (tr: TYP.60 $\mu\text{s}$ ; tf: TYP. 53 $\mu\text{s}$ )working condition  $V_{CE}=10\text{V}$ ,  $I_C=10\text{mA}$ ,  $R_L=100\ \Omega$



● **说明 (Instructions)**

1. ORPC-815 系列光耦都由一个红外发光二极管和达林顿光探测器组成。  
The ORPC-815 series of devices each consist of an infrared emitting diodes, optically to a photo Darlington detector.
2. ORPC-815 的引脚中心距是 2.54mm Pin pitch of ORPC-815 is 2.54mm



● **应用范围 (Application Range)**

1. 电话机、电话交换机. Telephone set, telephone exchangers
2. 序列控制器. Sequence controllers
3. 系统设备, 测量仪器. System appliances, measuring instruments
4. 信号在不同电势和阻抗电路之间传输. Signal transmission between circuits of different potencies

● **最大绝对额定值 (常温=25℃) Max Absolute rated Value (Normal Temperature=25℃)**

参数 Parameter		符号 Symbol	额定值 Rated Value	单位 Unit
输入 Input	正向电流 Forward Current	$I_F$	50	mA
	反向电压 Reverse Voltage	$V_R$	6	V
	功耗率 Power Dissipation	P	70	mW
	峰值正向电流 Peak forward Current (1 $\mu\text{s}$ , pulse)	$I_{FP}$	1	A
输出 Output	集极与射极电压 Collector and emitter Voltage	$V_{CEO}$	35	V
	射极与集极电压 Emitter and collector Voltage	$V_{ECO}$	6	V
	集极电流 Collector Current	$I_C$	80	mA
	消耗功率 Consume Power	$P_C$	150	mW
	总功率消耗 Total Power Dissipation	$P_{tot}$	200	mW
*1 绝缘电压 Insulation Voltage		$V_{iso}$	5,000	Vrms
工作温度 Working Temperature		$T_{OPR}$	-55 ~ + 125	℃
存贮温度 Deposit Temperature		$T_{STG}$	-55 ~ + 125	
*2 焊锡温度 Soldering Temperature		$T_{sol}$	260	

- \*1. 交流测试, 时间 1 分钟, 湿度 = 40~60% AC Test, 1 minute, humidity = 40~60%  
 以下是绝缘测试的方法. Insulation test method as below:
  - (1) 将产品的两端短路。 Short circuit both terminals of photocoupler
  - (2) 测试绝缘电压时无电流通过。 No Current when testing insulation voltage
  - (3) 测试时加正弦波形电压。 Adding sine wave voltage when testing
- \*2. 锡焊时间为 10 秒 soldering time is 10 seconds



● 光电特性(常温=25℃) Opto-electronic Characteristics

参数 Parameter		符号 Symbol	条件 Condition	最小 Min	中.Mid ium	最大 Max	单位 Unit
输入 Input	正向电压 Forward Current	$V_F$	$I_F=20mA$	---	1.2	1.4	V
	反向电压 Reverse Voltage	$I_R$	$V_R=4V$	---	---	10	$\mu A$
	终端电容 Terminal Capacitance	$C_t$	$V=0, f=1KHz$	---	30	250	pF
输出 Output	集极至射极电流 Collector to emitter Current	$I_{CEO}$	$V_{CE}=10V,$ $I_F=0mA$	---	---	1	$\mu A$
	集极与射极衰减电压 Collector and Emitter attenuation Voltage	$BV_{CEO}$	$I_C=0.1mA$ $I_F=0mA$	35	---	---	V
	射极与集极衰减电压 Emitter and Collector attenuation Voltage	$BV_{ECO}$	$I_E=10\mu A$ $I_F=0mA$	6	---	---	V
传输特性 Transforming Characteristics	*1 电流转换比 Current conversion ratio	CTR	$I_F=1mA$	600	---	7500	%
	集极电流 Collector Current	$I_C$	$V_{CE}=2V$	6	---	75	mA
	集极与射极饱和电压 Collector and Emitter Saturation Voltage	$V_{CE(sat)}$	$I_F=20mA$ $I_C=5mA$	---	0.8	1	V
	绝缘阻抗 Insulation Impedance	$R_{iso}$	DC500V 40~60%R.H.	$5 \times 10^{10}$	$1 \times 10^{11}$	---	$\Omega$
	电容量 capacitance	$C_f$	$V=0, f=1MHz$	---	0.6	1.0	pF
	转换频率 Transforming Frequency	$f_c$	$V_{CE}=5V,$ $I_C=2mA$ $R_L=100\Omega, -3dB$	1	6	---	kHz
	上升时间 Risetime	$t_r$	$V_{CE}=2V,$ $I_C=10mA$	---	60	300	$\mu s$
	下降时间 Descend Time	$t_f$	$R_L=100\Omega$	---	53	250	$\mu s$

- 电流转换比 Current Conversion Ratio =  $I_C / I_F \times 100\%$

● 命名规则

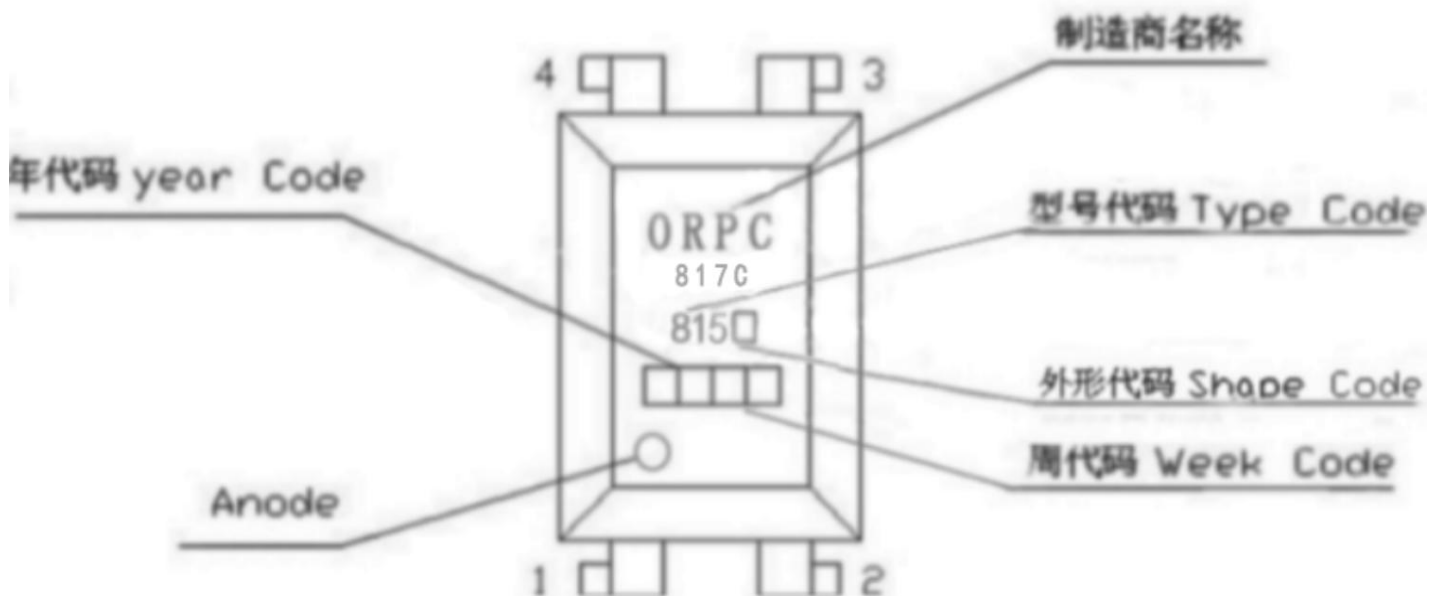

1、制造商名称：ORPC 代表制造商 Shenzhen Orient Components Co., Ltd.

2、型号代码 Type Code：815 代表产品型号

3、外形代码 Shape Code：

空白--代表ORPC-815；

M--代表ORPC-815M；

S--代表ORPC-815S。

4、年代码 year Code：   例如：F7 或C7，其中F表铁支架/C表铜支架，7代表2017年、依此类推。。

5、周代码 Week Code：   01代表第一周、02代表第二周、依此类推

6、Anode： 阳极



● 外形尺寸 Outer Dimension

1. ORPC-815

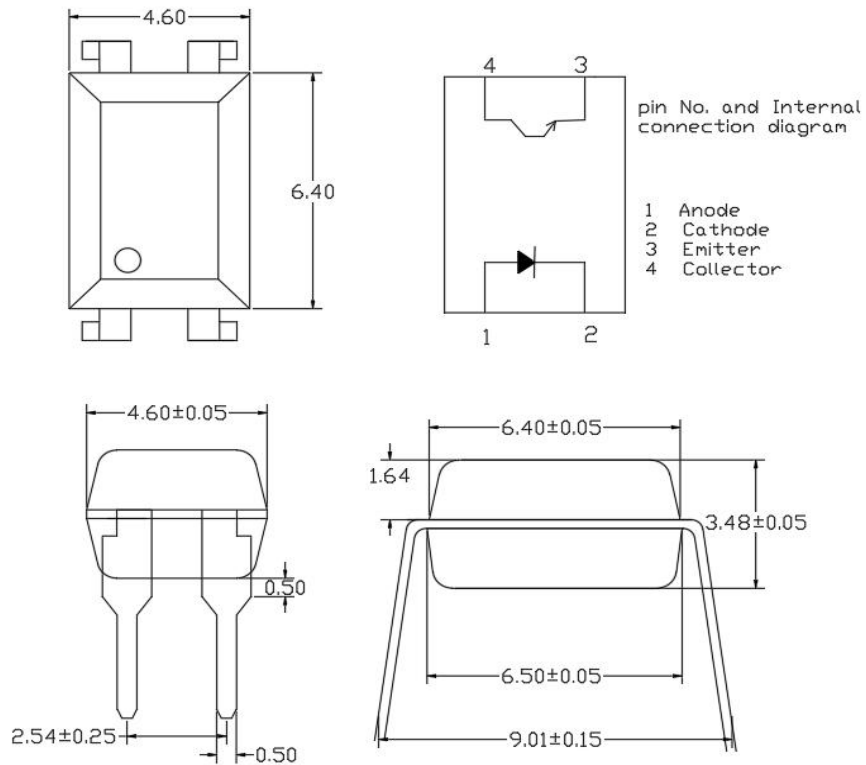

2. ORPC-815M

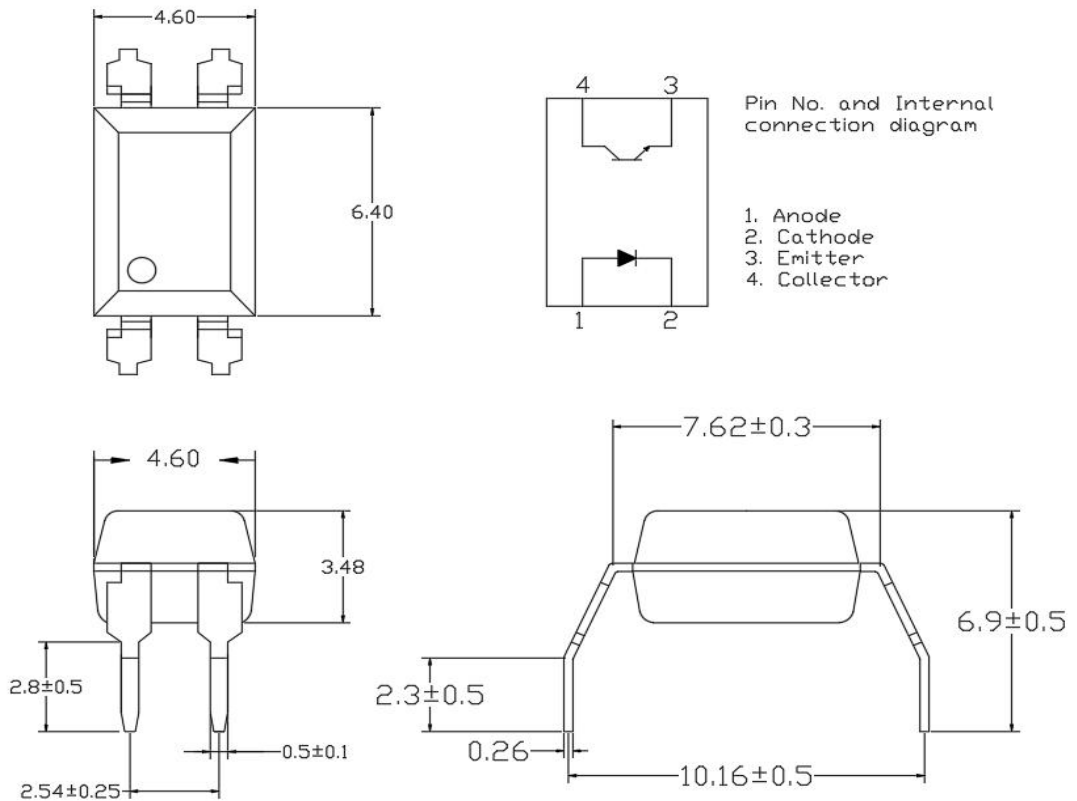

### 3.ORPC-815S

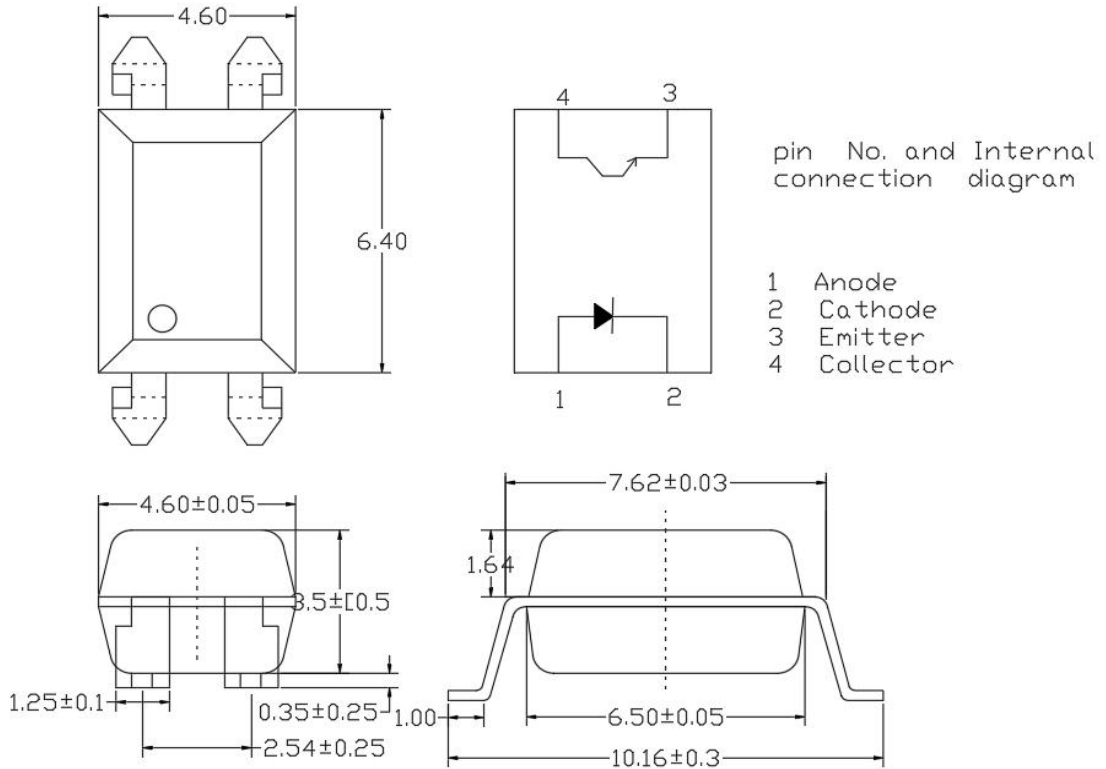

### ● 编带尺寸 (Taping Dimensions)

#### 1. OR-815S-TA

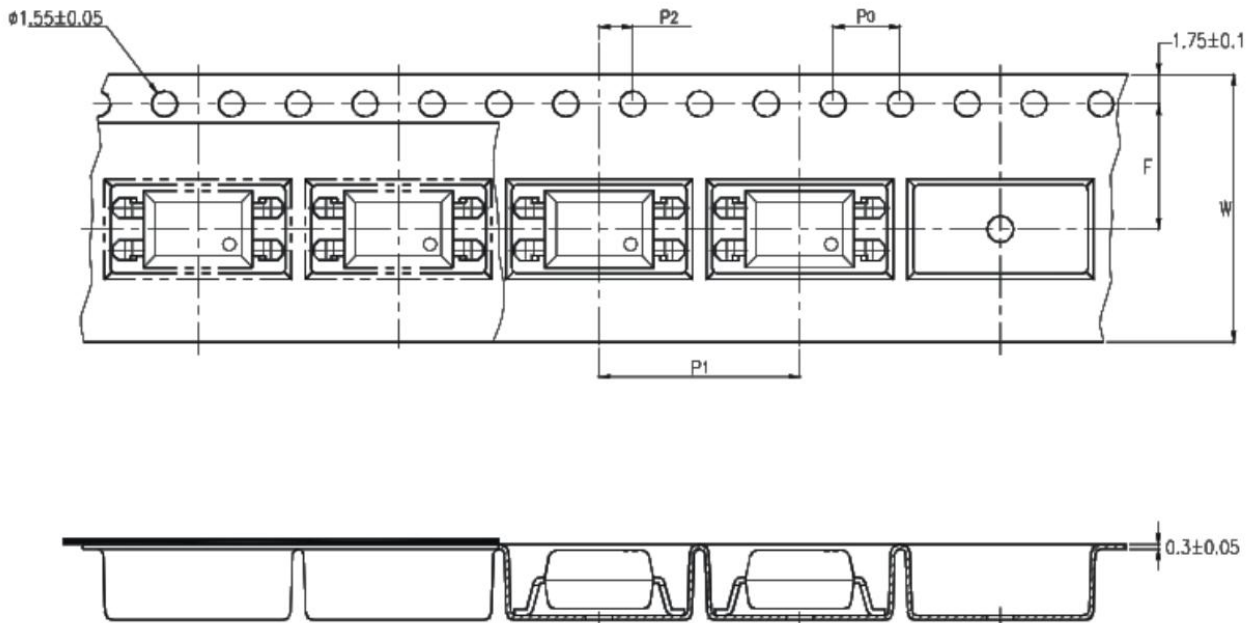

2. OR-815S-TA1

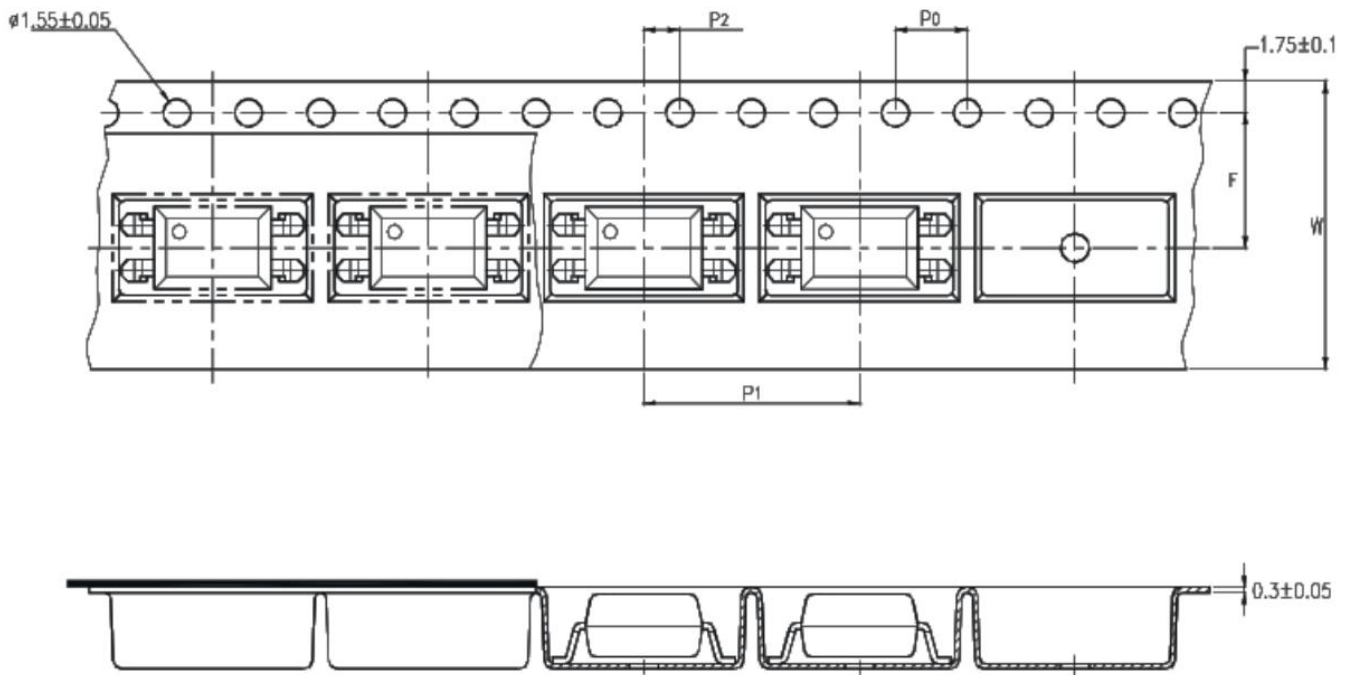

类型	符号	尺寸:毫米(英寸)
带宽	W	$16 \pm 0.3$ (.63)
孔距	$P_0$	$4 \pm 0.1$ (.15)
孔距	F	$7.5 \pm 0.1$ (.295)
	$P_2$	$2 \pm 0.1$ (.0079)
间隔	$P_1$	$12 \pm 0.1$ (.472)

封装类型	TA/TA1
数量 (个)	1000



### 3. OR-817S-TP

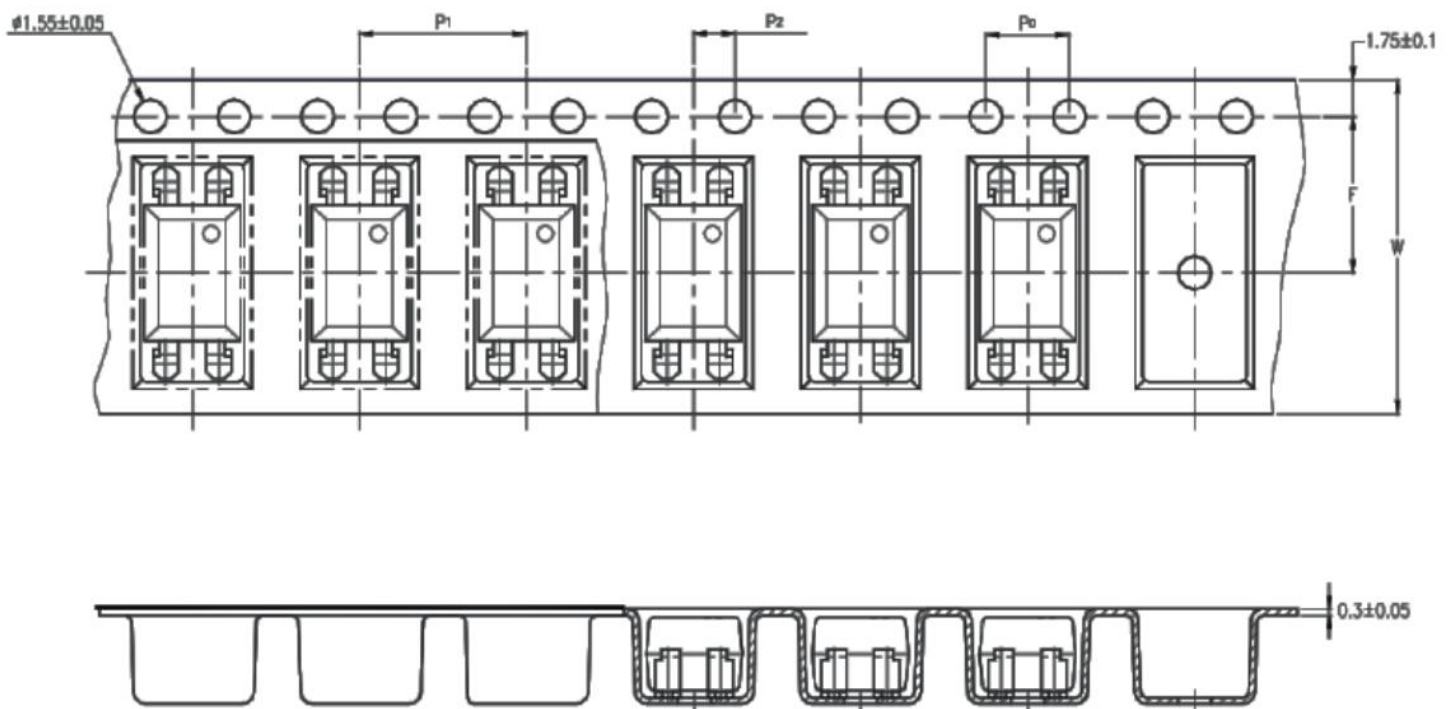

类型	符号	尺寸:毫米(英寸)
带宽	W	$16 \pm 0.3$ (.63)
孔距	P0	$4 \pm 0.1$ (.15)
孔距	F	$7.5 \pm 0.1$ (.295)
	P2	$2 \pm 0.1$ (.0079)
间隔	P1	$8 \pm 0.1$ (.472)

封装类型	TP
数量(个)	2000





● 焊接温度曲线图 (Temperature Profile Of Soldering)

1. 红外回流焊 (jedec-std-020c 兼容) (IR Reflow soldering (JEDEC-STD-020C compliant))

注意：一次焊接回流建议在时间和温度配置文件如下所示的条件下。不要焊接超过三次。

配置项	条件
预热 (Preheat)	
-最低温度 (T <sub>Smin</sub> )	150°C
-最高温度 (T <sub>Smax</sub> )	200°C
-时间 (最小到最大 (T <sub>S</sub> ))	90±30 sec
焊接区 (Soldering zone)	
-温度 (T <sub>L</sub> )	217°C
-时间 (t <sub>L</sub> )	60 sec
峰值温度 (Peak Temperature)	260°C
爬升率 (Ramp-up rate)	3°C / sec max.
下降率 (3°C / sec max.)	3~6°C / sec

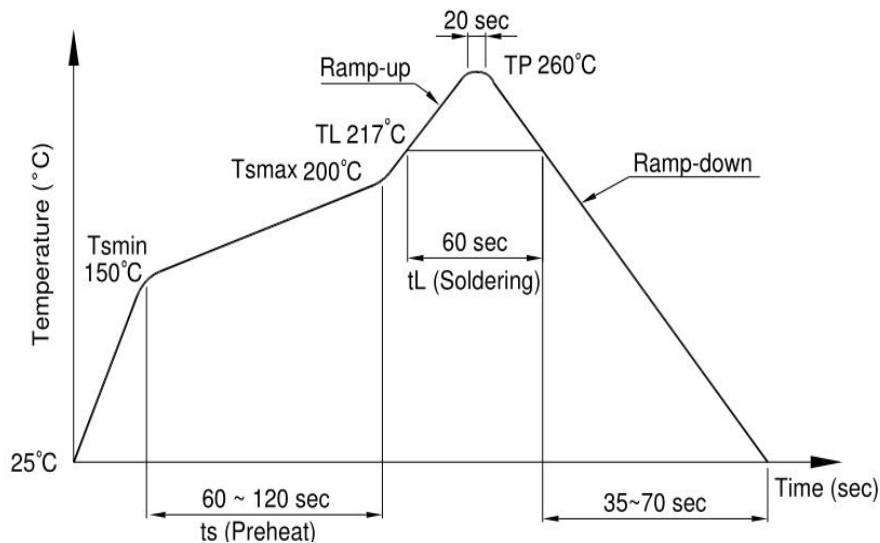



2. 超声波焊接 (jedec22a111 兼容) (Wave soldering (JEDEC22A111 compliant))

建议在温度条件下一致性焊接。

温度 (Temperature)	260+0/-5°C
时间 (Time)	10 sec
预热温度 (Preheat temperature)	25 to 140°C
预热时间 (Preheat time)	30 to 80 sec

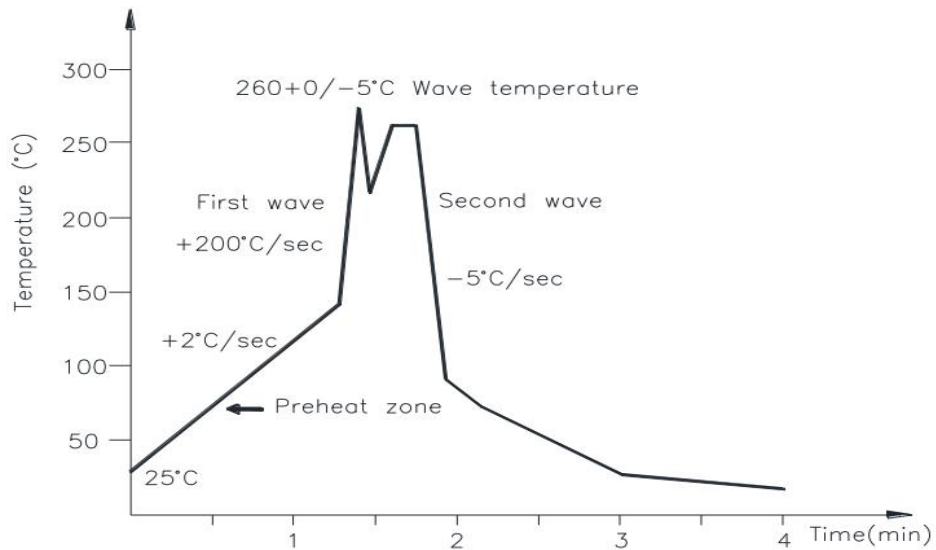

3. 电烙铁手工焊接 (Hand soldering by soldering iron)

允许单铅焊接在每一个过程中, 建议一致性焊接。

温度 (Temperature)	380+0/-5°C
时间 (Time)	3 sec max



● 特性曲线 Characteristics Curve

Fig.1 Forward Current vs. Ambient Temperature

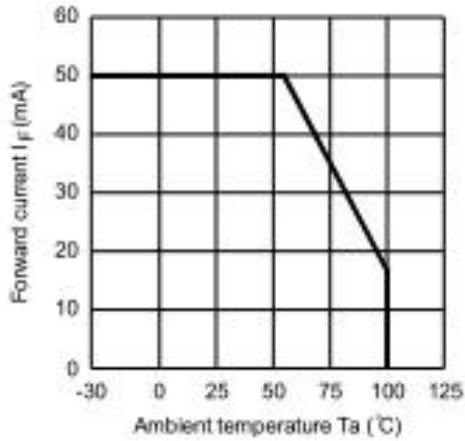

Fig.2 Collector Power Dissipation vs. Ambient Temperature

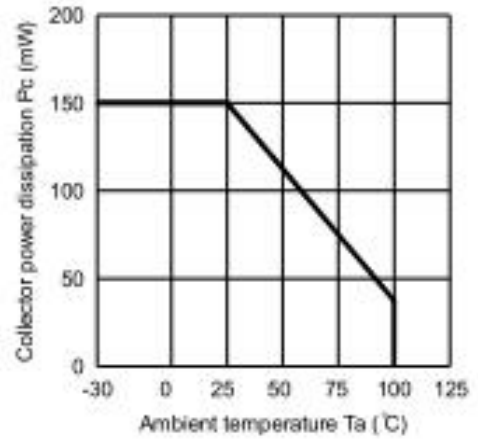

Fig.3 Collector-emitter Saturation Voltage vs. Forward Current

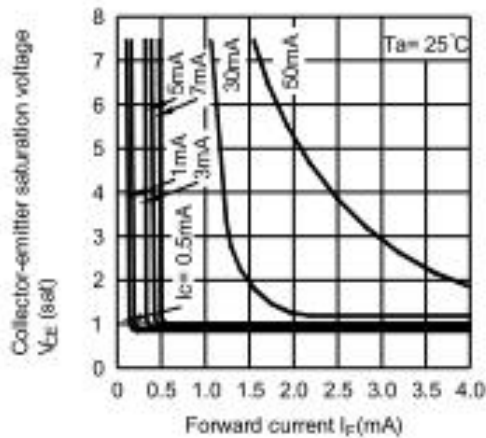

Fig.4 Forward Current vs. Forward Voltage

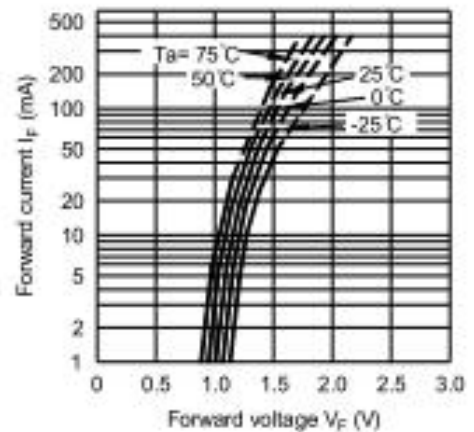

Fig.5 Current Transfer Ratio vs. Forward Current

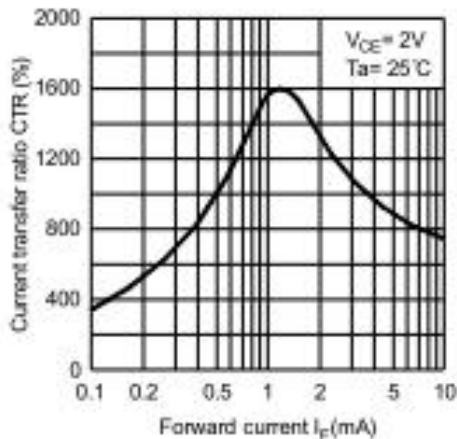

Fig.6 Collector Current vs. Collector-emitter Voltage

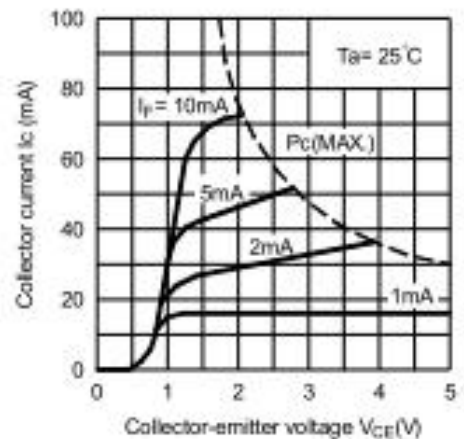

Fig.7 Relative Current Transfer Ratio vs. Ambient Temperature

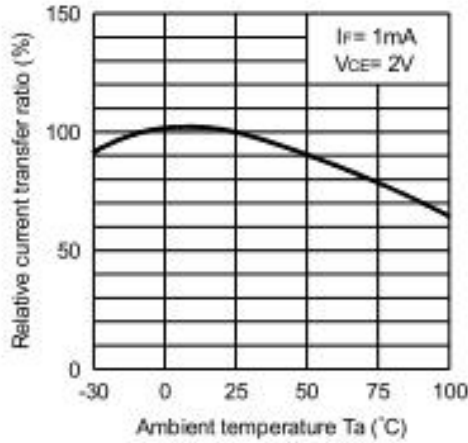

Fig.8 Collector-emitter Saturation Voltage vs. Ambient Temperature

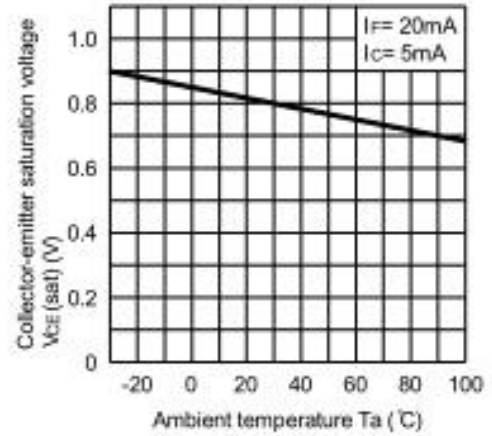

Fig.9 Collector Dark Current vs. Ambient Temperature

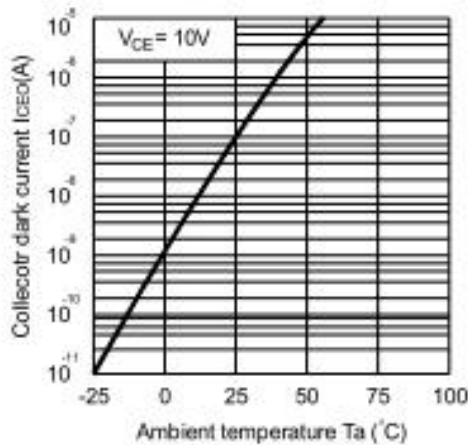

Fig.10 Response Time vs. Load Resistance

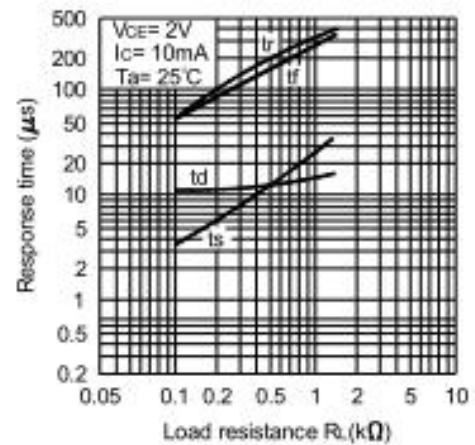
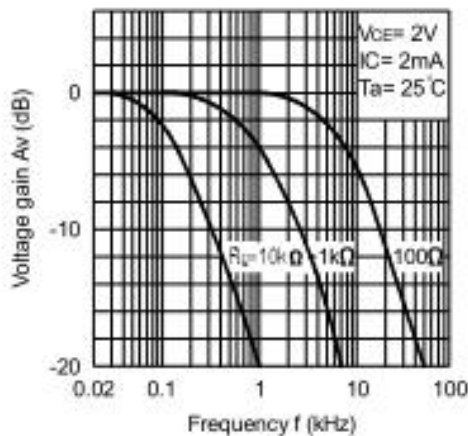
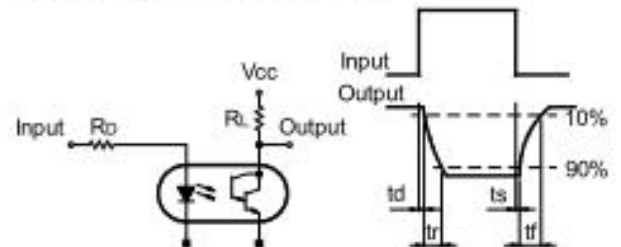

Fig.11 Frequency Response



Test Circuit for Response Time



Test Circuit for Frequency Response

