

**» Features**

- » Excellent clamping capability
- » Low leakage current
- » Low capacitance
- » High surge capability
- » Glass passivated chip
- » Epoxy resin package
- » Will not fatigue
- » RoHS Compliant

- Meets ISO7637-2、16750-2 surge specification
- ISO 7637-2 P5a:
  - 12V System ( 65-87V 0.5-4Ω 40-400ms)
  - 24V System (123-174V 1-8Ω 100-350ms)

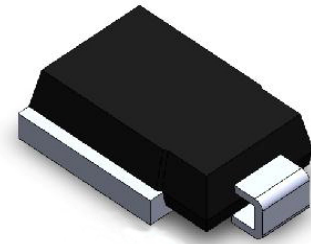

DO-218 (DO-218AB)

**»Mechanical Characteristics**

- Package: DO-218 plastic package.
- Lead Finish: Matte Tin
- Case Material: Epoxy Molding Compound.
- UL Flammability Classification Rating 94V-0
- Moisture Sensitivity: Level 1 per J-STD-020

**»Applications**

- Auto powers system
- Can-bus
- ABS powers
- Automotive instrument
- Car GPS

**»Electrical Parameters**

Parameter	Definition
$C_J$	Junction Capacitance - typical capacitance measured with 0V or $V_R$ bias
$I_{PP}$	Peak Pulse Current - maximum rated peak impulse current
$V_C$	Clamping Voltage - Peak voltage measured across the suppressor at a specified $I_{ppm}$ (peak impulse current)
$V_{BR}$	Breakdown Voltage - Maximum voltage that flows through the TVS at a specified test current ( $I_T$ )
$I_R$	Leakage Current - maximum peak off-state current measured at $V_R$
$V_R$	Peak Off-state Voltage - maximum voltage that can be applied while maintaining off state

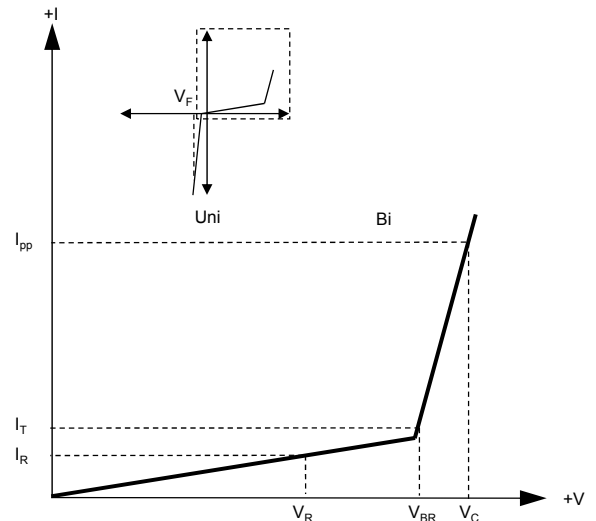
**»Summary of Packing Options**

Package	Packing Description	Packing Quantity	Industry Standard
DO-218	Tape/Reel, 13" reel	750	EIA-481-1
	Tape/Reel, 7" reel	150	EIA-481-1

**»Absolute Maximum Ratings ( $T_A=25^{\circ}\text{C}$  unless otherwise noted)**

Parameter	Symbol	Value	Units	Remarks
Peak Pulse Power Dissipation	$P_{PPM}$	6600	W	(Note1)
Peak Pulse Power Dissipation	$P_{PPM1}$	5200	W	(Note2)
Steady State Power Dissipation	$P_D$	8	W	(Note3)
Peak Forward Surge Current	$I_{FSM}$	700	A	(Note4)
Maximum Instantaneous Forward Voltage at 100A	$V_{FM}$	3.5	V	
Typical Thermal Resistance Junction to Case	$R_{\theta JC}$	0.9	$^{\circ}\text{C/W}$	
Typical Thermal Resistance Junction to Ambient	$R_{\theta JA}$	11	$^{\circ}\text{C/W}$	
Operating Temperature Range	$T_J$	-55 to 175	$^{\circ}\text{C}$	
Storage Temperature Range	$T_{STG}$	-55 to 175	$^{\circ}\text{C}$	

Notes1: Non-repetitive current pulse , 10/1000us Waveform.

Notes2: Non-repetitive current pulse , 10/10000us Waveform.

Notes3: Infinite Heat Sink at  $T_A=50^{\circ}\text{C}$ .

Notes4: Measured on 8.3ms single half sine wave or equivalent square wave, duty cycle=4 per minute maximum.

**»Electrical Characteristics ( $T_A=25^{\circ}\text{C}$  unless otherwise noted)**

Part Number	Reverse Stand-off Voltage $V_R$ (V)	Breakdown Voltage $V_{BR}$ @ $I_T$ (V)		Test Current $I_T$ (mA)	Maximum Clamping Voltage $V_C$ @ $I_{PP}$ (V)	Maximum Peak Pulse Current $I_{PP}$ (A)	Maximum Reverse Leakage $I_R$ @ $V_R$ ( $\mu\text{A}$ )
		Min	Max				
SM8S10A	10	11.1	12.3	5	17	388	15
SM8S11A	11	12.2	13.5	5	18.2	363	10
SM8S12A	12	13.3	14.7	5	19.9	332	10
SM8S13A	13	14.4	15.9	5	21.5	307	10
SM8S14A	14	15.6	17.2	5	23.2	284	10
SM8S15A	15	16.7	18.5	5	24.4	270	10
SM8S16A	16	17.8	19.7	5	26	254	10
SM8S17A	17	18.9	20.9	5	27.6	239	10
SM8S18A	18	20	22.1	5	29.2	226	10
SM8S20A	20	22.2	24.5	5	32.4	204	10
SM8S22A	22	24.4	26.9	5	35.5	186	10
SM8S24A	24	26.7	29.5	5	38.9	170	10
SM8S26A	26	28.9	31.9	5	42.1	157	10
SM8S28A	28	31.1	34.4	5	45.4	145	10
SM8S30A	30	33.3	36.8	5	48.4	136	10
SM8S33A	33	36.7	40.6	5	53.3	124	10
SM8S36A	36	40	44.2	5	58.1	114	10
SM8S40A	40	44.4	49.1	5	64.5	102	10
SM8S43A	43	47.8	52.8	5	69.4	95.1	10

»Rating And Characteristic Curves ( $T_A=25^\circ\text{C}$  unless otherwise noted)

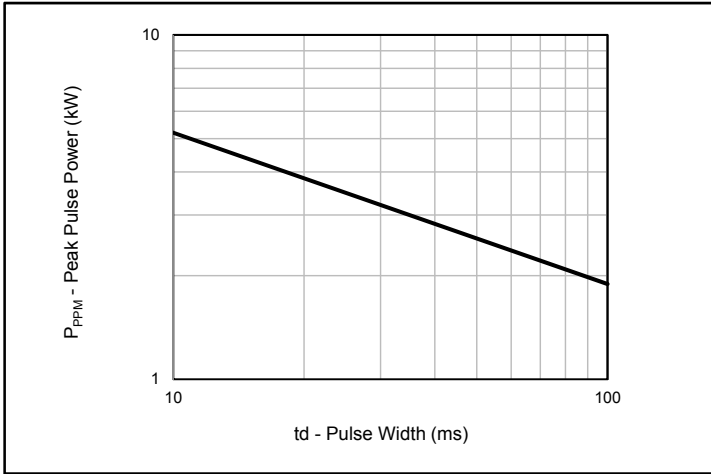

Fig.1 - Peak Pulse Power Rating

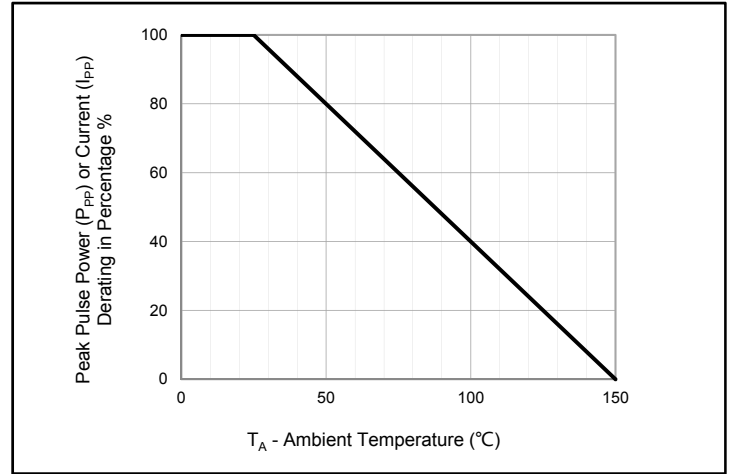

Fig.2 - Pulse Derating Curve

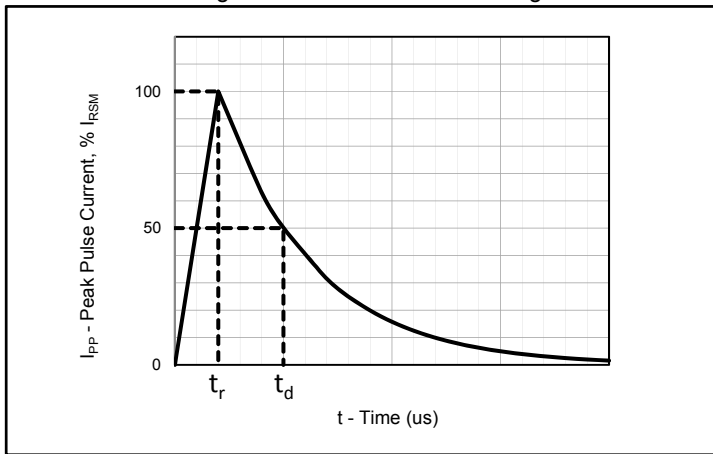

Fig.3 - Pulse Waveform

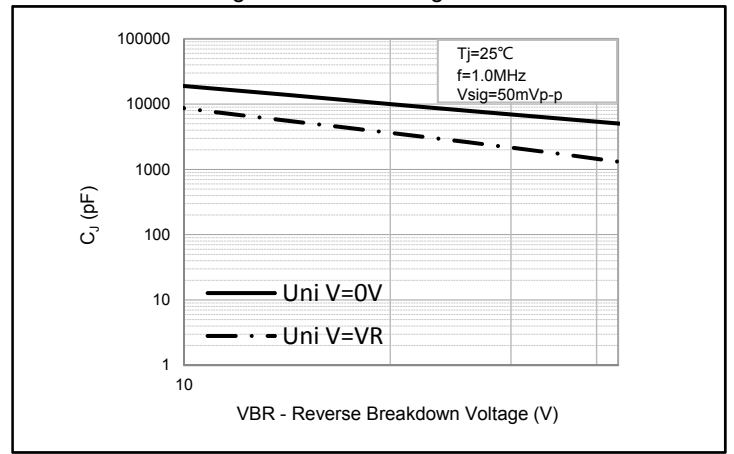

Fig.4 - Typical Junction Capacitance

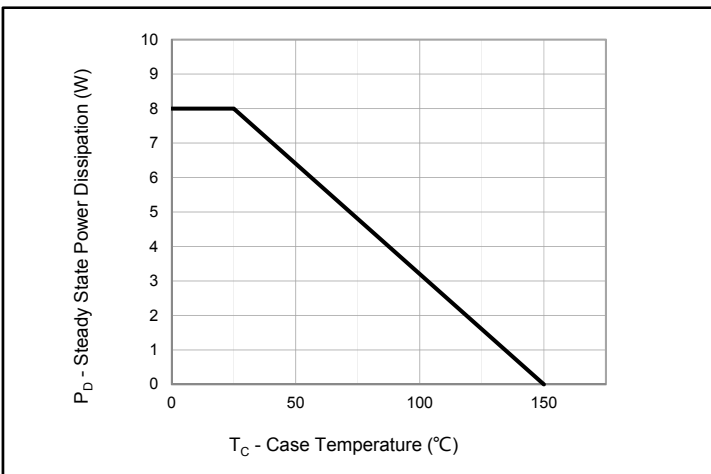

Fig.5 - Steady State Power Dissipation Derating Curve

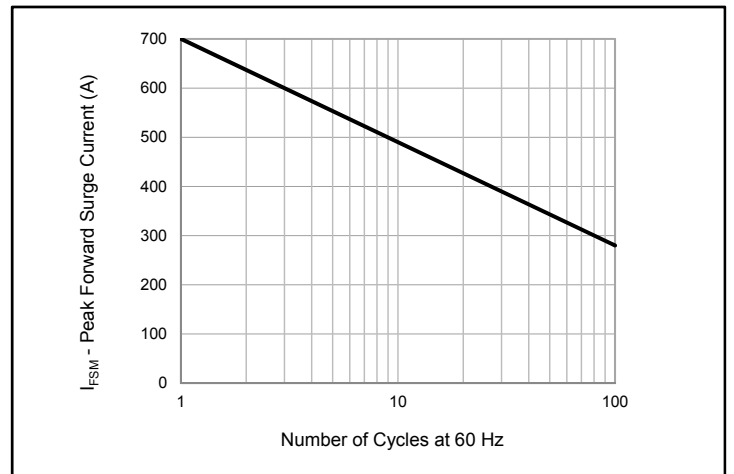
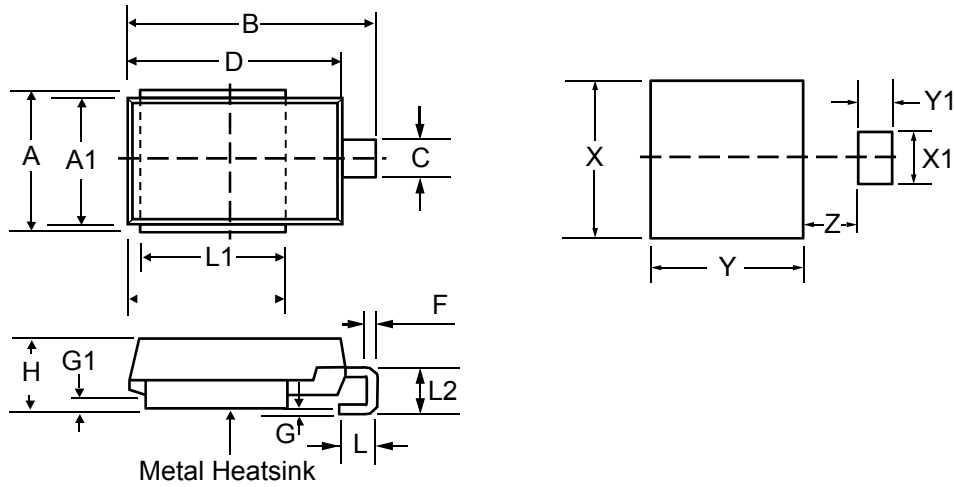

Fig.6 - Maximum Non-Repetitive Peak Forward Surge Current

»Package Dimensions



DO-218						
Dimension	Inches			Millimeters		
	MIN	NOM	MAX	MIN	NOM	MAX
A	0.374	0.394	0.413	9.5	10	10.5
A1	0.327	0.335	0.343	8.3	8.5	8.7
B	0.591	0.614	0.63	15	15.6	16
C	0.094	0.106	0.118	2.4	2.7	3
D	0.524	0.531	0.539	13.3	13.5	13.7
F	0.02	0.024	0.028	0.5	0.6	0.7
G	-		0.008	-		0.2
G1		0.02			0.5	
H	0.185	0.191	0.197	4.7	4.85	5
L	0.059	0.079	0.098	1.5	2	2.5
L1	0.343	0.354	0.366	8.7	9	9.3
L2	0.098	0.118	0.138	2.5	3	3.5
X		0.394			10	
Y		0.354			9	
Z		0.138			3.5	
X1		0.106			2.7	
Y1		0.079			2	

»Marking Code

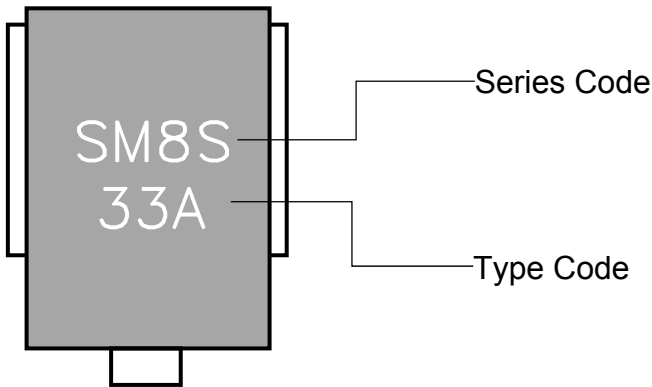

»Tape and Reel Specification

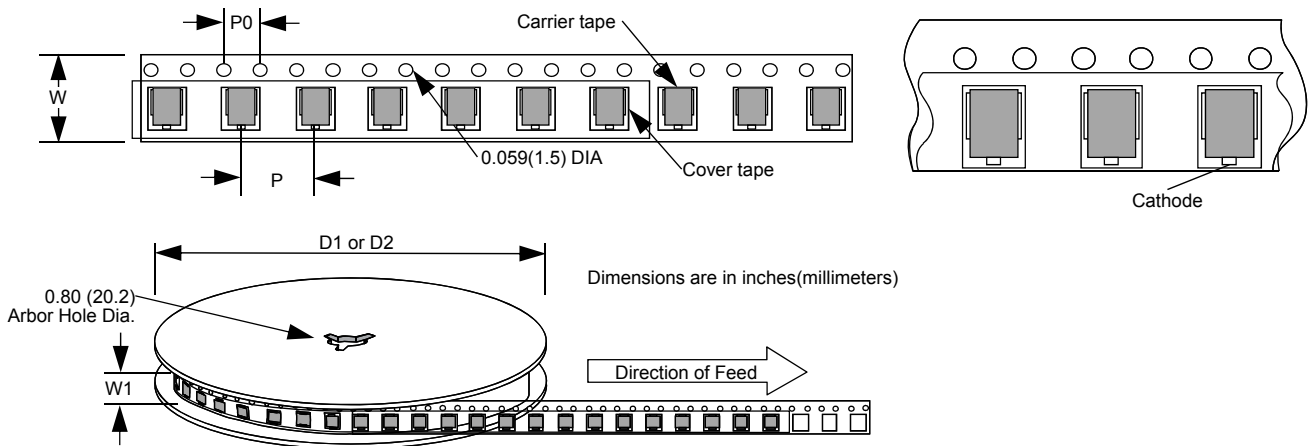

Dimension	Inches			Millimeters		
	MIN	NOM	MAX	MIN	NOM	MAX
P		0.63			16	
P0		0.157			4	
W		0.945			24	
W1		0.965			24.5	
D1		7			177.8	
D2		13			330.2	