



WF200DPZ 0.05BG S16 DT Digital Pressure Sensor

Features

- Supply voltage: 1.8V ~ 3.6V
- Package: SOIC-16
Footprint: 10.3 × 10.3mm
Height: 10.3mm
- Supply voltage: 1.8V to 3.6V
- Relative accuracy: $\pm 0.03\text{hPa}(\pm 0.25\text{m})$
Absolute accuracy: Typ. $\pm 1.5\text{hPa}$
- Integrated digital pressure sensor (24 bit $\Delta\Sigma$ ADC)
- SPI / I2C serial interface
- Current consumption: 3.5 μA @1Hz
- Operation Range -50 ~ 50 hPa, -20 to +85 °C
- RoHs compliant, halogen-free

Applications

- Barometer and altimeter for portable Devices
- Indoor and outdoor navigation
- Weather station equipment
- Multisport watches
- Drones and other autonomous vehicles
- Fitness trackers

Technical advantages

- Wide temperature: -20~+85°C
- Small package, height only 3.3mm
- Excellent performance and cost

Brief Description

- WF200D is a high precision barometer timer especially designed for consumer applications. It measures the pressure based on piezo-resistive MEMS pressure sensor.
- Optimized for ultra-low power and low voltage for use in mobile phones, smart watches, PDAs, GPS navigation devices and outdoor equipment.
- The sensor module is housed in a compact 16-pin SOIC package with a footprint of only 10.3 × 10.3 mm and 10.3 mm package height. Its small dimensions and its low power consumption allow the implementation in battery driven devices. With a low altitude noise of merely 0.08m and very low offset temperature coefficient(TCO), the offers superior performance and cost are perfectly suitable for applications like flying toys and sport watches.
- The IIC/SPI interface allows for easy system integration with a microcontroller.



PERFORMANCE SPECIFICATIONS

- ABSOLUTE MAXIMUM RATINGS (VDD = 3.3V, T = 25°C UNLESS OTHERWISE NOTED)

Parameter	Symbol	Condition	Min	Typ.	Max	Unit
Supply voltage	V _{DD}		-0.3		+4	V
Storage temperature	T _s		-40		+85	°C
Overpressure	P _{max}	ISO 22810			4X	
Maximum Soldering Temperature	T _{max}	40 sec. max			260	°C
ESD rating		Human Body Model	-2		+2	kV

- ELECTRICAL CHARACTERISTICS (VDD = 3.3V, T = 25°C UNLESS OTHERWISE NOTED)

Parameter	Symbol	Condition	Min	Typ.	Max	Unit
Operating Supply voltage	V _{DD}		1.8	3.3	3.6	V
Operating Temperature	T		-20	+25	+85	°C
Peak supply current		during conversion		1.25		mA
Supply current (1 sample per sec.)	I _{DD}	OSR				μA
		8192		21.09		
		4096		11.05		
		2048		6.02		
		1024		3.51		
		512		2.26		
		256		1.63		
Standby supply current		at 25°C (V _{DD} = 3.3 V)		0.01	0.1	μA
VDD Capacitor		from VDD to GND	100	470		nF



I2C INTERFACE

I2C bus uses SCL and SDA as signal lines. Both lines are connected to VDDIO externally via pull-up resistors so that they are pulled high when the bus is free. The I2C device address of is shown below. The LSB bit of the 7bits device address is configured via SDO/ADDR pin.

● IIC Device Address

	Device Address							IIC W/R
	Bit7	Bit6	Bit5	Bit4	Bit3	Bit2	Bit1	Bit0
Default	1	1	0	1	1	0	1	0/1
Custom	1	1	0	1	1	0	SDO/ADDR	0/1

● Electrical specification of the I2C interface pins

Symbol	Parameter	Min	Max	Unit
f _{SCL}	Clock frequency		400	kHz
t _{LOW}	SCL low pulse	1.3		μs
t _{HIGH}	SCL high pulse	0.6		μs
t _{SUDAT}	SDA setup time	0.1		μs
t _{HDDAT}	SDA hold time	0.0		μs
t _{SUSTA}	Setup Time for a repeated start condition	0.6		μs
t _{HDSTA}	Hold time for a start condition	0.6		μs
t _{SUSTO}	Setup Time for a stop condition	0.6		μs
t _{BUF}	Time before a new transmission can start	1.3		μs

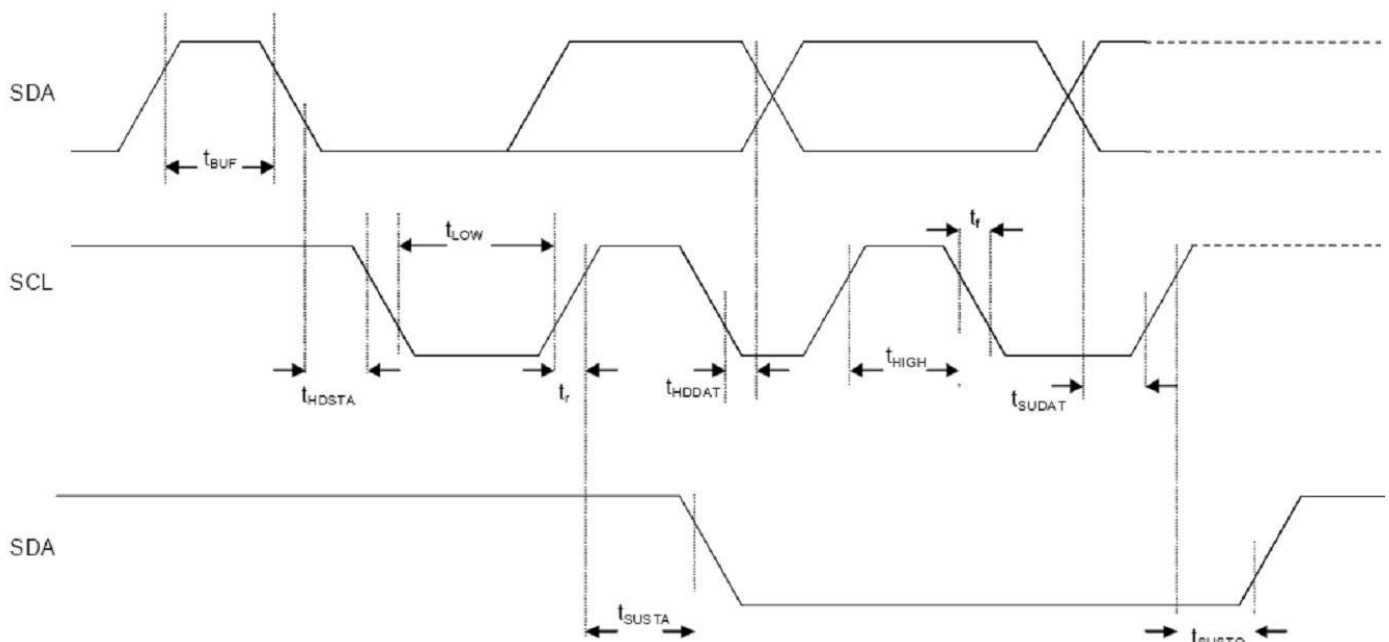



The I2C interface protocol has special bus signal conditions. Start (S), stop (P) and binary data conditions are shown below. At start condition, SCL is high and SDA has a falling edge. Then the slave address is sent. After the 7 address bits, the direction control bit R/W selects the read or write operation. When a slave device recognizes that it is being addressed, it should acknowledge by pulling SDA low in the ninth SCL (ACK) cycle. At stop condition, SCL is also high, but SDA has a rising edge. Data must be held stable at SDA when SCL is high. Data can change value at SDA only when SCL is low.

● IIC Protocol

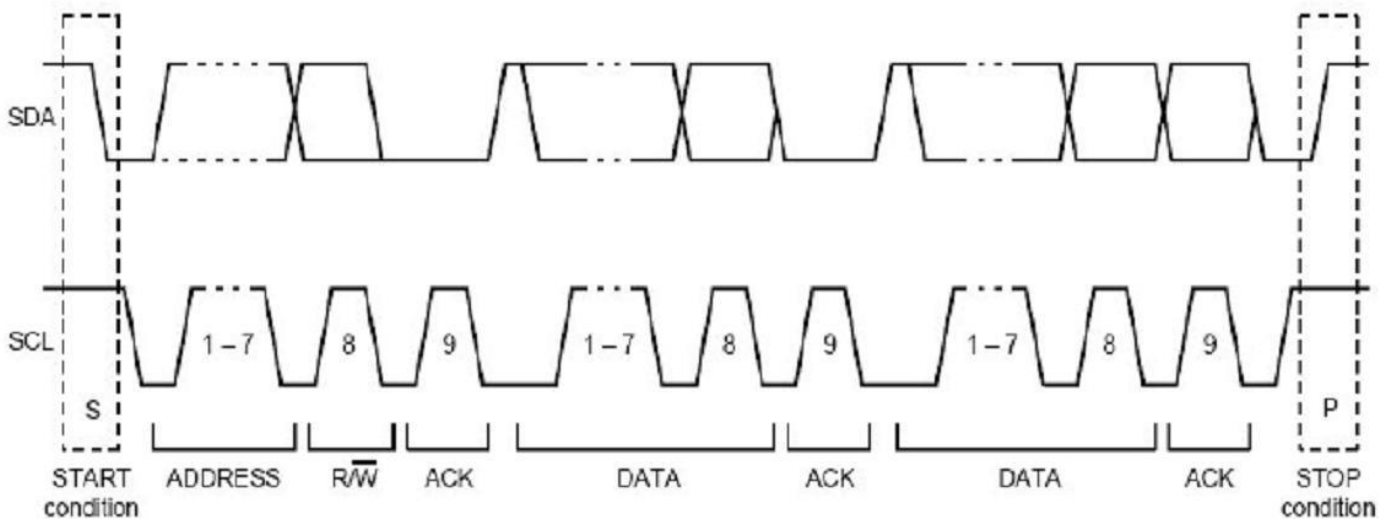



PRESSURE AND TEMPERATURE CALCULATIO

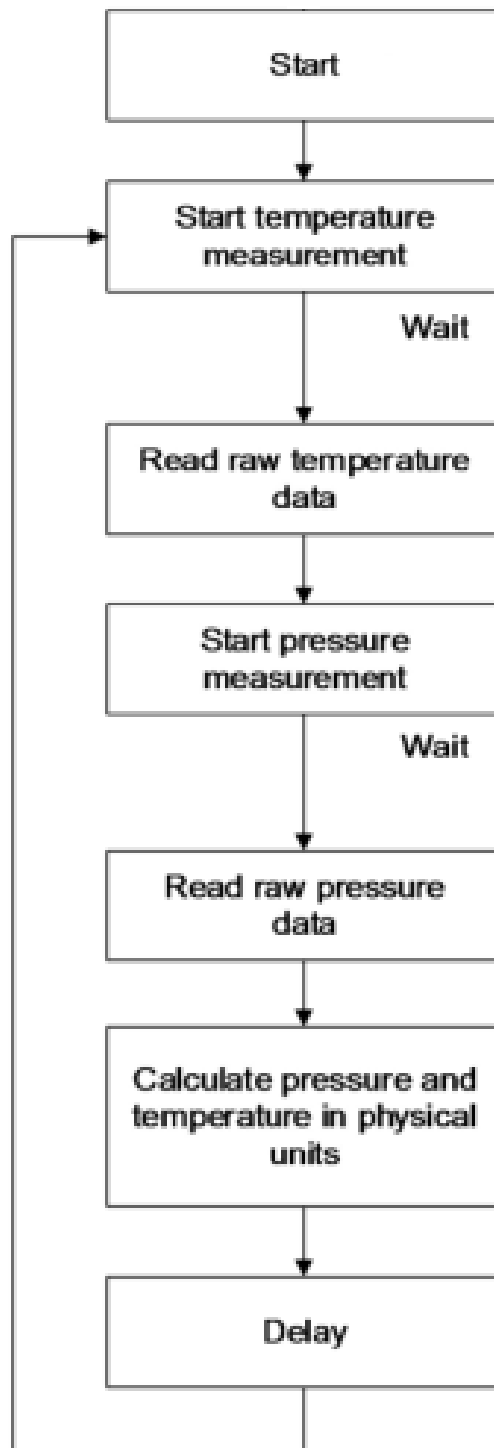



WF200DPZ 0.05BG S16 DT Digital Pressure Sensor

Start

T_{MIN} = -40°C T_{MAX} = 85°C T_{REF} = 25°C



Read digital pressure and temperature data

Reg	Description		R/W	Default
0x30	CMD	Measurement_control<3:0>: 1000b, indicate a single shot temperature signal conversion. 1001b, indicate a single shot sensor signal conversion. 1010b: indicate a combined conversion (once temperature conversion immediately followed by once sensor signal conversion).	RW	0x00
0x06	PRESSURE_MSB	Data out<23:16>	R	0x00
0x07	PRESSURE_CSB	Data out<15:8>	R	0x00
0x08	PRESSURE_LSB	Data out<7:0>	R	0x00
0x09	TEMP_MSB	Temp out<15:8>	R	0x00
0x0A	TEMP_LSB	Temp out<7:0>	R	0x00

*Reg0x06-Reg0x08: 24 bits ADC output data with an LSB

*Reg0x09-Reg0x0A: Temperature output with an LSB



Calculate

	Size [bit]	Zero Condition	Below Zero	Above Zero
PRESSURE	24	8388608	$=((\text{PRESSURE_MSB} \ll 16) \& (\text{PRESSURE_CSB} \ll 8) \& \& \text{PRESSURE_LSB}) / 8388608$	$=(((\text{PRESSURE_MSB} \ll 16) \& (\text{PRESSURE_CSB} \ll 8) \& \& \text{PRESSURE_LSB}) - 16777216) / 8388608$
TEMP	16	32768	$=((\text{TEMP_MSB} \ll 8) \& \text{TEMP_LSB}) / 256$	$=(((\text{TEMP_MSB} \ll 8) \& \text{TEMP_LSB}) - 65536) / 256$

* PRESSURE: It also needs to be converted according to the pressure range, Using the driver C code is strongly recommended. Please contact with WFH for details.



● IIC timing diagram

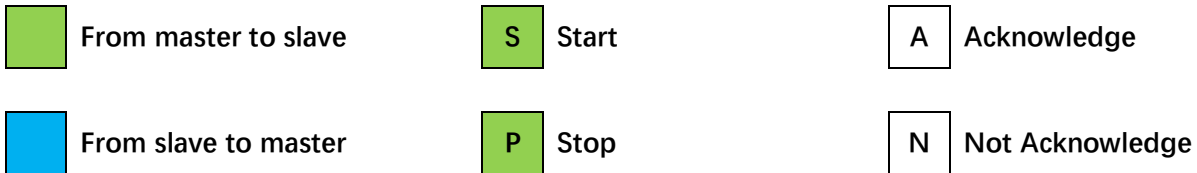

Write Data (IIC Write)



(a) temperature conversion command

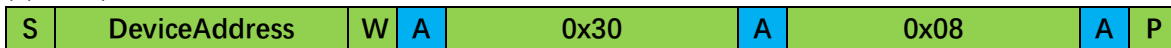

(b) pressure conversion command

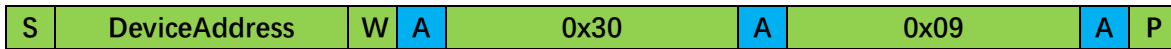

Read Data (IIC Read)

(a) After sending the temperature conversion command, read 16bit data from the output buffer

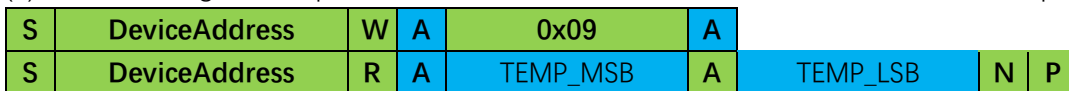

(b) After sending the pressure conversion command, read 24bit data from the output buffer

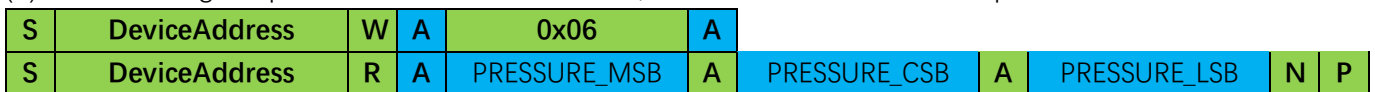



APPLICATION CIRCUIT

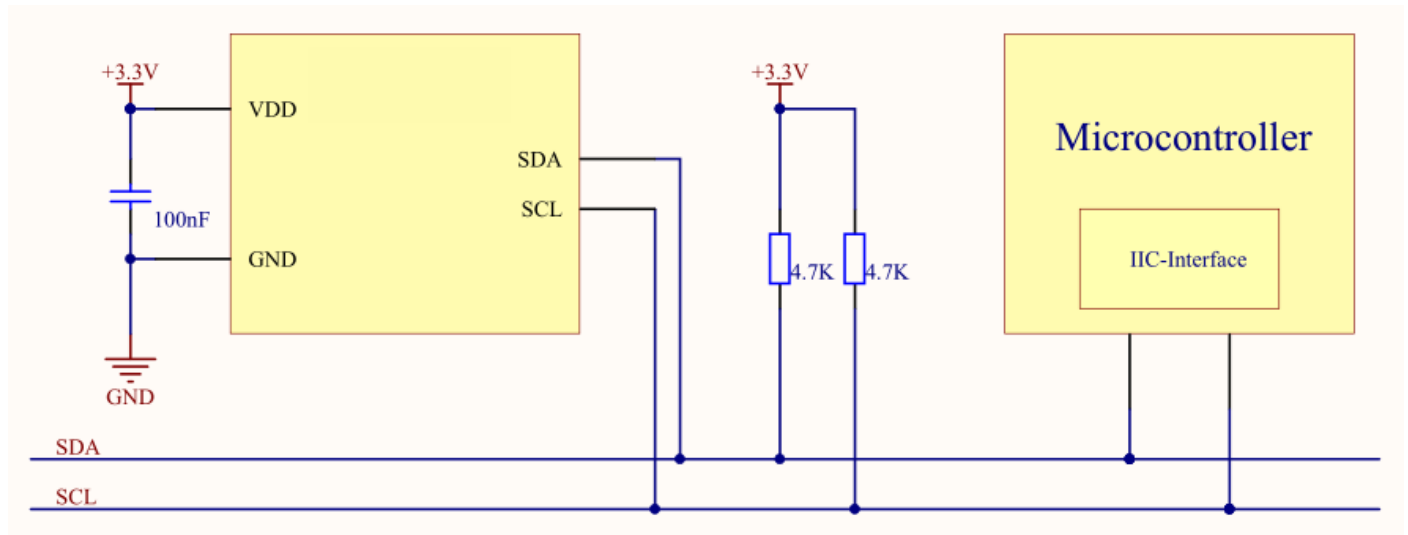

PIN CONFIGURATION AND DEVICE PACKAGE OUTLINE

● Package Information

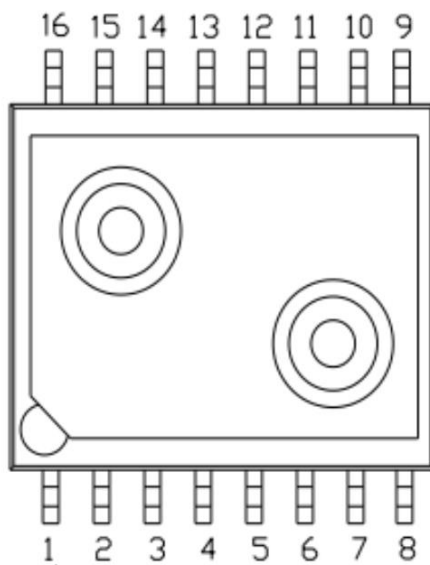

Top View

Pin	Name	Function
1		
2		
3		
4		
5	VDD	Positive supply voltage
6	INT	Data ready
7	CSB	Chip select
8		
9		
10	SDA	Serial data
11	SCL	Serial data clock
12	SDO	Address select in I2C mode
13	GND	Ground
14		
15		
16		



- Pin Configuration (Notes: Mechanical dimension is mm)

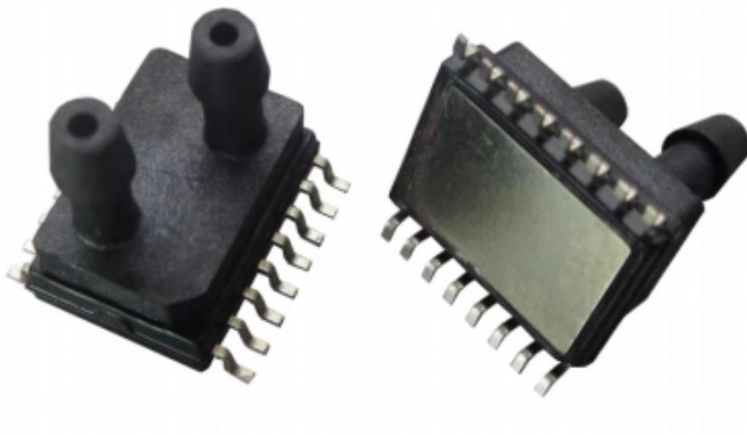



WF200DPZ 0.05BG S16 DT Digital Pressure Sensor

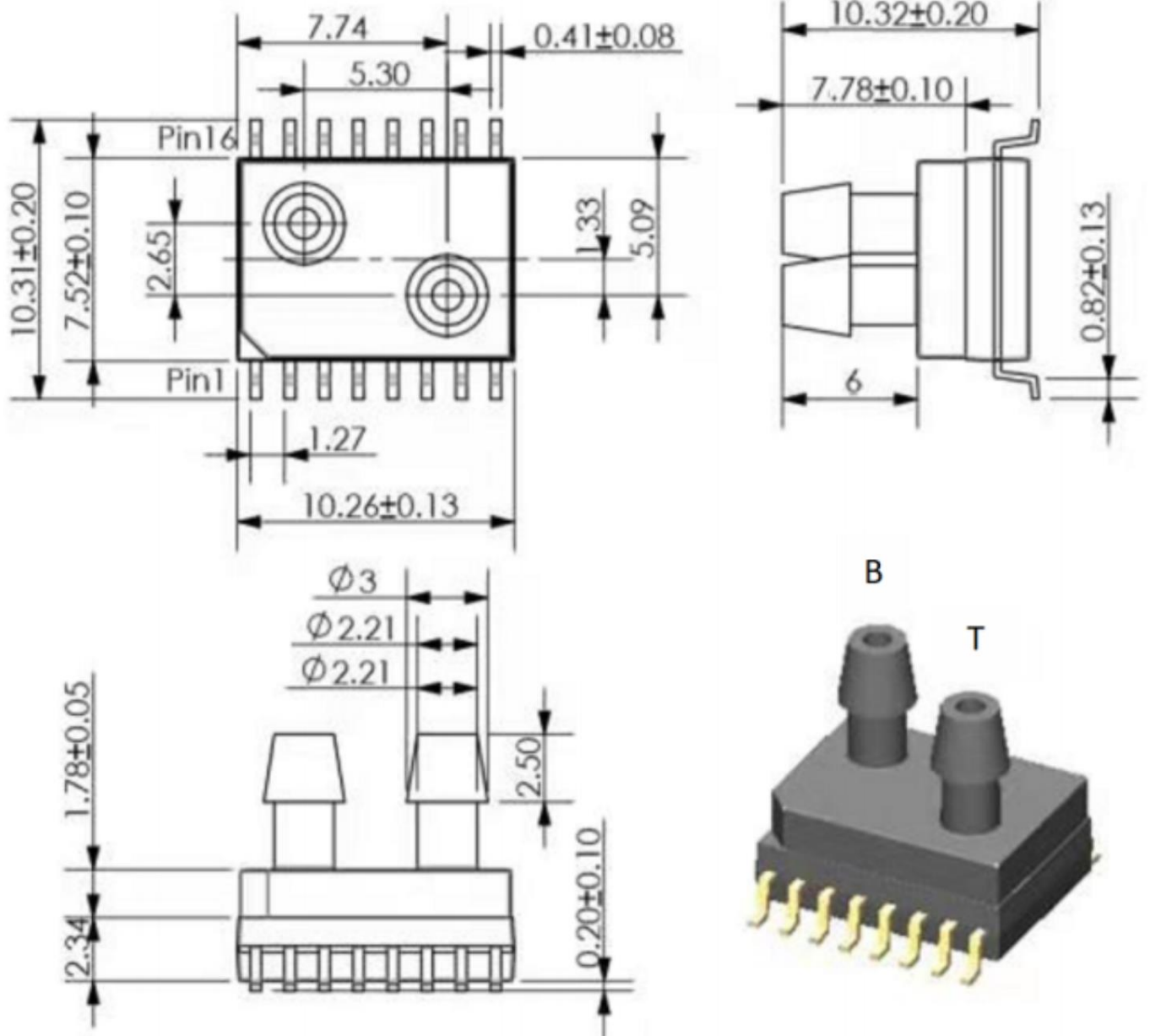



● Shipping Package

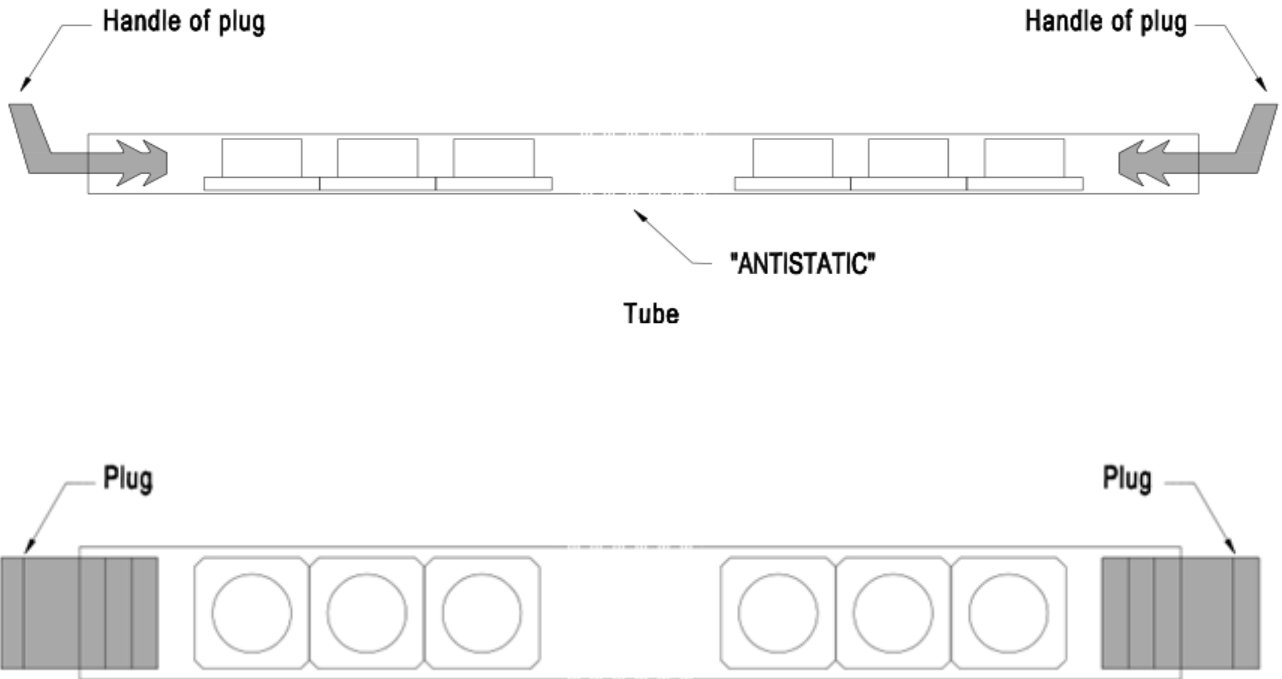



● Soldering recommendation

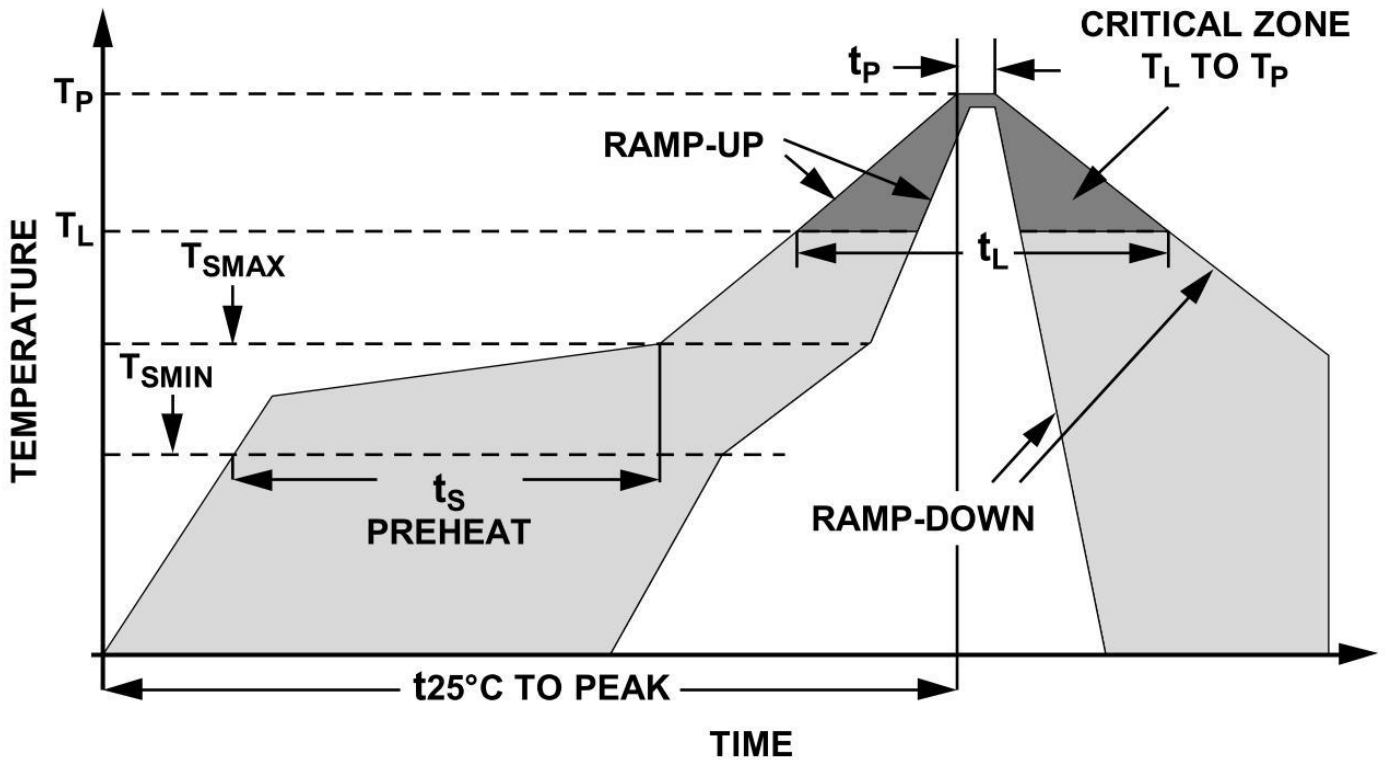

● Recommended Soldering Profile

Profile Feature	Pb-Free
Average ramp-up rate(\$T_{sMax}\$ to \$T_P\$)	3°C/sec max.
Preheat: -Temperature Min.(\$T_{sMin}\$) -Temperature Max.(\$T_{sMax}\$) -Time.(\$T_{sMin}\$ to \$T_{sMax}\$)(\$T_s\$)	150°C 200°C 60 sec to 180 sec
Time maintained above: -Temperature(\$T_L\$) -Time(\$t_L\$)	217°C 60 sec to 150 sec
Peak temperature(\$T_P\$)	260°C
Time within 5°C of actual peak temperature(\$T_P\$)	20 sec to 40 sec
Ramp-down rate	4°C/sec max.
Time 25°C to peak temperature	8minutes max.