



Surface mount transient voltage suppressor power 600 watts

Stand-Off Voltage : 5.0~440V

FEATURES

- For surface mounted applications in order to optimize board space.
- Low profile package
- Glass passivated junction
- Low inductance
- Plastic package has Underwriters Laboratory Flammability

MECHANICAL DATA

- Case: SMAF
- Terminals: Solderable per MIL-STD-750, Method 2026
- Approx. Weight: 27mg 0.00095oz

PINNING

PIN	DESCRIPTION
1	Cathode
2	Anode

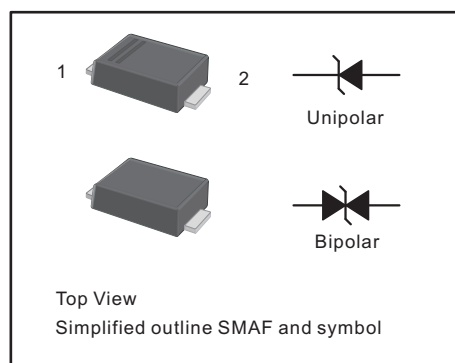

Maximum Ratings and Electrical characteristics

Ratings at 25 °C ambient temperature unless otherwise specified.

Parameter	Symbol	Value	Unit
Peak Pulse Power Dissipation (Non repetitive current pulse derated above T = 25°C) (Note 1)	P_{pk}	600	W
Peak Forward Surge Current, 8.3ms Single Half Sine Wave Superimposed on Rated Load (JEDEC Method) (Note 1,2, & 3)	I_{FSM}	100	A
Instantaneous Forward Voltage @ $I_F=35A$ $V_{BR}<100V$ $V_{BR}\geq 100V$	V_F	3.5 5.0	V
Operating Junction Temperature and Storage Temperature Range	T_j, T_{stg}	-55 ~ +150	°C

NOTES:

1. Valid provided that terminals are kept at ambient temperature.
2. Measured with 8.3ms single half sine-wave. Duty cycle = 4 pulses per minute maximum.
3. Unidirectional units only.



Characteristics at Ta = 25°C

Type		Reverse Stand-off Voltage	Breakdown Voltage		Test Current	Reverse Leakage	Max. Clamp Voltage	Peak Pulse Current
			V _{BR} @ I _T					
			V _{RRM}	Min	Max	I _T	I _R @ V _{RRM}	V _C @ I _{PP}
UNI	BI	V	V	V	mA	µA	V	A
P6SMAFJ5.0	P6SMAFJ5.0C	5	6.4	7.55	10	800	9.6	62.5
P6SMAFJ5.0A	P6SMAFJ5.0CA	5	6.4	7.25	10	800	9.2	65.2
P6SMAFJ6.0	P6SMAFJ6.0C	6	6.67	8.45	10	800	11.4	52.6
P6SMAFJ6.0A	P6SMAFJ6.0CA	6	6.67	7.67	10	800	10.3	58.3
P6SMAFJ6.5	P6SMAFJ6.5C	6.5	7.22	9.14	10	500	12.3	48.8
P6SMAFJ6.5A	P6SMAFJ6.5CA	6.5	7.22	8.3	10	500	11.2	53.6
P6SMAFJ7.0	P6SMAFJ7.0C	7	7.78	9.86	10	200	13.3	45.1
P6SMAFJ7.0A	P6SMAFJ7.0CA	7	7.78	8.95	10	200	12	50
P6SMAFJ7.5	P6SMAFJ7.5C	7.5	8.33	10.67	1	100	14.3	42
P6SMAFJ7.5A	P6SMAFJ7.5CA	7.5	8.33	9.58	1	100	12.9	46.5
P6SMAFJ8.0	P6SMAFJ8.0C	8	8.89	11.3	1	50	15	40
P6SMAFJ8.0A	P6SMAFJ8.0CA	8	8.89	10.23	1	50	13.6	44.1
P6SMAFJ8.5	P6SMAFJ8.5C	8.5	9.44	11.92	1	20	15.9	37.7
P6SMAFJ8.5A	P6SMAFJ8.5CA	8.5	9.44	10.82	1	20	14.4	41.7
P6SMAFJ9.0	P6SMAFJ9.0C	9	10	12.6	1	10	16.9	35.5
P6SMAFJ9.0A	P6SMAFJ9.0CA	9	10	11.5	1	10	15.4	39
P6SMAFJ10	P6SMAFJ10C	10	11.1	14.1	1	5	18.8	31.9
P6SMAFJ10A	P6SMAFJ10CA	10	11.1	12.8	1	5	17	35.3
P6SMAFJ11	P6SMAFJ11C	11	12.2	15.4	1	5	20.1	29.9
P6SMAFJ11A	P6SMAFJ11CA	11	12.2	14	1	5	18.2	33
P6SMAFJ12	P6SMAFJ12C	12	13.3	16.9	1	5	22	27.3
P6SMAFJ12A	P6SMAFJ12CA	12	13.3	15.3	1	5	19.9	30.2
P6SMAFJ13	P6SMAFJ13C	13	14.4	18.2	1	5	23.8	25.2
P6SMAFJ13A	P6SMAFJ13CA	13	14.4	16.5	1	5	21.5	27.9
P6SMAFJ14	P6SMAFJ14C	14	15.6	19.8	1	5	25.8	23.3
P6SMAFJ14A	P6SMAFJ14CA	14	15.6	17.9	1	5	23.2	25.9
P6SMAFJ15	P6SMAFJ15C	15	16.7	21.1	1	5	26.9	22.3
P6SMAFJ15A	P6SMAFJ15CA	15	16.7	19.2	1	5	24.4	24.6
P6SMAFJ16	P6SMAFJ16C	16	17.8	22.6	1	5	28.8	20.8
P6SMAFJ16A	P6SMAFJ16CA	16	17.8	20.5	1	5	26	23.1
P6SMAFJ17	P6SMAFJ17C	17	18.9	23.9	1	5	30.5	19.7
P6SMAFJ17A	P6SMAFJ17CA	17	18.9	21.7	1	5	27.6	21.7
P6SMAFJ18	P6SMAFJ18C	18	20	25.3	1	5	32.2	18.6
P6SMAFJ18A	P6SMAFJ18CA	18	20	23.3	1	5	29.2	20.5
P6SMAFJ20	P6SMAFJ20C	20	22.2	28.1	1	5	35.8	16.8
P6SMAFJ20A	P6SMAFJ20CA	20	22.2	25.5	1	5	32.4	18.5
P6SMAFJ22	P6SMAFJ22C	22	24.4	30.9	1	5	39.4	15.2
P6SMAFJ22A	P6SMAFJ22CA	22	24.4	28	1	5	35.5	16.9
P6SMAFJ24	P6SMAFJ24C	24	26.7	33.8	1	5	43	14
P6SMAFJ24A	P6SMAFJ24CA	24	26.7	30.7	1	5	38.9	15.4
P6SMAFJ26	P6SMAFJ26C	26	28.9	36.6	1	5	46.6	12.9
P6SMAFJ26A	P6SMAFJ26CA	26	28.9	33.2	1	5	42.1	14.3
P6SMAFJ28	P6SMAFJ28C	28	31.1	39.4	1	5	50	12
P6SMAFJ28A	P6SMAFJ28CA	28	31.1	35.8	1	5	45.4	13.2
P6SMAFJ30	P6SMAFJ30C	30	33.3	42.2	1	5	53.5	11.2
P6SMAFJ30A	P6SMAFJ30CA	30	33.3	38.3	1	5	48.4	12.4
P6SMAFJ33	P6SMAFJ33C	33	36.7	46.5	1	5	59	10.2
P6SMAFJ33A	P6SMAFJ33CA	33	36.7	42.2	1	5	53.3	11.3
P6SMAFJ36	P6SMAFJ36C	36	40	50.7	1	5	64.3	9.3
P6SMAFJ36A	P6SMAFJ36CA	36	40	46	1	5	58.1	10.3
P6SMAFJ40	P6SMAFJ40C	40	44.4	56.3	1	5	71.4	8.4
P6SMAFJ40A	P6SMAFJ40CA	40	44.4	51.1	1	5	64.5	9.3
P6SMAFJ43	P6SMAFJ43C	43	47.8	60.5	1	5	76.7	7.8
P6SMAFJ43A	P6SMAFJ43CA	43	47.8	54.9	1	5	69.4	8.6
P6SMAFJ45	P6SMAFJ45C	45	50	63.3	1	5	80.3	7.5



Characteristics at Ta = 25°C

Type		Reverse Stand-off Voltage	Breakdown Voltage		Test Current	Reverse Leakage	Max. Clamp Voltage	Peak Pulse Current
			V _{BR} @ I _T					
		V _{RRM}	Min	Max	I _T	I _R @ V _{RRM}	V _C @ I _{PP}	I _{PP}
UNI	BI	V	V	V	mA	μA	V	A
P6SMAFJ45A	P6SMAFJ45CA	45	50	57.5	1	5	72.7	8.3
P6SMAFJ48	P6SMAFJ48C	48	53.3	67.5	1	5	85.5	7
P6SMAFJ48A	P6SMAFJ48CA	48	53.3	61.3	1	5	77.4	7.8
P6SMAFJ51	P6SMAFJ51C	51	56.7	71.8	1	5	91.1	6.6
P6SMAFJ51A	P6SMAFJ51CA	51	56.7	65.2	1	5	82.4	7.3
P6SMAFJ54	P6SMAFJ54C	54	60	76	1	5	96.3	6.2
P6SMAFJ54A	P6SMAFJ54CA	54	60	69	1	5	87.1	6.9
P6SMAFJ58	P6SMAFJ58C	58	64.4	81.6	1	5	103	5.8
P6SMAFJ58A	P6SMAFJ58CA	58	64.4	74.1	1	5	93.6	6.4
P6SMAFJ60	P6SMAFJ60C	60	66.7	84.5	1	5	107	5.6
P6SMAFJ60A	P6SMAFJ60CA	60	66.7	76.7	1	5	96.8	6.2
P6SMAFJ64	P6SMAFJ64C	64	71.1	90.1	1	5	114	5.3
P6SMAFJ64A	P6SMAFJ64CA	64	71.1	81.8	1	5	103	5.8
P6SMAFJ70	P6SMAFJ70C	70	77.8	98.6	1	5	125	4.8
P6SMAFJ70A	P6SMAFJ70CA	70	77.8	89.5	1	5	113	5.3
P6SMAFJ75	P6SMAFJ75C	75	83	105.7	1	5	134	4.5
P6SMAFJ75A	P6SMAFJ75CA	75	83	95.8	1	5	121	5
P6SMAFJ78	P6SMAFJ78C	78	86	109.8	1	5	139	4.3
P6SMAFJ78A	P6SMAFJ78CA	78	86	99.7	1	5	126	4.8
P6SMAFJ85	P6SMAFJ85C	85	94	119.2	1	5	151	4
P6SMAFJ85A	P6SMAFJ85CA	85	94	108.2	1	5	137	4.4
P6SMAFJ90	P6SMAFJ90C	90	100	126.5	1	5	160	3.8
P6SMAFJ90A	P6SMAFJ90CA	90	100	115.5	1	5	146	4.1
P6SMAFJ100	P6SMAFJ100C	100	111	141	1	5	179	3.4
P6SMAFJ100A	P6SMAFJ100CA	100	111	128	1	5	162	3.7
P6SMAFJ110	P6SMAFJ110C	110	122	154.5	1	5	196	3.1
P6SMAFJ110A	P6SMAFJ110CA	100	122	140.5	1	5	177	3.4
P6SMAFJ120	P6SMAFJ120C	120	133	169	1	5	214	2.8
P6SMAFJ120A	P6SMAFJ120CA	120	133	153	1	5	193	3.1
P6SMAFJ130	P6SMAFJ130C	130	144	182.5	1	5	231	2.6
P6SMAFJ130A	P6SMAFJ130CA	130	144	165.5	1	5	209	2.9
P6SMAFJ150	P6SMAFJ150C	150	167	211.5	1	5	268	2.2
P6SMAFJ150A	P6SMAFJ150CA	150	167	192.5	1	5	243	2.5
P6SMAFJ160	P6SMAFJ160C	160	178	226	1	5	287	2.1
P6SMAFJ160A	P6SMAFJ160CA	160	178	205	1	5	259	2.3
P6SMAFJ170	P6SMAFJ170C	170	189	239.5	1	5	304	2
P6SMAFJ170A	P6SMAFJ170CA	170	189	217.5	1	5	275	2.2
P6SMAFJ180	P6SMAFJ180C	180	200	253.8	1	5	321	1.9
P6SMAFJ180A	P6SMAFJ180CA	180	200	230.4	1	5	290	2.1
P6SMAFJ190	P6SMAFJ190C	190	211	267.9	1	5	339	1.8
P6SMAFJ190A	P6SMAFJ190CA	190	211	243.2	1	5	306	2
P6SMAFJ200	P6SMAFJ200C	200	222	282	1	5	356	1.7
P6SMAFJ200A	P6SMAFJ200CA	200	222	256	1	5	322	1.9
P6SMAFJ210	P6SMAFJ210C	210	233	296.1	1	5	375	1.6
P6SMAFJ210A	P6SMAFJ210CA	210	233	268.8	1	5	339	1.8



Characteristics at Ta = 25°C

Type		Reverse Stand-off Voltage	Breakdown Voltage		Test Current	Reverse Leakage	Max. Clamp Voltage	Peak Pulse Current
			V _{BR} @ I _T					
		V _{R_{RM}}	Min	Max	I _T	I _R @ V _{R_{RM}}	V _C @ I _{PP}	I _{PP}
UNI	BI	V	V	V	mA	μA	V	A
P6SMAFJ220	P6SMAFJ220C	220	244	310.2	1	5	392	1.5
P6SMAFJ220A	P6SMAFJ220CA	220	244	281.6	1	5	355	1.7
P6SMAFJ250	P6SMAFJ250C	250	278	342.5	1	5	447	1.3
P6SMAFJ250A	P6SMAFJ250CA	250	278	309	1	5	403	1.5
P6SMAFJ300	P6SMAFJ300C	300	333	411	1	5	535	1.1
P6SMAFJ300A	P6SMAFJ300CA	300	333	371	1	5	484	1.2
P6SMAFJ350	P6SMAFJ350C	350	389	479.5	1	5	624	1
P6SMAFJ350A	P6SMAFJ350CA	350	389	432	1	5	565	1.1
P6SMAFJ400	P6SMAFJ400C	400	444	548	1	5	687	0.9
P6SMAFJ400A	P6SMAFJ400CA	400	444	494	1	5	645	0.9
P6SMAFJ440	P6SMAFJ440C	440	489	602.8	1	5	786	0.8
P6SMAFJ440A	P6SMAFJ440CA	440	489	543	1	5	710	0.8

Note:

- (1) V_{BR} measured after I_T applied for 300 μs., I_T square wave pulse or equivalent.
- (2) Surge Current Waveform per Figure 5 and Derate per Figure 1
- (3) A Transient suppressor is normally selected according to the reverse " Stand-off Voltage " (V_{WM}) which should be equal to or greater then the D.C. or continuous peak operating voltage level.



Ratings and Characteristic Curves TA = 25°C unless otherwise noted

Fig.1 Peak Pulse Power Rating Curve

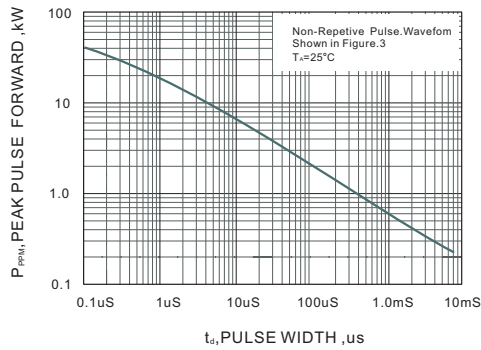

Fig.2 Forward Current Derating Curve

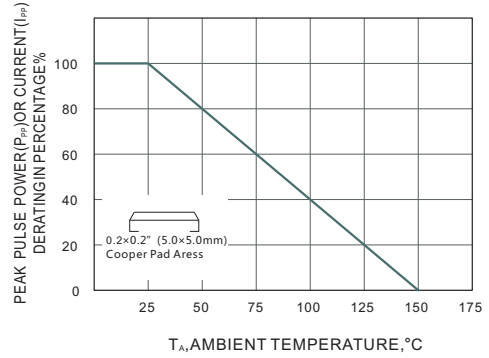

Fig.3 Pulse Waveform

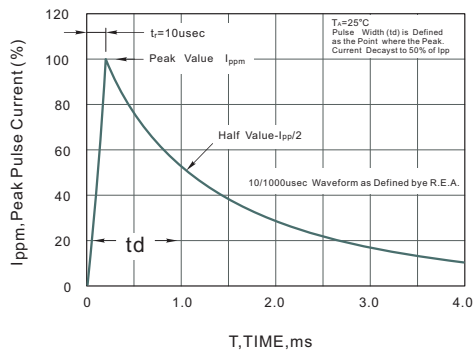

Fig.4 Maximum Non-Repetitive Peak Forward Surge Current

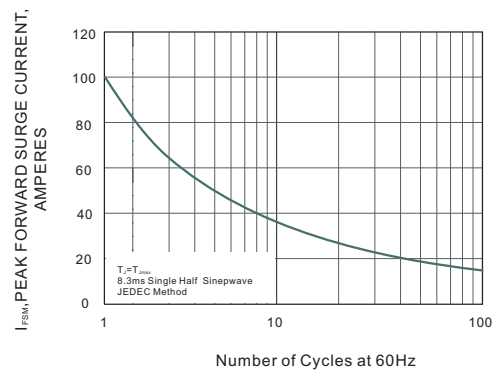
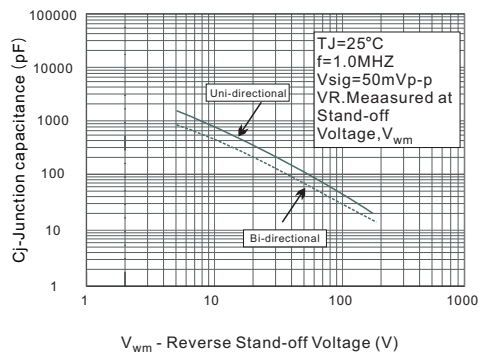

Fig.5 Typical Junction Capacitance





PACKAGE OUTLINE

Plastic surface mounted package; 2 leads

SMAF

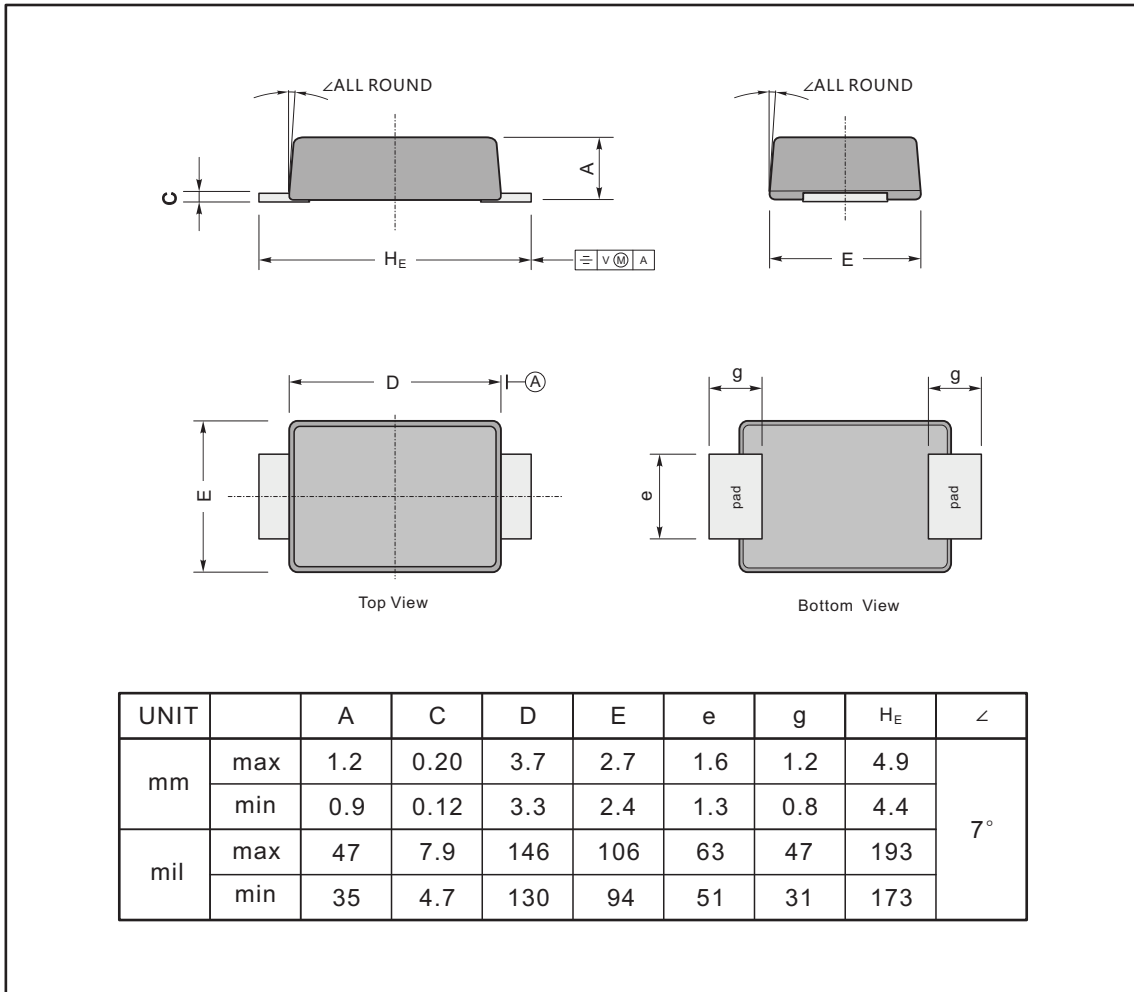

The recommended mounting pad size

