

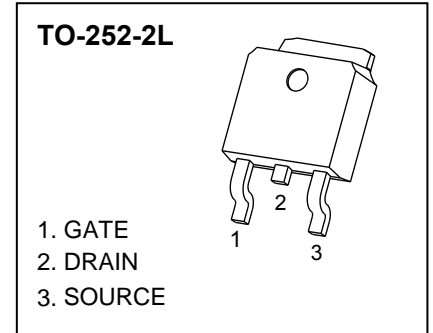

**TO-252-2L Plastic-Encapsulate MOSFETS**

**CJU30P10 P-Channel Power MOSFET**

$V_{(BR)DSS}$	$R_{DS(on)}$ TYP	$I_D$
-100V	38mΩ@-10V	-30A
	41mΩ@-4.5V	



**GENERAL DESCRIPTION**

The CJU30P10 uses advanced trench technology and design to provide excellent  $R_{DS(on)}$  with low gate charge. It can be used in a wide variety of applications.

**FEATURE**

- Advanced trench process technology
- Reliable and rugged
- High density cell design for ultra low On-Resistance

**APPLICATION**

- Power management in notebook computer
- Portable equipment and battery powered systems

**MARKING**

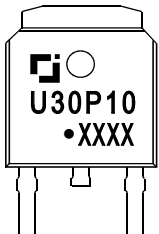

U30P10 = Device code.  
 Solid dot = Green molding compound device.  
 if none, the normal device.  
 XXXX = Code.

**EQUIVALENT CIRCUIT**

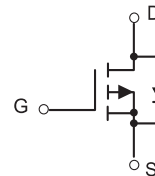

**MAXIMUM RATINGS (  $T_a=25^\circ\text{C}$  unless otherwise noted )**

Parameter	Symbol	Limit	Unit
Drain-Source Voltage	$V_{DS}$	-100	V
Gate-Source Voltage	$V_{GS}$	±20	V
Continuous Drain Current	$I_D$	-30	A
Pulsed Drain Current	$I_{DM}$	-120	A
Single Pulsed Avalanche Energy	$E_{AS}$	240	mJ
Power Dissipation	$P_D$ ①	108	W
Thermal Resistance from Junction to Ambient	$R_{\theta JA}$	100	$^\circ\text{C/W}$
Thermal Resistance from Junction to Case	$R_{\theta JC}$	1.15	$^\circ\text{C/W}$
Junction Temperature and Storage Temperature Range	$T_J$ $T_{stg}$	-55 ~+150	$^\circ\text{C}$

# MOSFET ELECTRICAL CHARACTERISTICS

$T_a=25\text{ }^\circ\text{C}$  unless otherwise specified

Parameter	Symbol	Test Condition	Min	Typ	Max	Unit
<b>Off characteristics</b>						
Drain-source breakdown voltage	$V_{(BR)DSS}$	$V_{GS}=0V, I_D=-250\mu A$	-100			V
Zero gate voltage drain current	$I_{DSS}$	$V_{DS}=-80V, V_{GS}=0V$	$T_J=25\text{ }^\circ\text{C}$		-1.0	$\mu A$
			$T_J=125\text{ }^\circ\text{C}$		-100	
Gate-body leakage current	$I_{GSS}$	$V_{DS}=0V, V_{GS}=\pm 20V$			$\pm 100$	nA
<b>On characteristics</b> <sup>④</sup>						
Gate-threshold voltage	$V_{GS(th)}$	$V_{DS}=V_{GS}, I_D=-250\mu A$	-1	-1.5	-2.5	V
Static drain-source on-state resistance	$R_{DS(on)}$	$V_{GS}=-10V, I_D=-15A$		38	45	m $\Omega$
	$R_{DS(on)}$	$V_{GS}=-4.5V, I_D=-15A$		41	55	m $\Omega$
<b>Dynamic characteristics</b> <sup>④⑤</sup>						
Input capacitance	$C_{iss}$	$V_{DS}=-20V, V_{GS}=0V, f=1MHz$		6315	12630	pF
Output capacitance	$C_{oss}$			220	440	
Reverse transfer capacitance	$C_{rss}$			50	100	
Gate resistance	$R_g$	$f=1MHz$		5.7		$\Omega$
<b>Switching characteristics</b> <sup>④⑤</sup>						
Total gate charge	$Q_g$	$V_{DS}=-20V, V_{GS}=-10V, I_D=-12A$		98	196	nC
Gate-source charge	$Q_{gs}$			16.2	32	
Gate-drain charge	$Q_{gd}$			13.8	28	
Turn-on delay time	$t_{d(on)}$	$V_{DD}=-20V, V_{GS}=-10V, R_G=3\Omega, I_D=-20A$		10		ns
Turn-on rise time	$t_r$			18		
Turn-off delay time	$t_{d(off)}$			38		
Turn-off fall time	$t_f$			24		
<b>Drain-Source Diode Characteristics</b>						
Drain-source diode forward voltage	$V_{SD}$ <sup>④</sup>	$V_{GS}=0V, I_S=-10A$			-1.2	V
Continuous drain-source diode forward current	$I_S$ <sup>①</sup>				-30	A
Pulsed drain-source diode forward current	$I_{SM}$ <sup>②</sup>				-120	A

Notes:

- $T_C=25\text{ }^\circ\text{C}$  Limited only by maximum temperature allowed.
- $P_W \leq 10\mu s$ , Duty cycle  $\leq 1\%$ .
- EAS condition:  $V_{DD}=-50V, V_{GS}=-10V, L=0.5mH, R_g=25\Omega$  Starting  $T_J=25\text{ }^\circ\text{C}$ .
- Pulse Test : Pulse Width  $\leq 300\mu s$ , duty cycle  $\leq 2\%$ .
- Guaranteed by design, not subject to production.
- The value of  $R_{\theta JA}$  is measured with the device mounted on 1 in 2 FR-4 board with 2oz. Copper, in a still air environment with  $T_a=25\text{ }^\circ\text{C}$ .

# Typical Characteristics

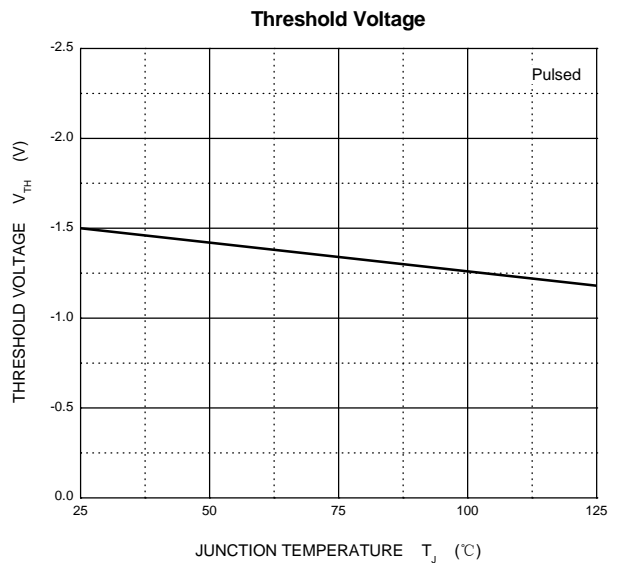
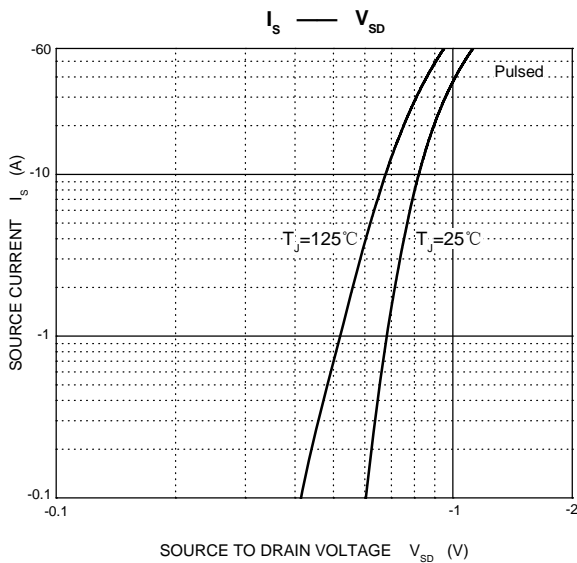
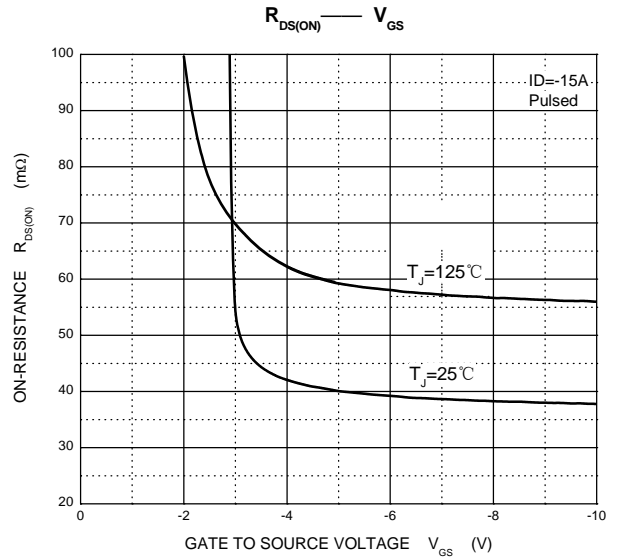
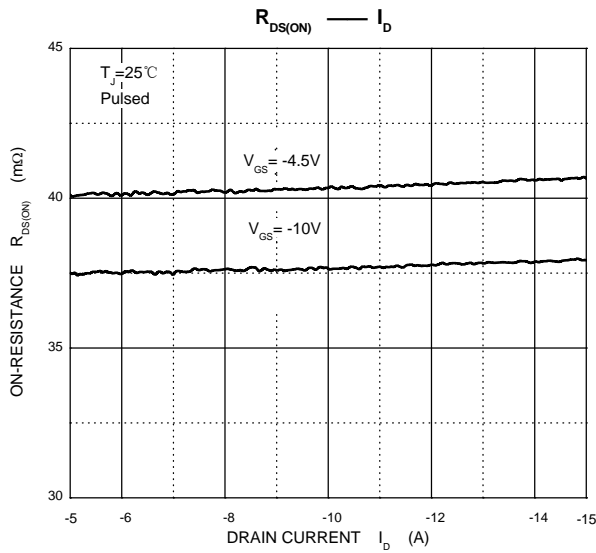
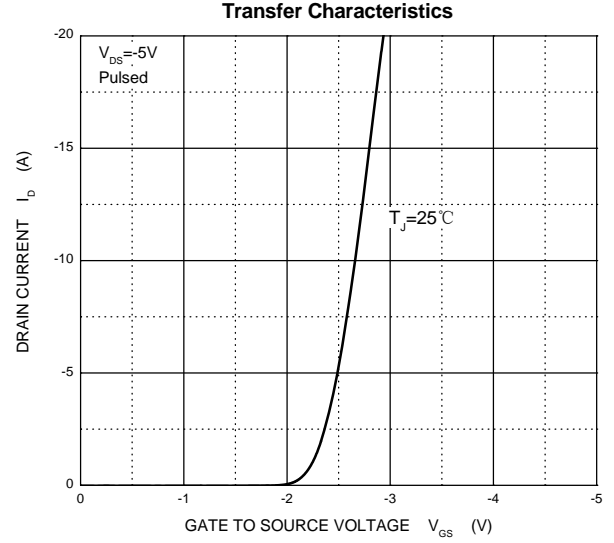
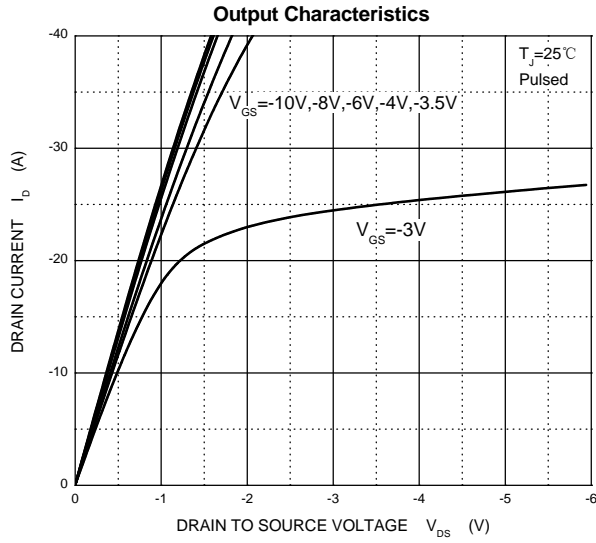

## TO-252-2L Package Outline Dimensions

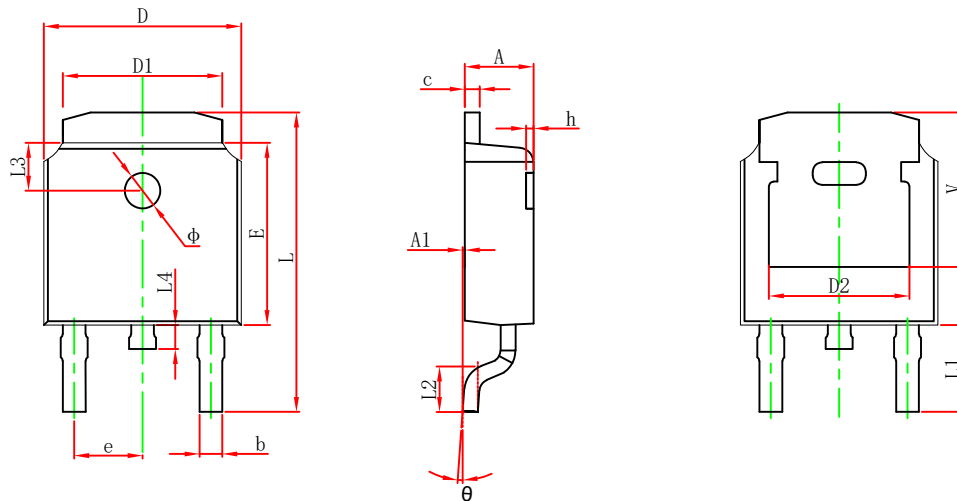

Symbol	Dimensions In Millimeters		Dimensions In Inches	
	Min.	Max.	Min.	Max.
A	2.200	2.400	0.087	0.094
A1	0.000	0.127	0.000	0.005
b	0.635	0.770	0.025	0.030
c	0.460	0.580	0.018	0.023
D	6.500	6.700	0.256	0.264
D1	5.100	5.460	0.201	0.215
D2	4.830 REF.		0.190 REF.	
E	6.000	6.200	0.236	0.244
e	2.186	2.386	0.086	0.094
L	9.712	10.312	0.382	0.406
L1	2.900 REF.		0.114 REF.	
L2	1.400	1.700	0.055	0.067
L3	1.600 REF.		0.063 REF.	
L4	0.600	1.000	0.024	0.039
$\Phi$	1.100	1.300	0.043	0.051
$\theta$	0°	8°	0°	8°
h	0.000	0.300	0.000	0.012
V	5.250 REF.		0.207 REF.	

## TO-252-2L Suggested Pad Layout

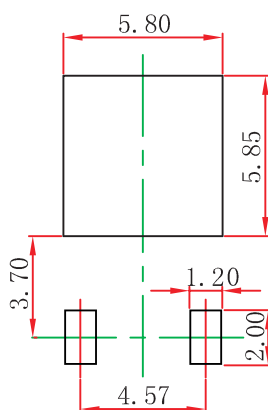

- Note:
1. Controlling dimension: in millimeters.
  2. General tolerance:  $\pm 0.05$  mm.
  3. The pad layout is for reference purposes only.

### NOTICE

JSCJ reserves the right to make modifications, enhancements, improvements, corrections or other changes without further notice to any product herein. JSCJ does not assume any liability arising out of the application or use of any product described herein.

# TO-252-2L Tape and Reel

## TO-252 Embossed Carrier Tape

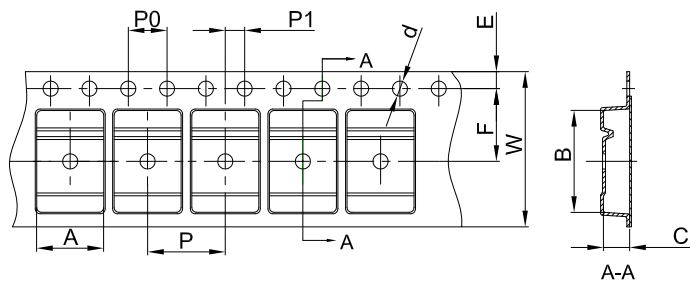

### Packaging Description:

TO-252 parts are shipped in tape. The carrier tape is made from a dissipative (carbon filled) polycarbonate resin. The cover tape is a multilayer film (Heat Activated Adhesive in nature) primarily composed of polyester film, adhesive layer, sealant, and anti-static sprayed agent. These reeled parts in standard option are shipped with 25,00 units per 13" or 33.0 cm diameter reel. The reels are clear in color and is made of polystyrene plastic (anti-static coated).

Dimensions are in millimeter										
Pkg type	A	B	C	d	E	F	P0	P	P1	W
TO-252	6.90	10.50	2.70	Ø1.55	1.75	7.50	4.00	8.00	2.00	16.00

## TO-252 Tape Leader and Trailer

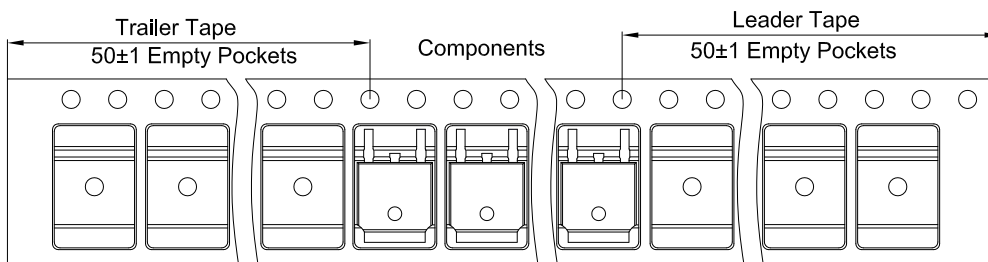

## TO-252 Reel

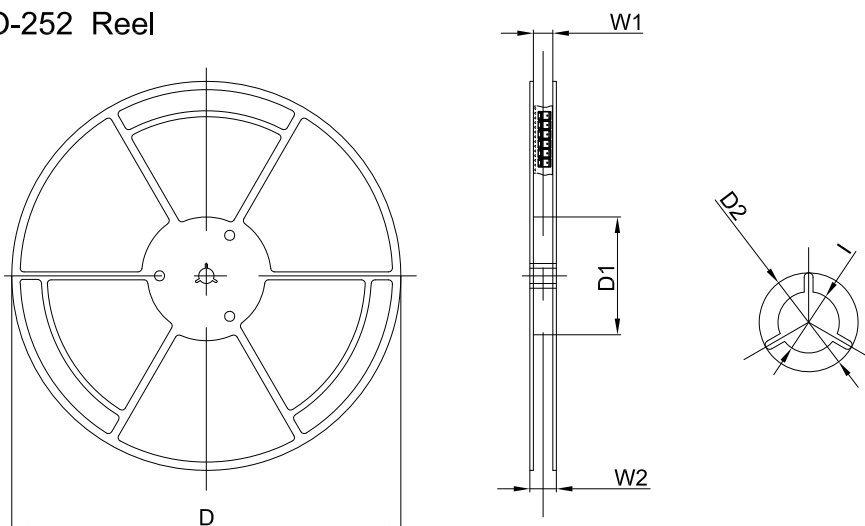

Dimensions are in millimeter						
Reel Option	D	D1	D2	W1	W2	I
13" Dia	330.00	100.00	Ø21.00	16.40	21.00	Ø13.00

REEL	Reel Size	Box	Box Size(mm)	Carton	Carton Size(mm)	G.W.(kg)
2,500 pcs	13inch	2,500 pcs	340×336×29	25,000 pcs	353×346×365	