

**ESD Notch Filters**  
For wireless audio equipment



# AVRF series



## FEATURES

- This is an electronic component that achieves both ESD protection and noise protection.
- TDMA noises generated by radio communication can be suppressed.
- The high-attenuation characteristics of the Bluetooth band and the WiFi band are highly effective in preventing degradation of the reception sensitivity of radio equipment.
- It is ideal for audio equipment with low sound distortion and high sound quality.

## APPLICATION

- ESD protection such as sound lines
- Sound lines for devices such as smartphones, tablets, headsets, hearing aids, smart speakers and wearable equipments (earphones, microphones, and speakers)

## CIRCUIT EXAMPLE

### Microphone line

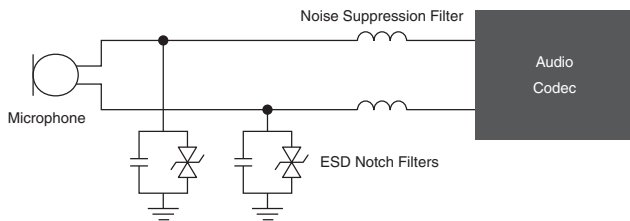

### Speaker or Receiver line

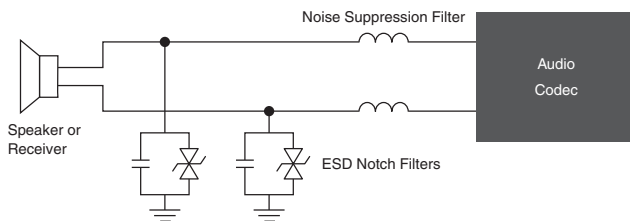

## EQUIVALENT CIRCUIT

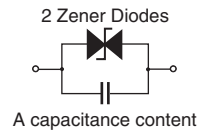

## INTERNAL CONSTRUCTION

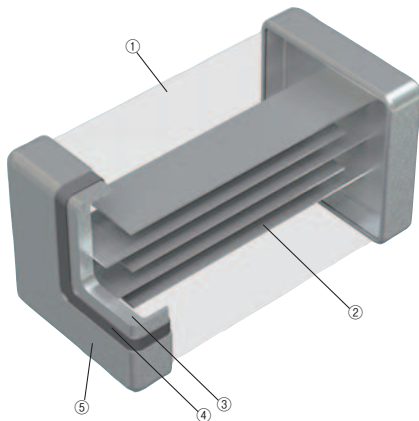

No.	Name
(1)	Semiconductor ceramics
(2)	Internal electrode(Pd)
(3)	Ag
(4)	Terminal electrode Ni
(5)	Sn

# AVRF series

## PART NUMBER CONSTRUCTION

AVRF	10	1U	6R8	K	T	242						
Series name	L x W dimensions (mm)		Rated voltage (V)		Capacitance (pF)		Capacitance tolerance (%)		Packaging style		Insertion loss frequency (MHz)	
	06	0.6×0.3	0V	3.5	6R8	6.8	K	±10	T	Taping	242=24×10 <sup>2</sup>	
	10	1.0×0.5	0W	5.5	8R2	8.2	L	±15	B	Bulk	102	1000
			0X	7	100	100=10×10 <sup>0</sup>	M	±20			212	2100
			1P	12	160	16					242	2400
			1U	28	600	60					272	2700
					650	65						

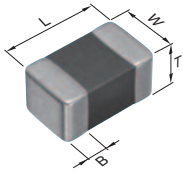

Shape symbol (JIS)	L	W	T	B
0603	0.6±0.03	0.30±0.03	0.30±0.03	0.1min.
1005	1.00±0.05	0.50±0.05	0.50±0.05	0.1min.

## OPERATING TEMPERATURE RANGE, PACKAGE QUANTITY, PRODUCT WEIGHT

Type	Temperature range		Package quantity (pieces/reel)	Individual weight (mg)
	Operating temperature* (°C)	Storage temperature** (°C)		
AVRF06	-40 to +85	-40 to +85	15,000	0.2
AVRF10	-40 to +85	-40 to +85	10,000	1.2

\* Operating temperature range includes self-temperature rise.

\*\* The storage temperature range is for after the assembly.

## TERMINOLOGY

Item	Unit	Description
Insertion loss	IL (dB)	Power loss when measured by shunt-through connection of a product in a 50Ω measurement system
Rated voltage	V <sub>dc</sub> (V)	DC voltage that is continuously applied between product terminals Terminal products leakage current-value: 50μA max. (Rated voltage range)
Capacitance	C (pF)	Oscillator frequency 1kHz or 1MHz, capacitance between product terminal in oscillator voltage 1V <sub>rms</sub>
Breakdown voltage	V <sub>br</sub> (V)	Product terminal voltage when DC1mA was flowed

# AVRF series

## PRODUCT CHARACTERISTICS LIST

Item	Insertion loss	Rated voltage	Breakdown voltage	Capacitance	ESD voltage amount	Application
	IL (dB)	Vdc (V)	I=1mA Vbr (V)	f=1MHz, osc=1Vrms C (pF)	IEC61000-4-2 150pF/330Ω	
<a href="#">AVRF060V600MT102</a>	20min.(1GHz)	3.5	6.8typ.	60 (48 to 72)	8kV	Cellular
<a href="#">AVRF060W650MT102</a>	20min.(1GHz)	5.5	8typ.	65 (52 to 78)	8kV	Cellular
<a href="#">AVRF061P160MT212</a>	20min.(2.1GHz)	12	20typ.	16 (12.8 to 19.2)	8kV	Cellular/WiFi/Bluetooth
<a href="#">AVRF060X100LT242</a>	20min.(2.4GHz)	7	12.8typ.	10 (8.5 to 11.5)	8kV	WiFi/Bluetooth
<a href="#">AVRF060X8R2LT272</a>	20min.(2.7GHz)	7	12.8typ.	8.2 (6.97 to 9.43)	8kV	WiFi/Bluetooth
<a href="#">AVRF101U6R8KT242</a>	20min.(2.4GHz)	28	39typ.	6.8 (6.12 to 7.48)	8kV	WiFi/Bluetooth

## ELECTRICAL CHARACTERISTICS

### INSERTION LOSS VS. FREQUENCY CHARACTERISTICS

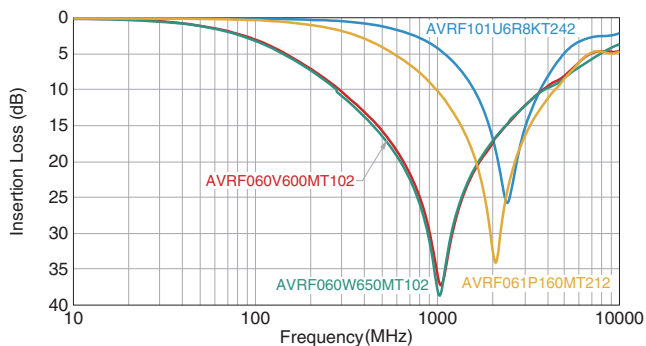

### INSERTION LOSS VS. FREQUENCY CHARACTERISTICS

Application: WiFi / Bluetooth

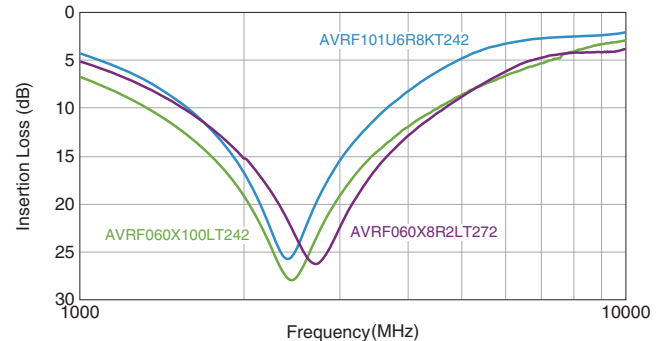

### CURRENT VS. VOLTAGE CHARACTERISTICS

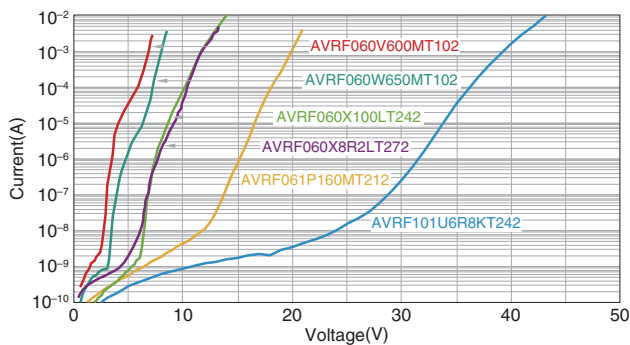

# AVRF series

## DISCHARGE VOLTAGE WAVEFORM (EXAMPLE)

### DISCHARGE WAVEFORM WITHOUT ESD NOTCH FILTERS AND WITH ESD NOTCH FILTERS INSTALLED

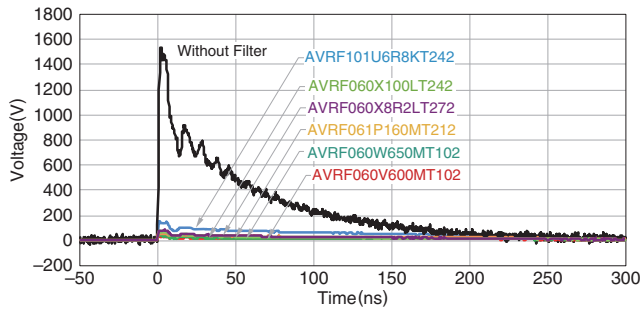

### Test conditions

150pF/330Ω (IEC61000-4-2)

Contact discharge, Charged voltage 8kV

### TEST CIRCUIT DIAGRAM

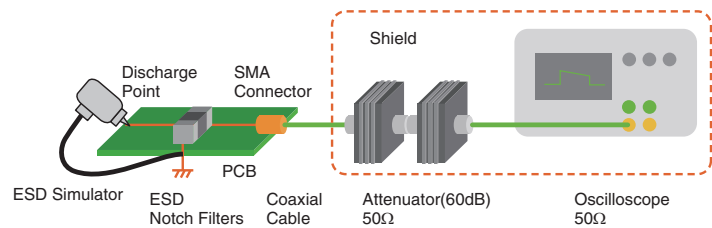
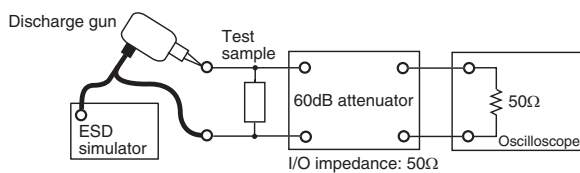

# AVRF series

## Attention on a circuit board design

### Board design

When attached to products, amount of silver used (fillet size) has direct impact on products after mounting. Thus, sufficient consideration is necessary.

### Set of land dimensions

(1) As the stress rises in the products owing to the increase in silver, breakage and cracks will occur. Cause including crack, as caution on board land design, configure the shape and dimensions so that the amount of silver is appropriate. If you installed 2 or more parts in the Common Land, separated by a solder resist and special land of each component.

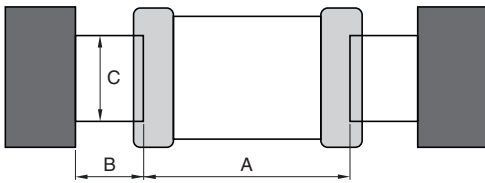

Dimensions shape	Symbol		
	A	B	C
0603	0.25 to 0.35	0.20 to 0.30	0.25 to 0.35
1005	0.30 to 0.50	0.35 to 0.45	0.40 to 0.60

(2) When peak levels panning-at soldering is excessive, by solder contraction stress, mechanical-thermal stress causes a Yasuku chip crack. In addition, when the peak level is underestimated, terminal electrode fixed strength is insufficient. This causes chip dropouts and may affect circuit reliability. Representative example of the panning of peak levels is shown in the following.

### Recommended silver dose

Solder volume overload

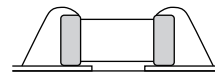

Solder stress is increased, and it is easy for a crack to form.

Decent solder volume

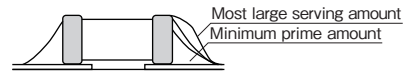

Solder volume deficit

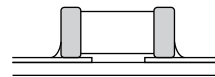

Fixed strength is weak, and there is connection problem and risk of loss.

### Case and suggested protocol want to avoid

Example	Cases to avoid	Improvement example (land division)
Lead wire and land of part discrete doubles up		
Arrangements in the vicinity		
Arrangements of chip component's companion		

# AVRF series

## Attention on a circuit board design

### Arrangements of components

(1) I was based on camber of substrate and suggested protocol of products arrangement, as stress does not join to the utmost is shown in following.

	Substrate for flexural stress Adverse events	Substrate for flexural stress Good example
Direction of surface solder	<p>Solder the mountain fold as a top.</p>	<p>Solder the mountain fold as a bottom. [Please review the italicized portion, as I am unsure what you mean to convey here.]</p>
Chip arrangements (direction)	<p>Mounted vertically to the perforation and slit.</p>	<p>Mounted horizontally to the perforation and slit.</p>
Distance from perforation and slit portion	<p>(<math>L1 &lt; L2</math>)</p> <p>Close location is disadvantageous of perforation and slit.</p>	<p>(<math>L1 &lt; L2</math>)</p> <p>It is an advantage so distant location away places the perforation and slit.</p>

(2) In payment near by board, depending on mount position of products, as mechanical stress varies, please refer to the following diagram.

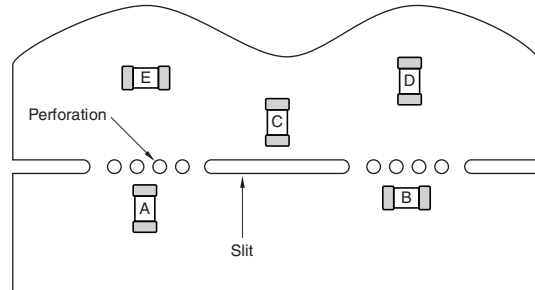

The order of  $A > B = C > D > E$  eases the stress.

# AVRF series

## Local precautions

### Application to board

#### Mounting head pressure

Under suction nozzle if dead point too, during implementation, excessive force joins of products low, as cause causes of crack, please use with reference to something about following.

- 1) Being set to top surface of substrate so that under suction nozzle as for dead center, substrate does not bend back, and adjust, please.
- 2) Nozzle pressure at implementation is 1 to 3N in static load, please.
- 3) Substrate fixes up back surface of substrate with support pin in impact of suction nozzle to wely deflection to the utmost, and substrate hold deflection, please. A representative example is shown in the following.

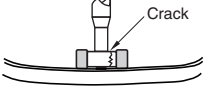
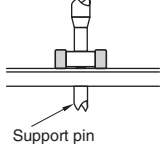
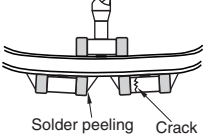
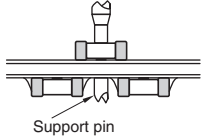
	Cases to avoid	Recommended case
Single-sided mounting		
Double-sided mounting		

Mechanical shock that, if positioning your nail to wear, ragged edge of positionings, participates in products are locally, and products, as there is possibility of crack generated, cut the closed positioning, and maintenance and inspection, and, exchange of manage dimensions and position nail periodically, please.

### Soldering

Significant impact is possible on the performance of products, flux checks something about follow, please use.

- (1) Flux uses one with 0.1wt % (Cl conversion) or less halide substance contains amounts, please. In addition, do not do this with strongly acidic objects.
- Flux during is soldered (2) Products is applied the smallest amount necessary, please.
- (3) If Used soluble flux, perform thorough wash particularly, please.

Reflow temperature profile

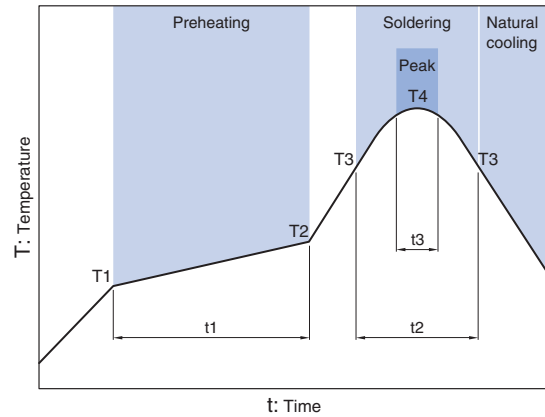

Item	Specification	
	for eutectic mixture solder	Use of lead-free solder
Preheating temperature	160 to 180°C	150 to 180°C
Solder melting temperature	200°C	230°C
Maximum temperature	240°C max.	260°C max.
Preheating time	100s max.	120s max.
Time to reach higher than the solder melting temperature	30s max.	40s max.
number of possible reflow cycles	2 max.	2 max.

### Soldering iron

The tip temperature and also by (1) types of soldering irons, the size of the substrate, and the geometry of the land pattern. Being earlier, but when as there is possibility that crack occurs in the heat under-son impaction, point soldering iron temperature is high, please do solder work within the following conditions.

Temperature of iron tips (°C)	Wattage (W)	Pallet point shape (mm)	Soldering time (Second)	Frequency
350max.	30max.	ø3.0max.	5 max.	Within each terminal once (Within total of twice)

Direct iron tip is in contact with the (2) products body, and the strain owing to thermal shock in particular grows even if a crack is generated. Therefore, please do not touch it directly to the terminal electrodes.

# AVRF series

## Attention after implementation

### Cleaning

- (1) If cleaning liquid is inappropriate, residues and other foreign body of fluxes builds up on products, and can degrade the performance of products (particularly the insulation resistance).
- (2) Wash conditions may compromise performance of products if they are improper (wash due, wash excess).

#### 2-1) For wash due

- (a) By substance of a system in flux residue halide, metal including terminal electrodes may experience corrosion.
- (b) Substance of a system in flux residue halide builds up on products, and reduces the insulation resistance.
- (c) Soluble flux makes comparisons of colophony series flux, and there is event with trends of significant (1) and(2).

#### 2-2) For excess wash

- (1) Owing to lavage, products deteriorates, and reduces performance of products.
- (2) In ultrasonography, when output is passed, substrate resonates size, and crack occurs in body and sprang of products in vibration of substrate. Since this may reduce the strength of the terminal electrode, please note the following conditions. [Please review the italicized portion, as I am unsure what you mean to convey here.]
- Ultrasound output
  - Ultrasonic frequency
  - Ultrasound cleaning time

2-3) Concentration including halogen that when cleaning liquid to pollution, when you released is higher, and may cause similar of results into wash due.

### Substrate handling after component mounting

- (1) When substrate is divided, a flexible so that show in following diagram to substrate, and is given by stress including twist, as there is possibility that crack occurs of products, please check that stress is within acceptable limits.

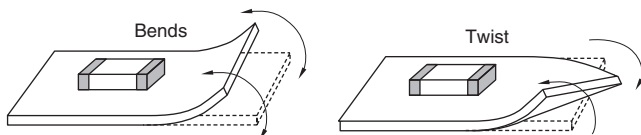

- (2) During each substrate operational check, push pressure with contact failure of check pin of boards checkers of check pin may be toned up to be prevented. As substrate is bent under loading, products is broken owing to stress. There is also the possibility that solder on the terminal electrode will peel off. Follow the diagram for reference, and check that the substrate bends, please.

Item	Cases to avoid	Recommended case
Substrate sags		

### Single-part component handling

To drop impact, as there is possibility that breakage and crack is entered, do not products that(1) products falls.

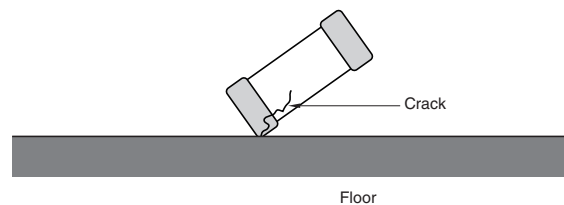

- (2) At stacking storage after implementation and treatment of substrate, corner of boards is regarded as products. Please be careful, as there is the possibility that breakage and cracks will occur on impact.

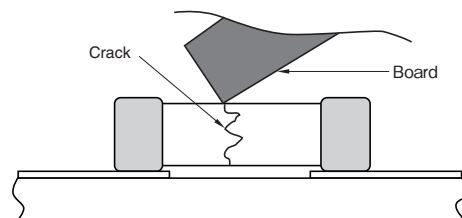



# AVRF series

## PACKAGING STYLE

### REEL DIMENSIONS

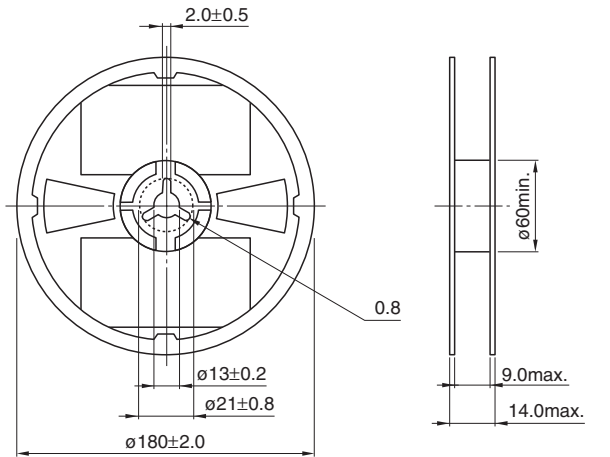

Dimensions in mm

## PACKAGE QUANTITY / INDIVIDUAL WEIGHT

Type	Package quantity (pieces/reel)	Individual weight (mg)
AVRF06	15,000	0.2
AVRF10	10,000	1.2

### TAPE DIMENSIONS

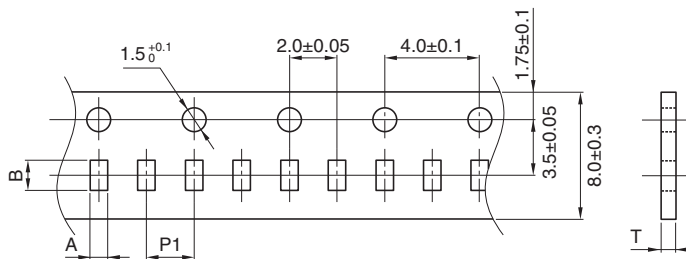

Dimensions in mm

Type	A	B	P1	T
0603	0.38±0.05	0.68±0.05	2.0±0.05	0.45max.
1005	0.65+0.05/-0.1	1.15+0.05/-0.1	2.0±0.05	0.65max.

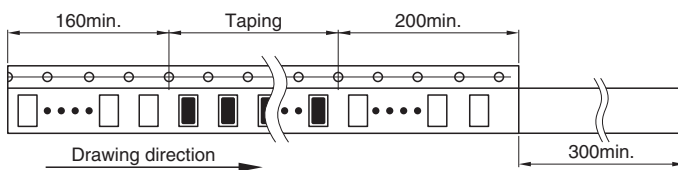

Dimensions in mm

## REMINDERS FOR USING THESE PRODUCTS

Before using these products, be sure to request the delivery specifications.

### SAFETY REMINDERS

Please pay sufficient attention to the warnings for safe designing when using this products.

#### REMINDERS

- Please pay careful attention to the precautions and follow safe designing practices when using these products.
- Please observe the following precautions in order to avoid problems with products such as characteristic degradation and element destruction
  - Please store these products in an environment with a temperature of 5 to 40°C and humidity level of 20 to 70%RH, and use them within six months.
  - Poor storage conditions may lead to the deterioration of the solderability of the edge electrodes, so please be careful to avoid contact with humidity, dew condensation, dust, toxic gas (hydrogen, hydrogen sulfide, sulfurous acid, chlorine, ammonia, etc.), direct sunlight, and so on.
  - Please do not use products that have been dropped or detached when mounting.
  - Please solder with the reflow soldering method, and not the flow (dip) soldering method.
- Please observe the following precautions to avoid problems with products such as characteristic degradation and element destruction, which ultimately lead to the generation of heat and smoke with the elements.
  - Do not use in locations where the temperatures exceed the operating temperature range such as under direct sunlight or near sources of heat.
  - Do not use in locations where there are high levels of humidity such as under direct exposure to weather and areas where steam is released.
  - Do not use in locations such as dusty areas, high-saline environments, places where the atmosphere is contaminated with corrosive gas, etc.
  - Avoid powerful vibrations, impact (such as by dropping), pressure, etc. that may lead to splitting in the products.
  - Do not use with a voltage that exceeds the rated voltage.**
  - When resin coating (including modular) a product, do not use a resin that will cause deterioration of the product. Be sure never to use resin that generates hydrogen as palladium is used for the inner electrode.
  - Avoid attachment near combustible materials.
- Please contact our sales offices when considering the use of the products listed on this catalog for applications, whose performance and/or quality require a more stringent level of safety or reliability, or whose failure, malfunction or trouble could cause serious damage to society, person or property ('specific uses' such as automobiles, airplanes, medical instruments, nuclear devices, etc.) as well as when considering the use for applications that exceed the range and conditions of this catalog.

Please also contact us when using these products for automotive applications.
- As range of catalog, conditions are transcended, or for damage that generated by was used in application specific, etc, accept no the responsibility, wish.
- Please take appropriate measures such as acquiring protective circuits and devices that meet the uses, applications, and conditions of the instruments and keeping backup circuits.