



MD7601 Series is a high voltage (up to 40V) low power low dropout voltage regulator (LDO) manufactured in CMOS processes. It can deliver up to 1A of current while consuming only 12uA of quiescent current. It consists of a reference voltage generator, an error amplifier, a current foldback circuit, and a phase compensation circuit plus a driver transistor.

**FEATURES**

- Ultra-low Quiescent Current: 12uA
- Maximum Input Voltage: 40V
- Output Voltage Highly Accurate:  $\pm 2\%$
- Maximum Output Current: 1A
- Dropout Voltage: 10mV@ $I_{OUT}=10mA$
- Temperature Stability:  $\pm 50ppm/^{\circ}C$
- Protections Circuits: Current Limiter, Foldback, Thermal shutdown
- Output Capacitor: Low ESR Ceramic Capacitor Compatible

- Smart wearer
- Long-life battery-powered devices
- Portable mobile devices, such as mobile phones, cameras, and so on
- Wireless communication equipment

**APPLICATIONS**

**Product Selections**

Type	Output Voltage (note 1*)	Current Limit	Accuracy	Package (note 2*)	MARKING (note 3*)
MD7601A30	3.0V	1.8A	$\pm 2\%$	TO-252	7601A30
MD7601A33	3.3V	1.8A	$\pm 2\%$	TO-252	7601A33
MD7601A36	3.6V	1.8A	$\pm 2\%$	TO-252	7601A36
MD7601A40	4.0V	1.8A	$\pm 2\%$	TO-252	7601A40
MD7601A50	5.0V	1.8A	$\pm 2\%$	TO-252	7601A50
MD7601A12	12.5V	1.8A	$\pm 2\%$	TO-252	7601A12
MD7601B30	3.0V	1.8A	$\pm 2\%$	SOT-223	7601B30
MD7601B33	3.3V	1.8A	$\pm 2\%$	SOT-223	7601B33
MD7601B36	3.6V	1.8A	$\pm 2\%$	SOT-223	7601B36
MD7601B40	4.0V	1.8A	$\pm 2\%$	SOT-223	7601B40
MD7601B50	5.0V	1.8A	$\pm 2\%$	SOT-223	7601B50
MD7601B57	5.7V	1.8A	$\pm 2\%$	SOT-223	7601B57
MD7601B12	12.0V	1.8A	$\pm 2\%$	SOT-223	7601B12
MD7601C30	3.0V	1.8A	$\pm 2\%$	SOT-223	7601C30
MD7601C33	3.3V	1.8A	$\pm 2\%$	SOT-223	7601C33
MD7601C36	3.6V	1.8A	$\pm 2\%$	SOT-223	7601C36

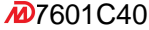
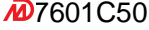
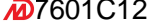
MD7601C40	4.0V	1.8A	±2%	SOT-223	
MD7601C50	5.0V	1.8A	±2%	SOT-223	
MD7601C12	12.0V	1.8A	±2%	SOT-223	

**Notes:**

1\* Customer can request to customize the output voltage ranged from 1.2V to 15V if desired voltage is not found in the selections.

2\* Customer can request customization of package choice.

3\* Please pay attention to the MARKING of the product package type.

**■ PIN CONFIGURATION (TOP VIEW)**

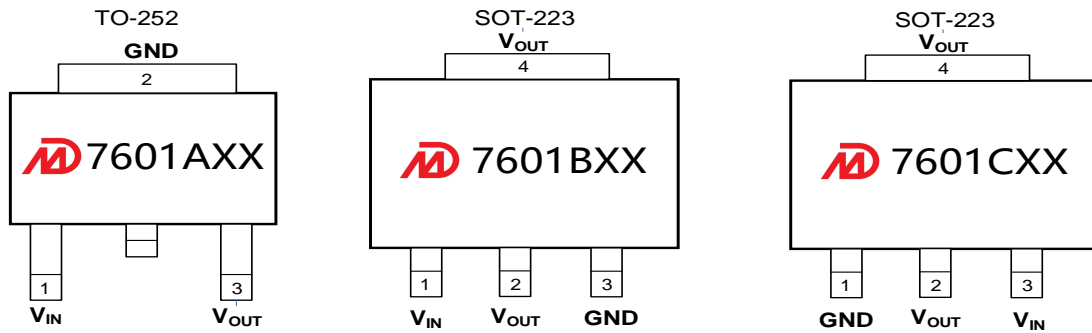

**■ Absolute Maximum Ratings (Unless otherwise indicated:  $T_a=25^\circ\text{C}$ )**

PARAMETER	SYMBOL	RATINGS	UNITS
Input Voltage	$V_{IN}$	-0.3 ~ 45	V
Output Voltage	$V_{OUT}$	$V_{SS}-0.3 \sim V_{IN}+0.3V$	
Power Dissipation	$P_D$	TO 252 1800 SOT 223 1500	mW
Operating Ambient Temperature	$T_{opr}$	-40 ~ +85	$^\circ\text{C}$
Storage Temperature	$T_{stg}$	-40 ~ +125	
ESD Protection	ESD HBM	2000	V

**Note:** Stresses above those listed under "Absolute Maximum Ratings" may cause permanent damage to the device.

## ■ ELECTRICAL CHARACTERISTICS

MD7601 Series (Unless otherwise indicated:  $T_a=25^{\circ}\text{C}$ )

PARAMETER	SYMBOL	CONDITIONS	MIN.	TYP.	MAX.	UNIT	
Output Voltage <sup>*1</sup>	$V_{OUT(S)}$	$V_{IN}=V_{OUT(S)}+2V, I_{OUT}=10\text{mA}$	$V_{OUT(S)} \times 0.98$	$V_{OUT(S)}$	$V_{OUT(S)} \times 1.02$	V	
Dropout Voltage <sup>*2</sup>	$V_{DROP}$	$I_{OUT}=1\text{mA}$		4	8	mV	
		$I_{OUT}=1\text{A}$		1000	1500		
Line Regulation	$\frac{\Delta V_{OUT}}{\Delta V_{IN} \cdot V_{OUT(S)}}$	$V_{OUT(S)}+2V \leq V_{IN} \leq 40V$ $I_{OUT}=1\text{mA}$		0.01	0.02	%/V	
Load Regulation	$\Delta V_{OUT2}$	$V_{IN}=V_{OUT(S)}+2V$ $1\text{mA} \leq I_{OUT} \leq 300\text{mA}$	$V_{OUT(S)} \leq 10V$		20	80	mV
			$V_{OUT(S)} > 10V$		85	150	
Temperature Stability	$\frac{\Delta V_{OUT}}{\Delta T_a \cdot V_{OUT(S)}}$	$V_{IN}=V_{OUT(S)}+2V, I_{OUT}=10\text{mA}$ $-40^{\circ}\text{C} \leq T_a \leq 85^{\circ}\text{C}$		$\pm 50$		ppm/ $^{\circ}\text{C}$	
GND Current	$I_{GND}$	no load	$V_{OUT(S)} \leq 10V$		10	30	uA
			$V_{OUT(S)} > 10V$		12	30	
		$I_{OUT}=100\text{mA}$		460			
Input Voltage	$V_{IN}$	---	2.2		40	V	
Maximum Output Current	$I_{OUTMAX}$		1			A	
Current Limit <sup>*3</sup>	$I_{LIM}$	$V_{IN}=V_{OUT(S)}+2V,$ $V_{OUT}=0.95 \times V_{OUT(S)}$		1.8			
Short Circuit Current <sup>*4</sup>	$I_{SHORT}$	$V_{IN}=V_{OUT(S)}+2V$ $V_{OUT}=0V$	$V_{OUT(S)} \leq 10V$		50	mA	
			$V_{OUT(S)} > 10V$		75		
Power Supply Rejection Ratio	PSRR	$f=10\text{Hz}, V_{OUT(S)}=3.6V$		84		dB	
		$f=100\text{Hz}, V_{OUT(S)}=3.6V$		80			
		$f=1\text{kHz}, V_{OUT(S)}=3.6V$		58			
Over Temperature Protection	OTP	$I_{OUT}=1\text{mA}$		180		$^{\circ}\text{C}$	

Notes:

1.  $V_{OUT(S)}$ : Output voltage when  $V_{IN}=V_{OUT}+2V, I_{OUT}=1\text{mA}$ .
2.  $V_{DROP}=V_{IN1} - (V_{OUT(S)} \times 0.98)$  where  $V_{IN1}$  is the input voltage when  $V_{OUT} = V_{OUT(S)} \times 0.98$ .
3.  $I_{LIM}$ : Output current when  $V_{IN}=V_{OUT(S)}+2V$  and  $V_{OUT} = 0.95 \times V_{OUT(S)}$ .
4.  $V_{OUT}$  pin should be shorted to GND pin, and the impedance between them is less than 0.1 ohm.

## ■ TYPICAL APPLICATIONS

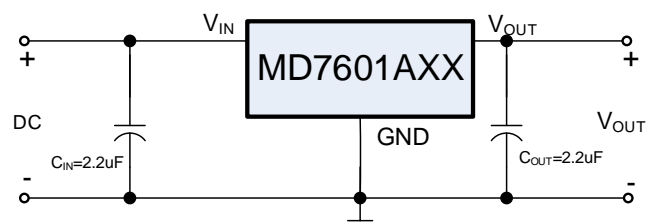

### ■ Notes on Use

Input Capacitor ( $C_{IN}$ ): 2.2 $\mu\text{F}$  above

Output Capacitor ( $C_{OUT}$ ): 2.2 $\mu\text{F}$  above

## ■ TYPICAL PERFORMANCE CHARACTERISTICS(CONTINUED)

Test Conditions:  $V_{IN}=V_{OUT}+2.0V$ ,  $C_{IN}=2.2\mu F$ ,  $C_{OUT}=2.2\mu F$ , unless otherwise indicated.

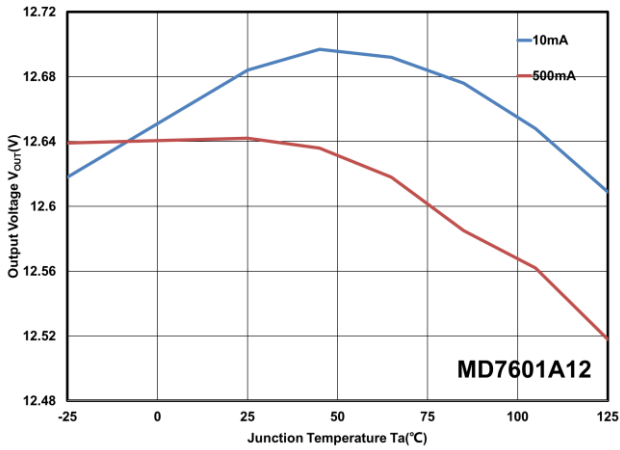

$V_{OUT}$  vs Temperature at  $V_{OUT}=12V$

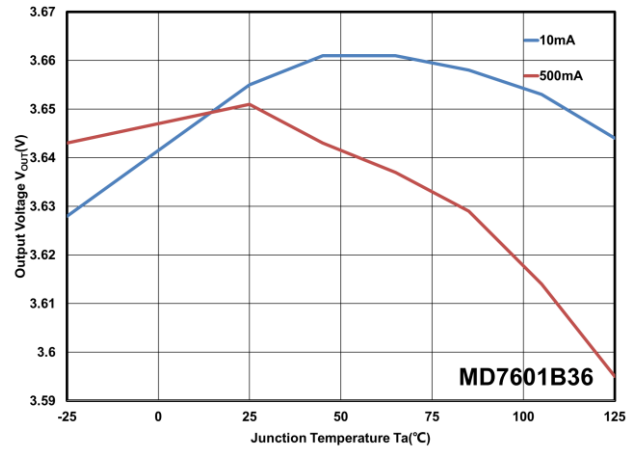

$V_{OUT}$  vs Temperature at  $V_{OUT}=3.6V$

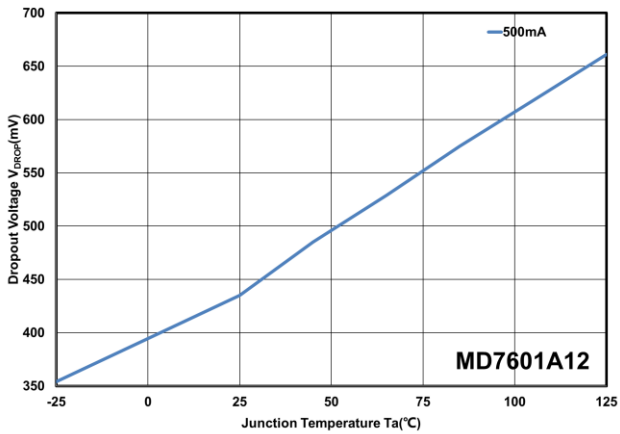

$V_{DROP}$  vs Temperature at  $V_{OUT}=12V$

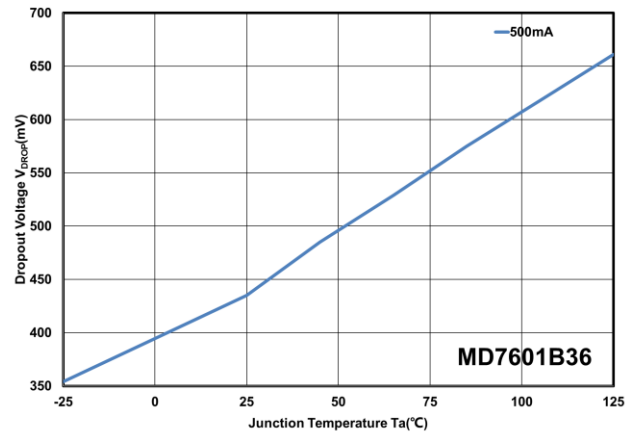

$V_{DROP}$  vs Temperature at  $V_{OUT}=3.6V$

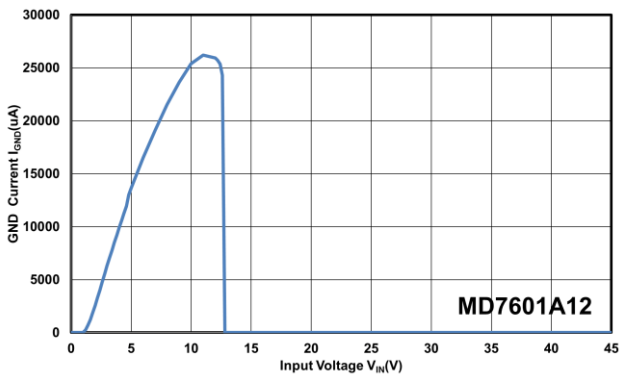

GND Current vs Input Voltage at  $V_{OUT}=12V$

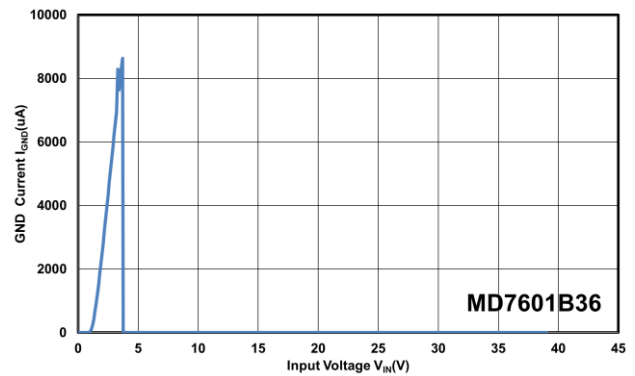

GND Current vs Input Voltage at  $V_{OUT}=3.6V$

## ■ TYPICAL PERFORMANCE CHARACTERISTICS(CONTINUED)

Test Conditions:  $V_{IN}=V_{OUT}+2.0V$ ,  $C_{IN}=2.2\mu F$ ,  $C_{OUT}=2.2\mu F$ , unless otherwise indicated.

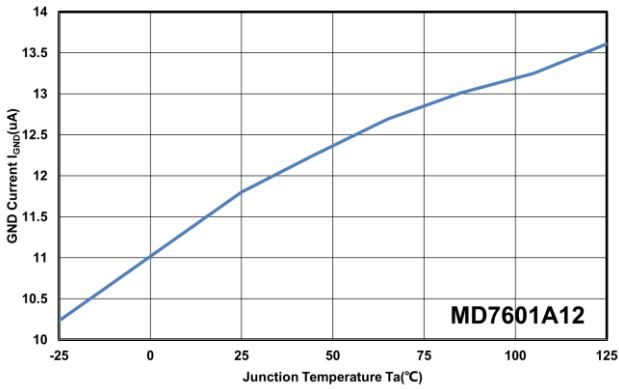

GND Current vs Temperature at  $V_{OUT}=12V$

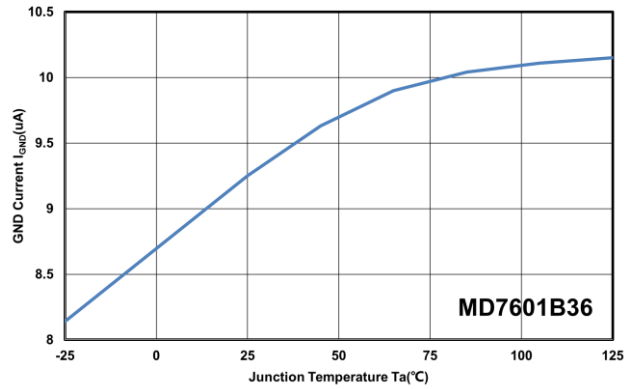

GND Current vs Temperature at  $V_{OUT}=3.6V$

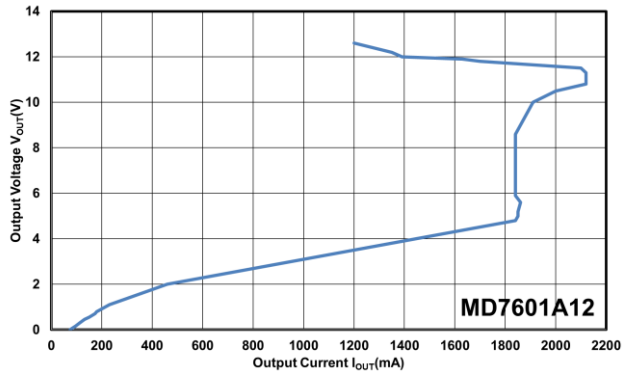

Output Current Fold-back at  $V_{OUT}=12V$

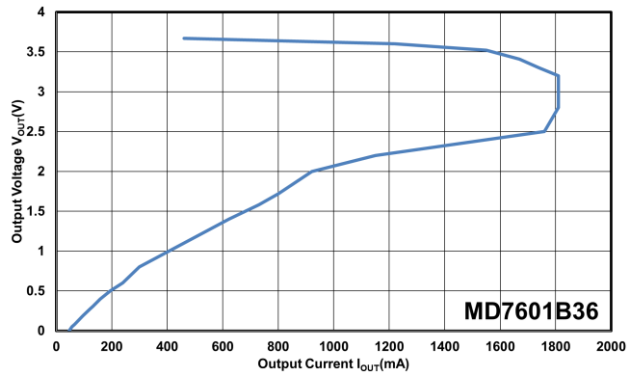

Output Current Fold-back at  $V_{OUT}=3.6V$

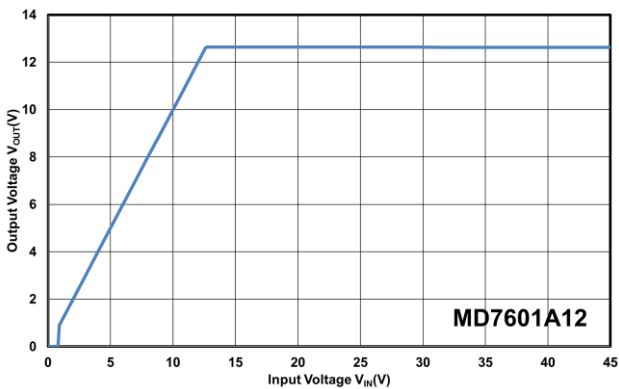

Output Voltage vs Input Voltage at  $V_{OUT}=12V$

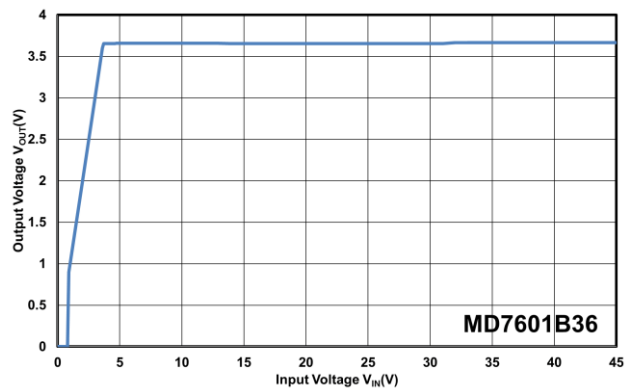

Output Voltage vs Input Voltage at  $V_{OUT}=3.6V$

## ■ TYPICAL PERFORMANCE CHARACTERISTICS(CONTINUED)

Test Conditions:  $V_{IN}=V_{OUT}+2.0V$ ,  $C_{IN}=2.2\mu F$ ,  $C_{OUT}=2.2\mu F$ , unless otherwise indicated.

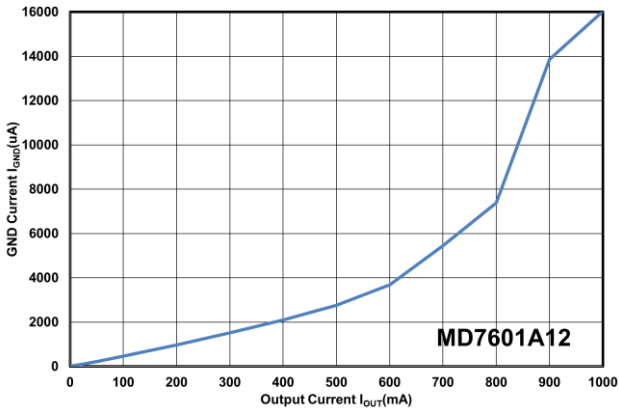

GND Current vs Output Current at  $V_{OUT}=12V$

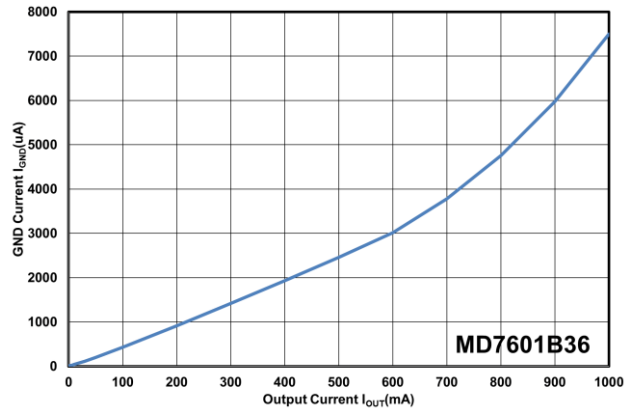

GND Current vs Output Current at  $V_{OUT}=3.6V$

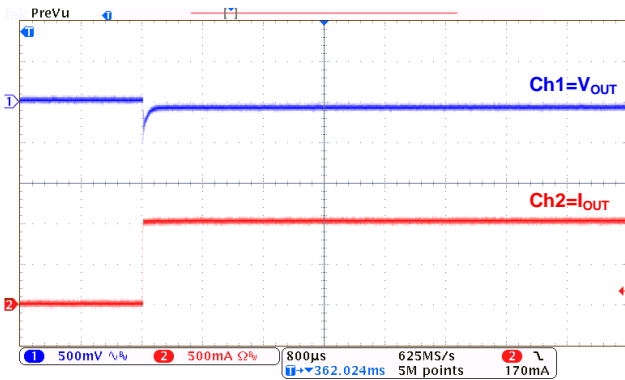

Load Transient at  $V_{OUT}=12V$   
7601A12( $I_{OUT}=0mA\sim 1A$ )

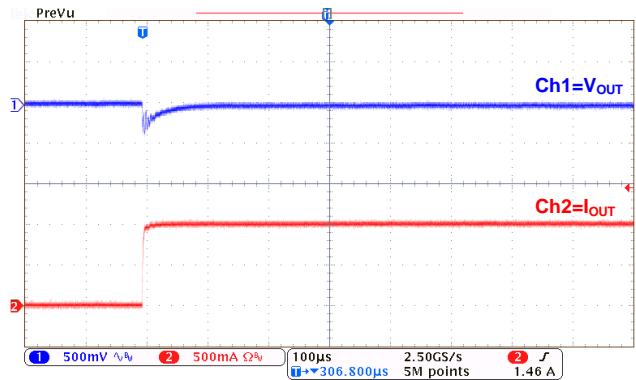

Load Transient at  $V_{OUT}=3.6V$   
7601B36( $I_{OUT}=0mA\sim 1A$ )

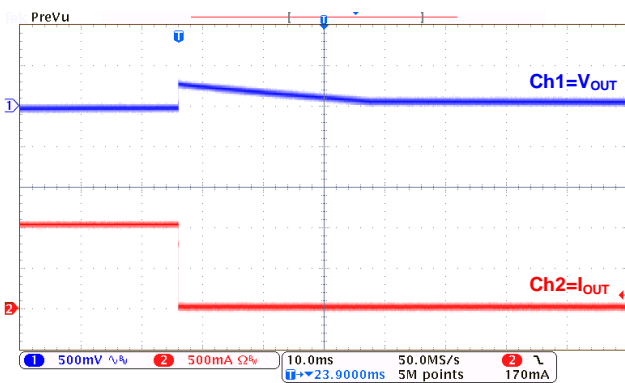

Load Transient at  $V_{OUT}=12V$   
7601A12( $I_{OUT}=1A\sim 0mA$ )

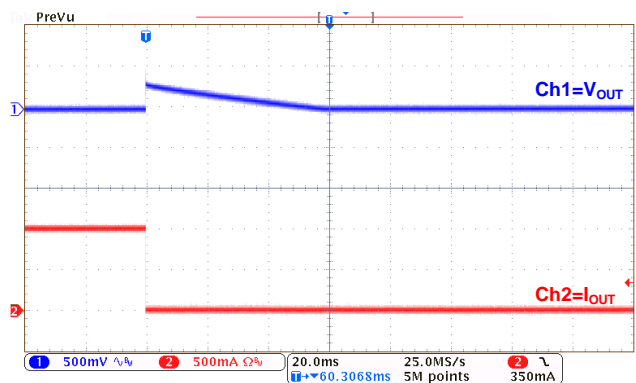

Load Transient at  $V_{OUT}=3.6V$   
7601B36( $I_{OUT}=1A\sim 0mA$ )

## ■ TYPICAL PERFORMANCE CHARACTERISTICS(CONTINUED)

Test Conditions:  $V_{IN}=V_{OUT}+2.0V$ ,  $C_{IN}=2.2\mu F$ ,  $C_{OUT}=2.2\mu F$ , unless otherwise indicated.

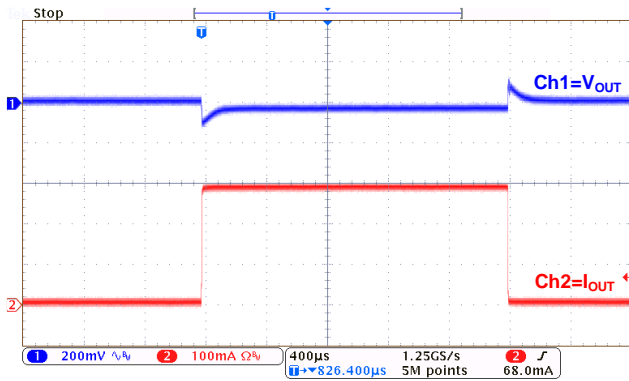

Load Transient at  $V_{OUT}=12V$   
7601A12( $I_{OUT}=1mA\sim 300mA\sim 1mA$ )

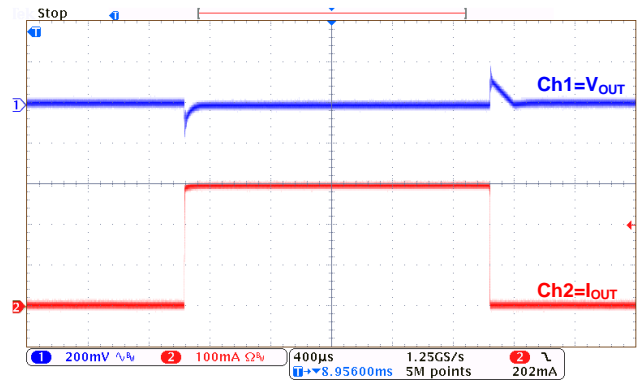

Load Transient at  $V_{OUT}=3.6V$   
7601B36( $I_{OUT}=1mA\sim 300mA\sim 1mA$ )

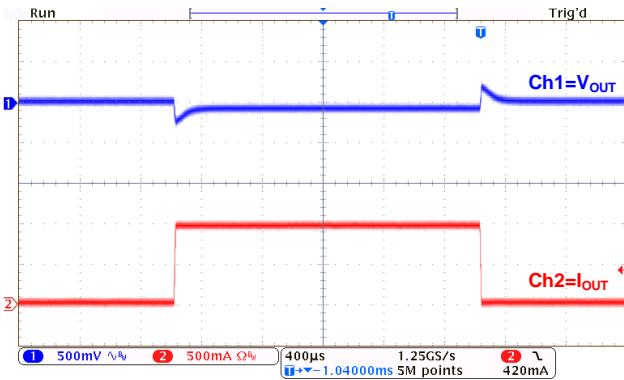

Load Transient at  $V_{OUT}=12V$   
7601A12( $I_{OUT}=1mA\sim 1A\sim 1mA$ )

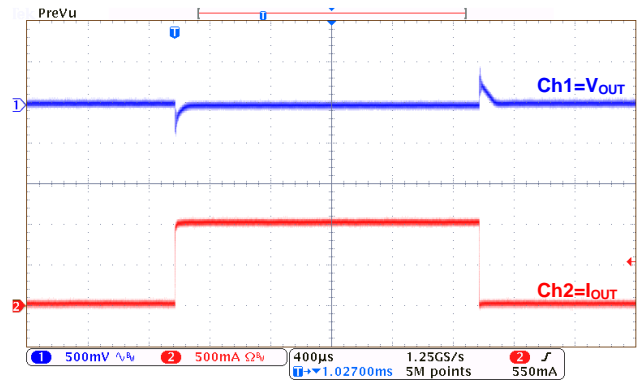

Load Transient at  $V_{OUT}=3.6V$   
7601B36( $I_{OUT}=1mA\sim 1A\sim 1mA$ )

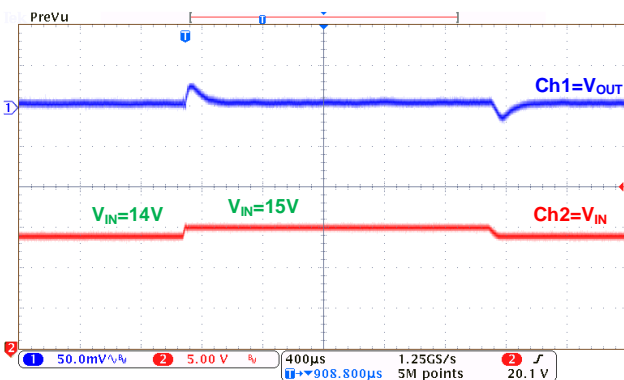

Line Transient at  $V_{OUT}=12V$   
7601A12( $I_{OUT}=1mA$ )

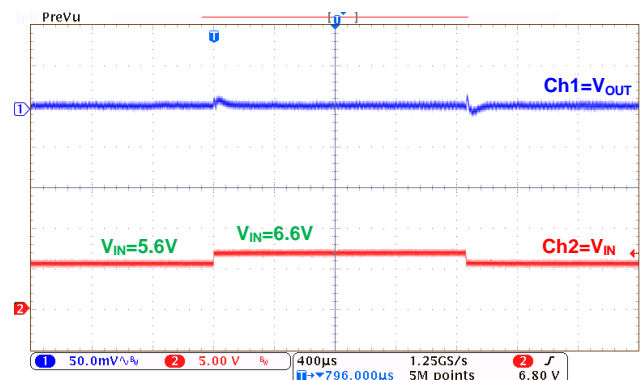

Line Transient at  $V_{OUT}=3.6V$   
7601B36( $I_{OUT}=1mA$ )

## ■ TYPICAL PERFORMANCE CHARACTERISTICS(CONTINUED)

Test Conditions:  $V_{IN}=V_{OUT}+2.0V$ ,  $C_{IN}=2.2\mu F$ ,  $C_{OUT}=2.2\mu F$ , unless otherwise indicated.

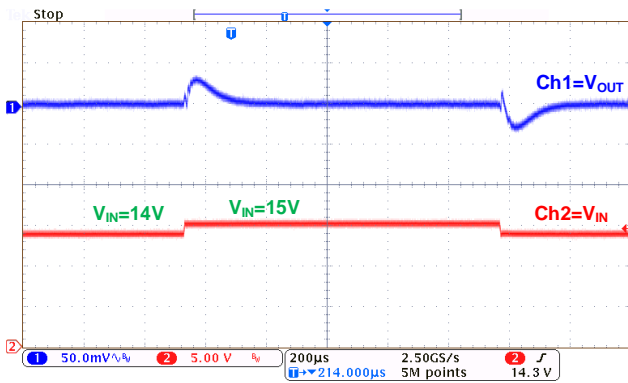

Line Transient at  $V_{OUT}=12V$   
7601A12( $I_{OUT}=10mA$ )

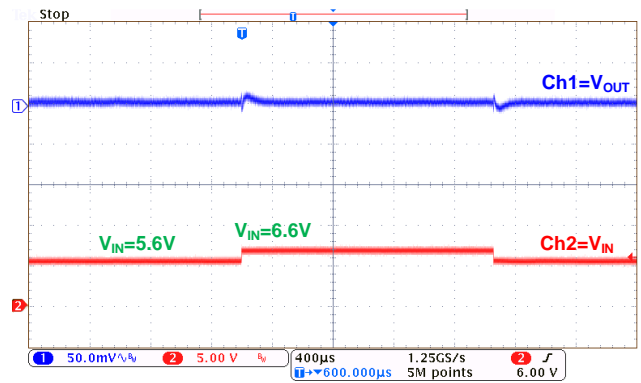

Line Transient at  $V_{OUT}=3.6V$   
7601B36( $I_{OUT}=10mA$ )

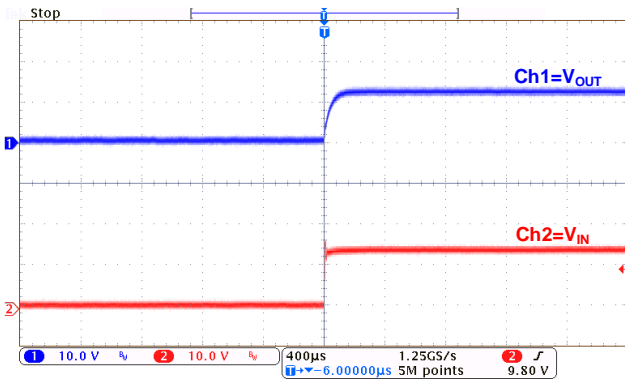

Power-Up at  $V_{OUT}=12V$   
7601A12( $I_{OUT}=0mA$ )

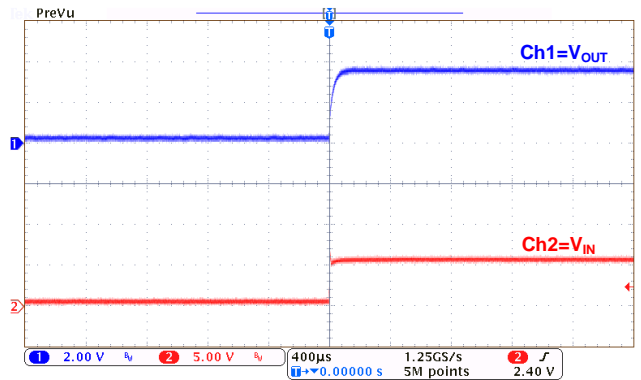

Power-Up at  $V_{OUT}=3.6V$   
7601B36( $I_{OUT}=0mA$ )

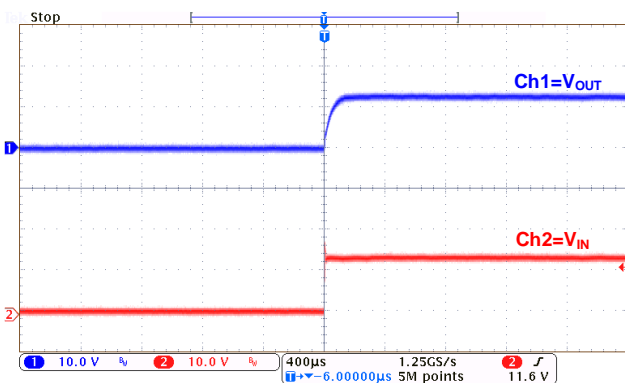

Power-Up at  $V_{OUT}=12V$   
7601A12( $I_{OUT}=1A$ )

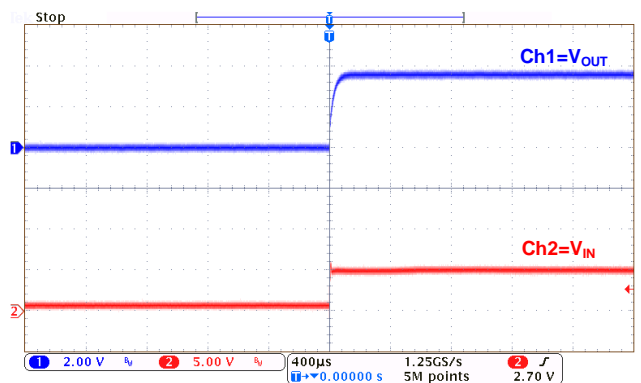

Power-Up at  $V_{OUT}=3.6V$   
7601B36( $I_{OUT}=1A$ )



## ■ TYPICAL PERFORMANCE CHARACTERISTICS(CONTINUED)

Test Conditions:  $V_{IN}=V_{OUT}+2.0V$ ,  $C_{IN}=2.2\mu F$ ,  $C_{OUT}=2.2\mu F$ , unless otherwise indicated.

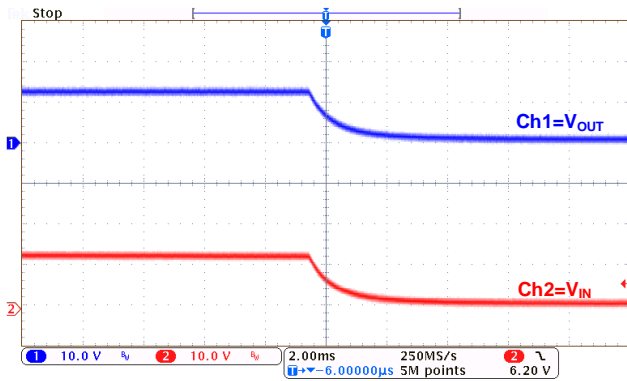

Power-Down at  $V_{OUT}=12V$   
7601A12( $I_{OUT}=0mA$ )

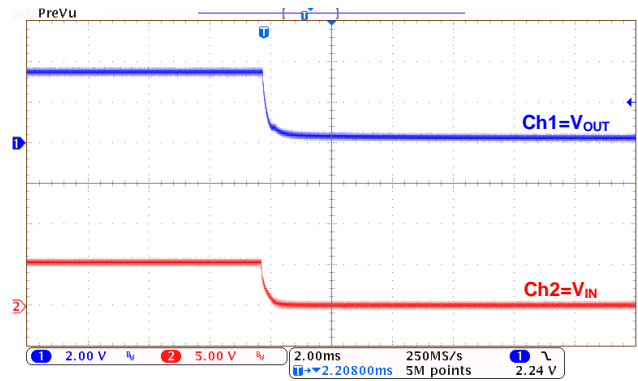

Power-Down at  $V_{OUT}=3.6V$   
7601B36( $I_{OUT}=0mA$ )

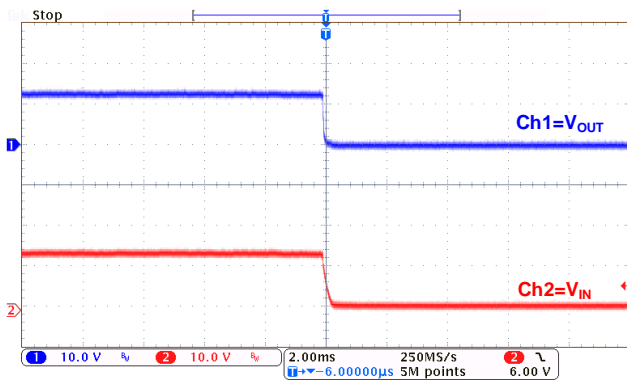

Power-Down at  $V_{OUT}=12V$   
7601A12( $I_{OUT}=1A$ )

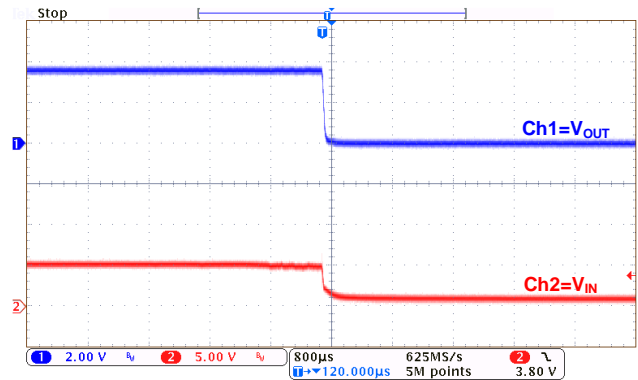

Power-Down at  $V_{OUT}=3.6V$   
7601B36( $I_{OUT}=1A$ )

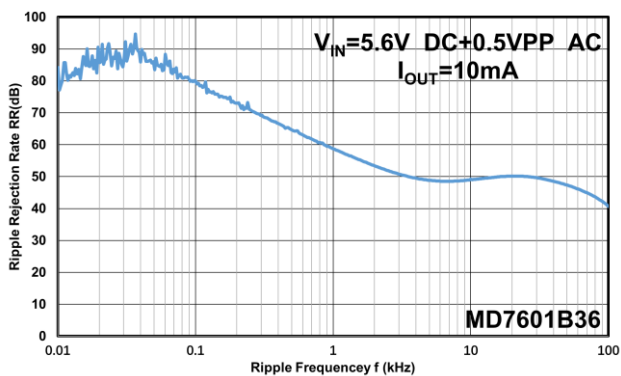

Power Supply Rejection Ratio at  $V_{OUT}=3.6V$

## ■ OPERATIONAL EXPLANATION

### 1. Output voltage control

The voltage divided by resistors R1 and R2 is compared with the internal reference voltage by the error amplifier. The amplifier output then drives the P-channel MOSFET connected to the  $V_{OUT}$  pin. The output voltage at the  $V_{OUT}$  pin is regulated by this negative feedback system. The current limit circuit and short protect circuit operate in relation to output current level. Further, the IC's internal circuitry can be in operation or shutdown modes controlled by the CE pin's signal.

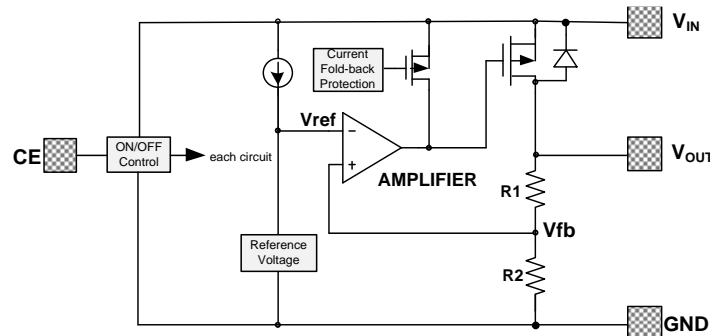

### 2. Pass transistor

The pass transistor with low turn-on resistance used in MD83XX is a P-channel MOSFET. If the potential on  $V_{OUT}$  pin is higher than  $V_{IN}$ , it is possible that IC will be destroyed due to reverse current which is caused by parasitic diodes between  $V_{IN}$  and  $V_{OUT}$ . Therefore, the  $V_{OUT}$  pin potential exceeds  $V_{IN}+0.3V$  is not allowed.

### 3. Current foldback and over temperature protection

The MD83XX series includes a combination of a fixed current limiter circuit and a foldback circuit, which aid the operations of the current limiter and circuit protection. When the load current reaches the current limit level, the fixed current limiter circuit operates and output voltage drops. As a result of this drop in output voltage, the foldback circuit operates, output voltage drops further and output current decreases. This design can prevent the chip be damaged due to over temperature, moreover, the heat dissipation is limited by the package type.

Special attention should be paid to that the product of the dropout voltage on the chip and the output current must be smaller than the heat dissipation. If power consumption on the chip is more than the heat dissipation, OTP will protect the chip from damaging due to over temperature.

## ■ Notes:

1. The input and output capacitors should be placed as close as possible to the IC.
2. If the impedance of the power supply is high, which is caused by forgetting installing input capacitor or installing too small value capacitor, the oscillation may occur.
3. Pay attention to the operation conditions of input and output voltage and load current, such that the power consumption in the IC should not exceed the allowable power consumption of the package even though the chip has short circuit protection.
4. IC has a built-in anti-static protection (ESD) circuit, but please do not add excessive stress to the IC.

■ PACKAGING INFORMATION

TO-252-2L PACKAGE OUTLINE DIMENSIONS

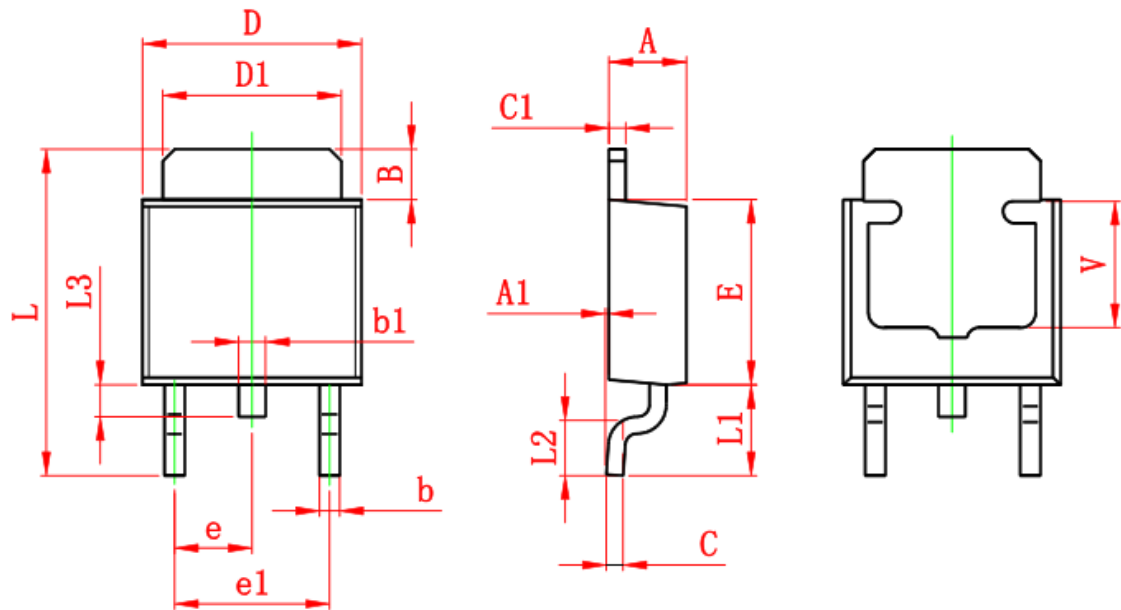

Symbol	Dimensions In Millimeters		Dimensions In Inches	
	Min.	Max.	Min.	Max.
A	2.200	2.400	0.087	0.094
A1	0.000	0.127	0.000	0.005
B	1.350	1.650	0.053	0.065
b	0.500	0.700	0.020	0.028
b1	0.700	0.900	0.028	0.035
c	0.430	0.580	0.017	0.023
c1	0.430	0.580	0.017	0.023
D	6.350	6.650	0.250	0.262
D1	5.200	5.400	0.205	0.213
E	5.400	5.700	0.213	0.224
e	2.300 TYP.		0.091 TYP.	
e1	4.500	4.700	0.177	0.185
L	9.500	9.900	0.374	0.390
L1	2.550	2.900	0.100	0.114
L2	1.400	1.780	0.055	0.070
L3	0.600	0.900	0.024	0.035
V	3.800 REF.		0.150 REF.	

■ PACKAGING INFORMATION(Continued)

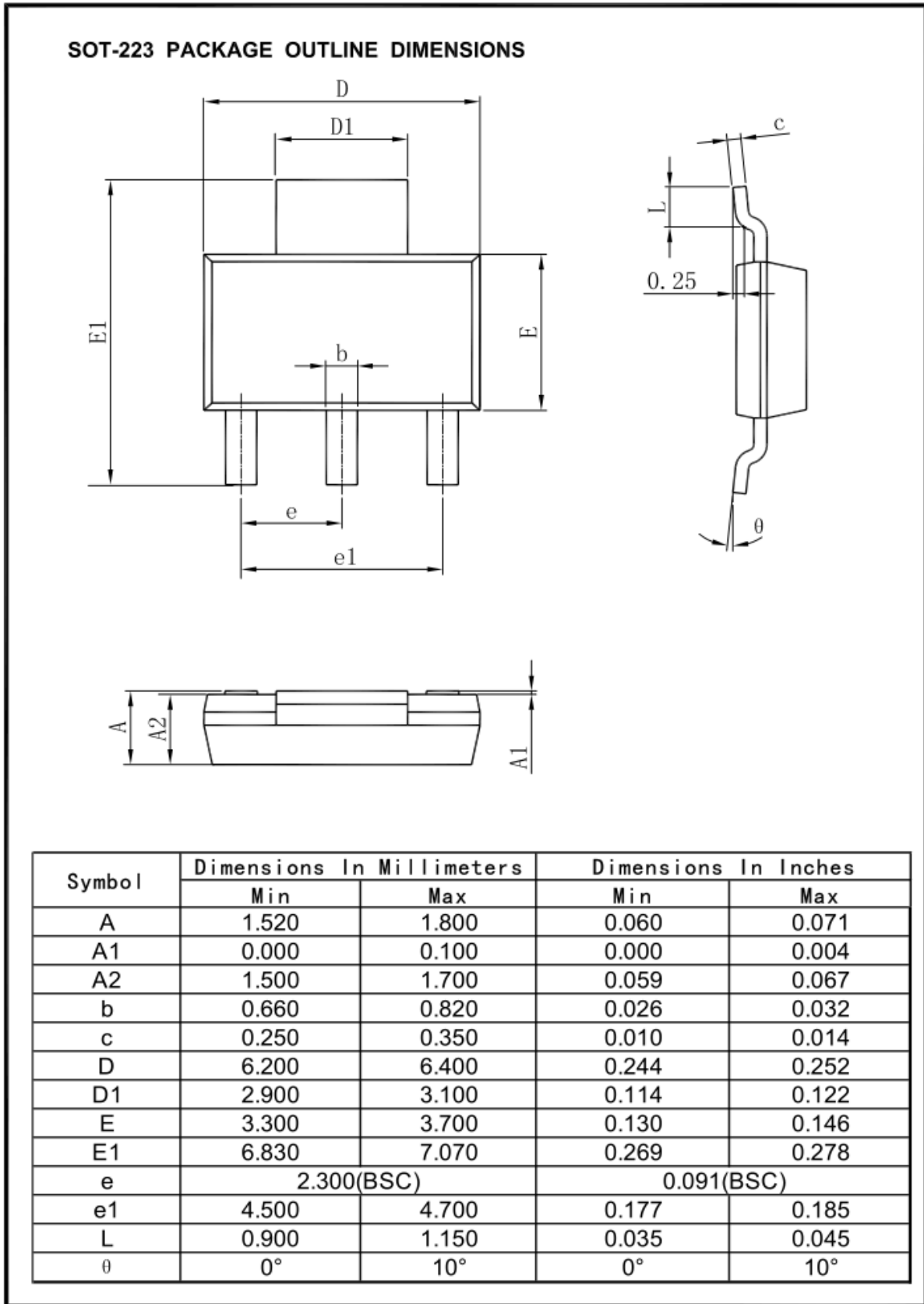

For the newest datasheet, please see the website:

[www.md-ic.com.cn](http://www.md-ic.com.cn)

Version V1.5: 20220906