

## 1200V, 75A, Trench FS II Fast IGBT

### General Description:

Using NCE's proprietary trench design and advanced FS (Field Stop) second generation technology, the 1200V Trench FSII IGBT offers superior conduction and switching performances, and easy parallel operation;

### Features

- Trench FSII Technology Offering
- Very low  $V_{CE(sat)}$
- High speed switching
- Positive temperature coefficient in  $V_{CE(sat)}$
- Very tight parameter distribution
- High ruggedness, temperature stable behavior

### Application

- PV power
- Three-level Solar String Inverter
- UPS



Schematic diagram

### Package Marking and Ordering Information

Device	Device Package	Device Marking
NCE75TD120VTP	TO-247P	NCE75TD120VTP

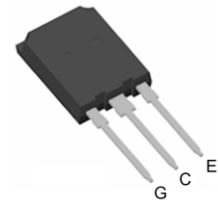

TO-247P

### Absolute Maximum Ratings ( $T_C=25^\circ\text{C}$ unless otherwise noted)

Symbol	Parameter	Value	Units
$V_{CES}$	Collector-Emitter Voltage	1200	V
$V_{GES}$	Gate- Emitter Voltage	$\pm 30$	V
$I_C$	Collector Current	150	A
	Collector Current @ $T_C = 100^\circ\text{C}$	75	A
$I_{Cpuls}$	Pulsed Collector Current, $t_p$ limited by $T_{jmax}$	300	A
-	Turn off safe operating area, $V_{CE}=1200\text{V}$ , $T_J=175^\circ\text{C}$	300	A
$I_F$	Diode Continuous Forward Current @ $T_C = 100^\circ\text{C}$	75	A
$I_{FM}$	Diode Maximum Forward Current	300	A
$P_D$	Power Dissipation @ $T_C = 25^\circ\text{C}$	833	W
	Power Dissipation @ $T_C = 100^\circ\text{C}$	417	W
$T_J, T_{stg}$	Operating Junction and Storage Temperature Range	-55 to +175	$^\circ\text{C}$
$T_L$	Maximum Temperature for Soldering	260	$^\circ\text{C}$

**Thermal Characteristic**

Symbol	Parameter	Value	Units
R <sub>θJC</sub>	Thermal Resistance, Junction to case for IGBT	0.18	°C/W
R <sub>θJC</sub>	Thermal Resistance, Junction to case for Diode	0.40	°C/W
R <sub>θJA</sub>	Thermal Resistance, Junction to Ambient	40	°C/W

**Electrical Characteristics (T<sub>c</sub>=25°C unless otherwise noted)**

Symbol	Parameter	Conditions	Value			Units	
			Min.	Typ.	Max.		
<b>Static Characteristics</b>							
V <sub>(BR)CES</sub>	Collector-Emitter Breakdown Voltage	V <sub>GE</sub> =0V, I <sub>CE</sub> =3mA	1200	--	--	V	
I <sub>CES</sub>	Collector-Emitter Leakage Current	V <sub>GE</sub> =0V, V <sub>CE</sub> =1200V	--	--	400	μA	
I <sub>GES(F)</sub>	Gate to Emitter Forward Leakage	V <sub>GE</sub> =+30V, V <sub>CE</sub> =0V	--	--	200	nA	
I <sub>GES(R)</sub>	Gate to Emitter Reverse Leakage	V <sub>GE</sub> =-30V, V <sub>CE</sub> =0V	--	--	200	nA	
V <sub>CE(sat)</sub>	Collector-Emitter Saturation Voltage	I <sub>C</sub> =75A, T <sub>J</sub> =25°C	--	1.70	1.95	V	
		V <sub>GE</sub> =15V, T <sub>J</sub> =175°C	--	1.95	--	V	
V <sub>GE(th)</sub>	Gate Threshold Voltage	I <sub>C</sub> =3mA, V <sub>CE</sub> =V <sub>GE</sub>	4.5	--	6.0	V	
<b>Dynamic Characteristics</b>							
C <sub>ies</sub>	Input Capacitance	V <sub>CE</sub> =30V, V <sub>GE</sub> =0V, f=1MHz	--	9747	--	pF	
C <sub>oes</sub>	Output Capacitance		--	327	--		
C <sub>res</sub>	Reverse Transfer Capacitance		--	271	--		
Q <sub>g</sub>	Total Gate Charge	V <sub>CC</sub> =960V, I <sub>C</sub> =75A, V <sub>GE</sub> =15V	--	572	--	nC	
Q <sub>ge</sub>	Gate to Emitter Charge		--	69	--		
Q <sub>gc</sub>	Gate to Collector Charge		--	368	--		
<b>Switching Characteristics</b>							
t <sub>d(ON)</sub>	Turn-on Delay Time	V <sub>CE</sub> =600V, I <sub>C</sub> =75A, V <sub>GE</sub> =0/15V, R <sub>g</sub> =8Ω Inductive Load	--	19	--	ns	
t <sub>r</sub>	Rise Time		--	17	--		
t <sub>d(OFF)</sub>	Turn-Off Delay Time		--	170	--		
t <sub>f</sub>	Fall Time		--	18	--		
E <sub>on</sub>	Turn-On Switching Loss		V <sub>CE</sub> =600V, I <sub>C</sub> =75A, V <sub>GE</sub> =0/15V, R <sub>g</sub> =8Ω	--	5.6	--	mJ
E <sub>off</sub>	Turn-Off Switching Loss			--	2.7	--	
E <sub>ts</sub>	Total Switching Loss			--	8.3	--	
E <sub>on</sub>	Turn-On Switching Loss		V <sub>CE</sub> =600V, I <sub>C</sub> =75A, V <sub>GE</sub> =0/15V, R <sub>g</sub> =8Ω T <sub>J</sub> =175°C	--	7.1	--	mJ
E <sub>off</sub>	Turn-Off Switching Loss			--	3.6	--	
E <sub>ts</sub>	Total Switching Loss	--		10.7	--		

**Electrical Characteristics of the Diode (T<sub>c</sub>= 25°C unless otherwise specified)**

Symbol	Parameter	Conditions	Rating			Units
			Min.	Typ.	Max.	
V <sub>FM</sub>	Diode Forward Voltage	I <sub>F</sub> =75A	--	2.2	2.8	V
T <sub>rr</sub>	Reverse Recovery Time	I <sub>F</sub> =37.5A, di/dt=800A/us	--	180	--	ns
I <sub>RRM</sub>	Diode Peak Reverse Recovery Current		--	29	--	A
Q <sub>rr</sub>	Reverse Recovery Charge		--	4.3	--	μC

Test Circuit

1) Gate Charge Test Circuit

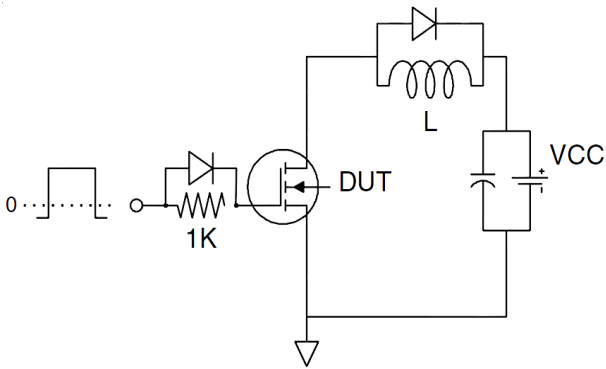

2) Switch Time Test Circuit

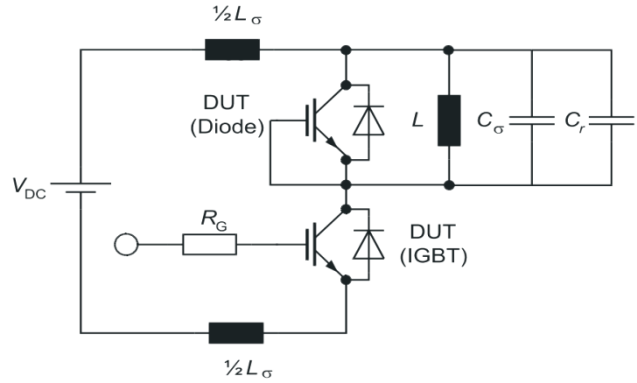

Switching characteristics

1) Definition of switching times

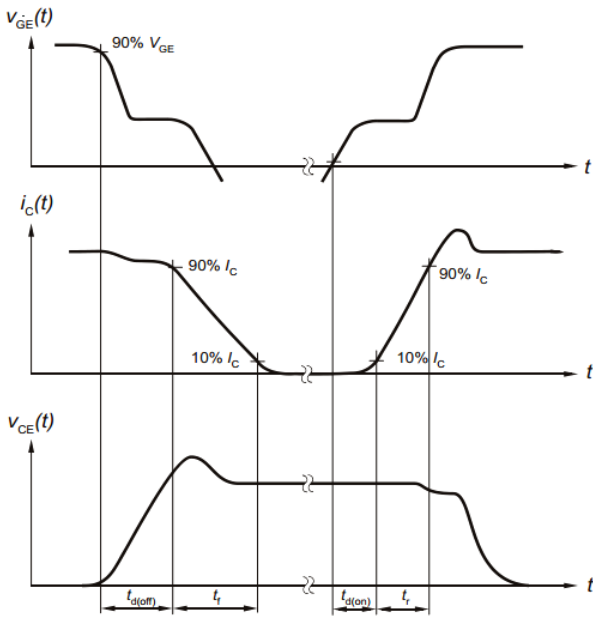

2) Definition of switching losses

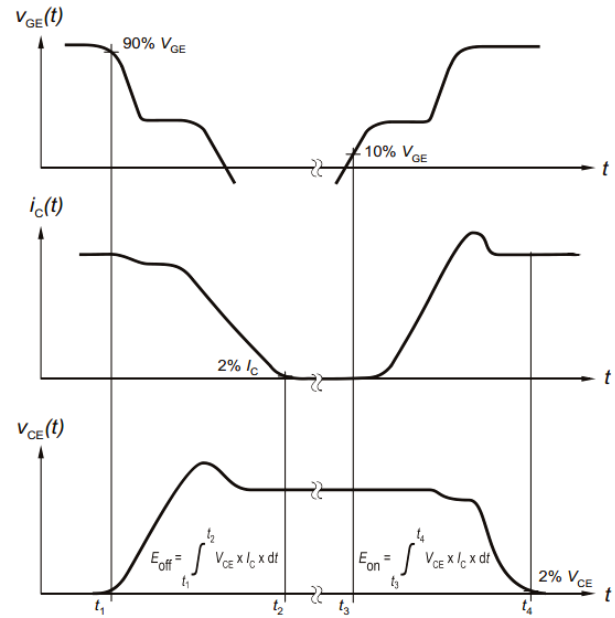

3) Definition of diode switching characteristics

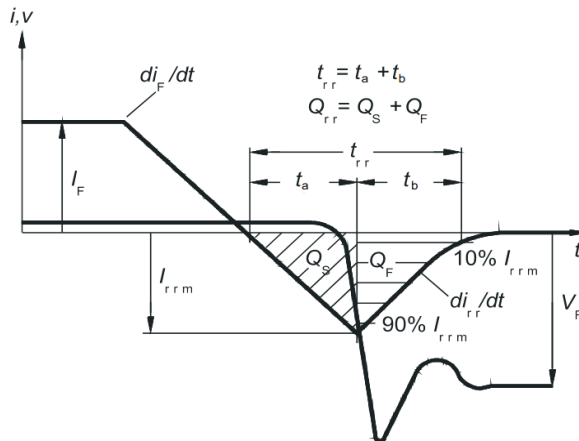

Typical Electrical and Thermal Characteristics

Figure 1 Output Characteristics

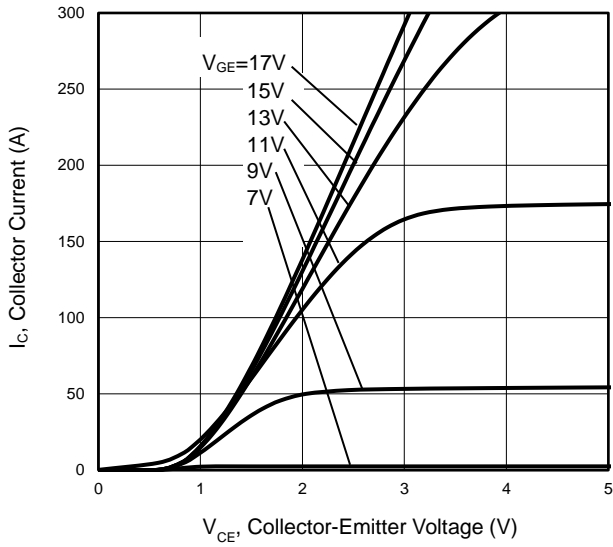

Figure 2 Transfer Characteristics

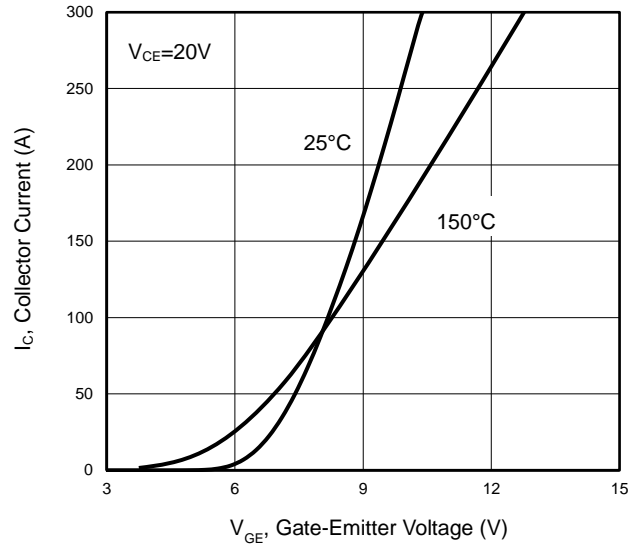

Figure 3  $V_{CE(sat)}$  vs. Case Temperature

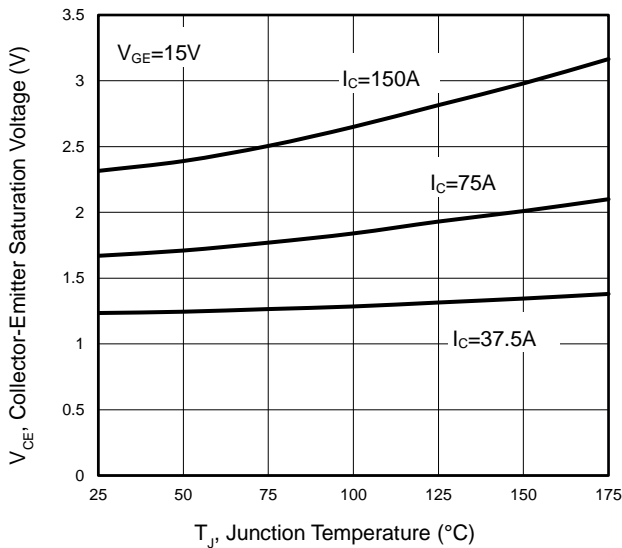

Figure 4 Saturation Voltage vs.  $V_{GE}$

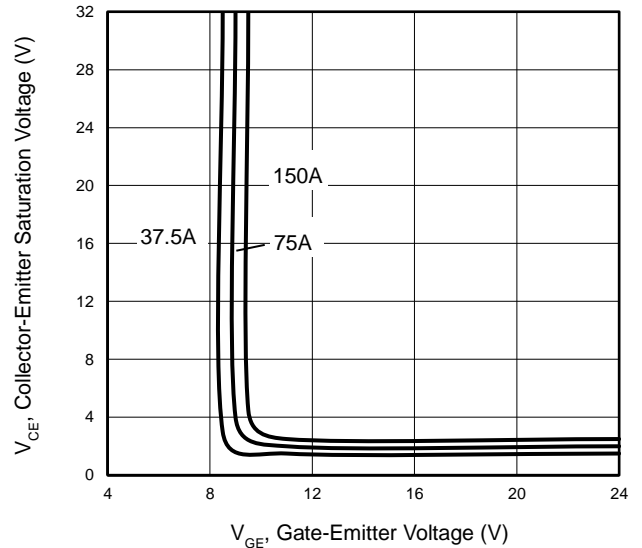

Figure 5 Capacitance Characteristics

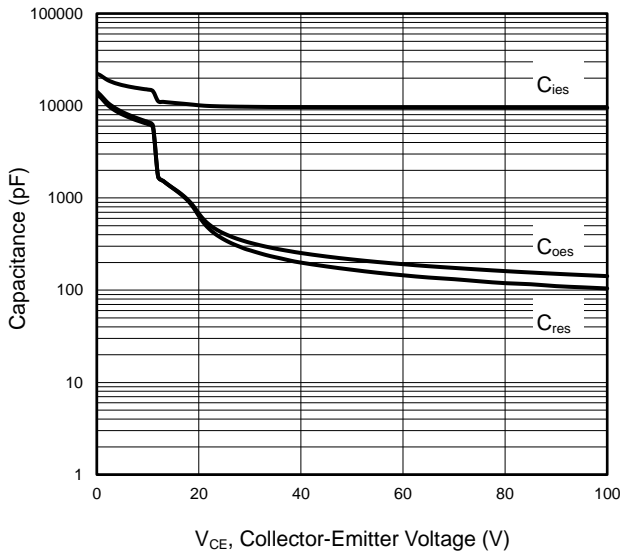
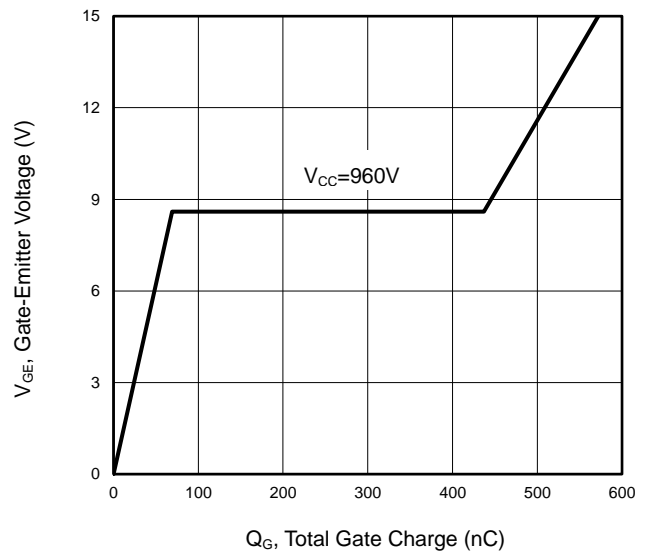

Figure 6 Gate Charge Wave Form



Typical Electrical and Thermal Characteristics

Figure 7 Forward Characteristics

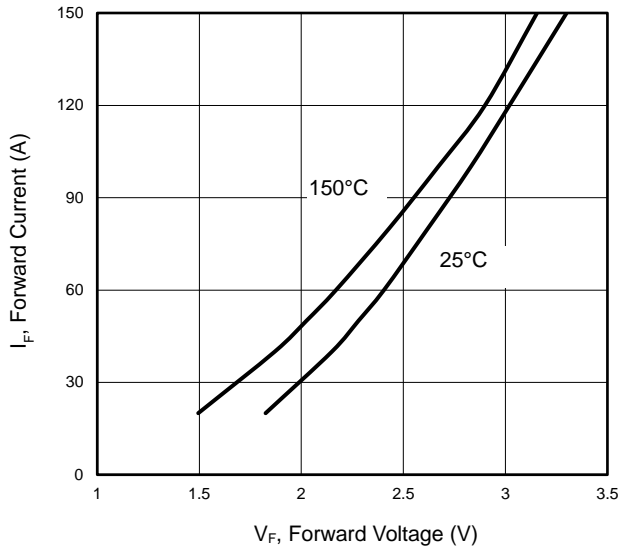

Figure 8  $V_F$  vs. Temperature

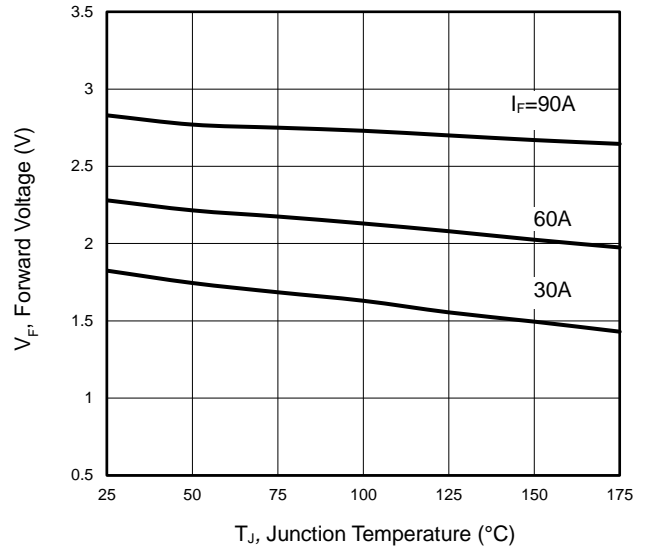

Figure 9 Switching Energy vs. Temperature

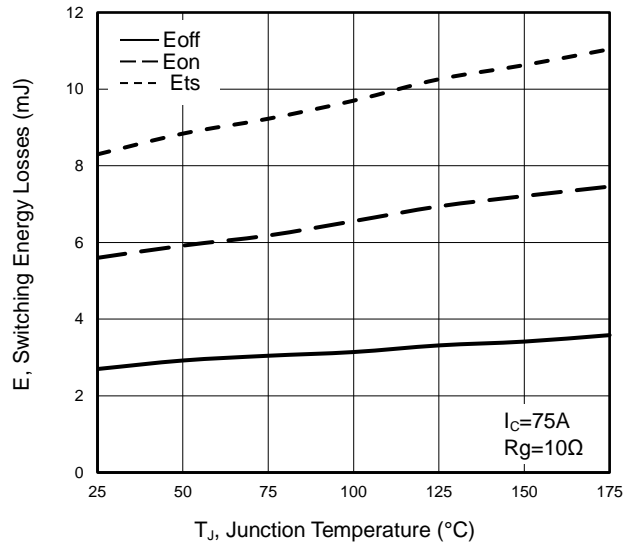

Figure 10 Forward Bias Safe Operating Area

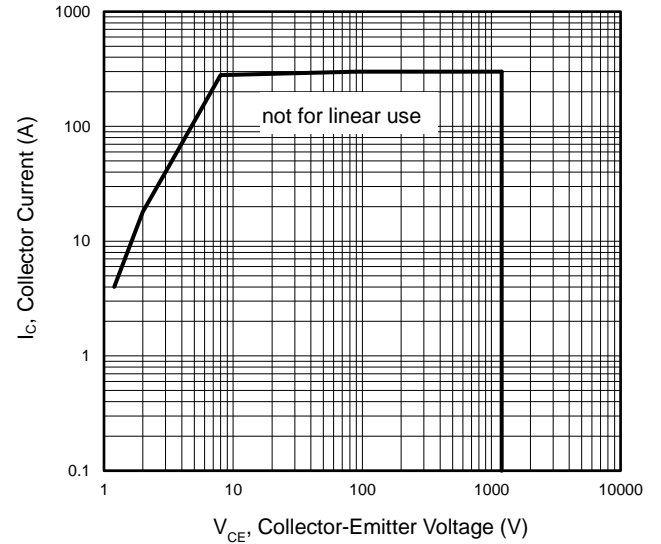

Figure 11 Gate-Emitter Threshold Voltage as a Function of Junction Temperature

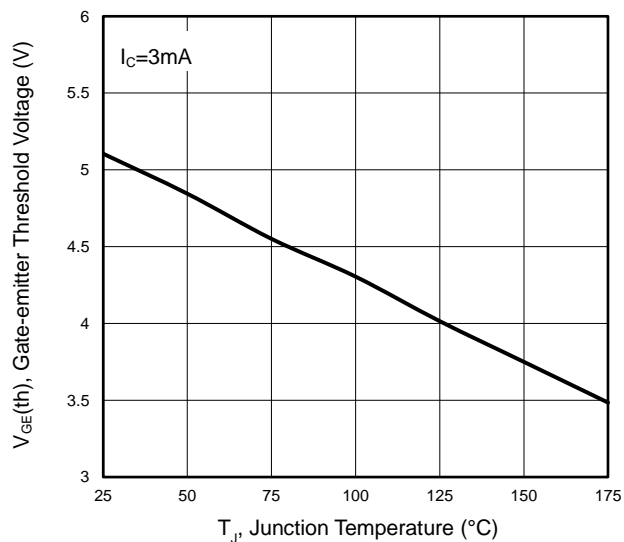
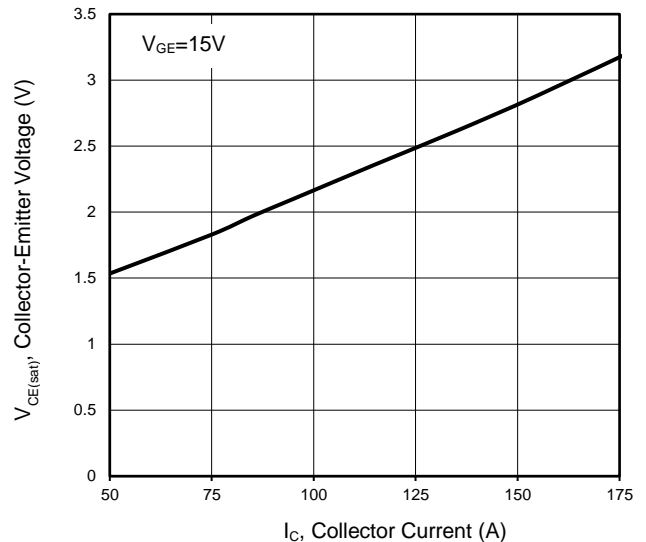

Figure 12 Typical Collector-Emitter Saturation Voltage as a function of Collector Current



Typical Electrical and Thermal Characteristics

Figure 13 Switching Loss vs.  $R_G$

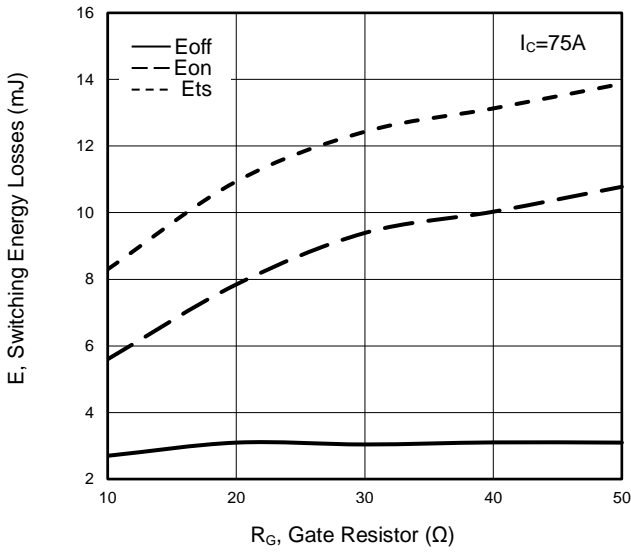

Figure 14 Switching Loss vs. Collector Current

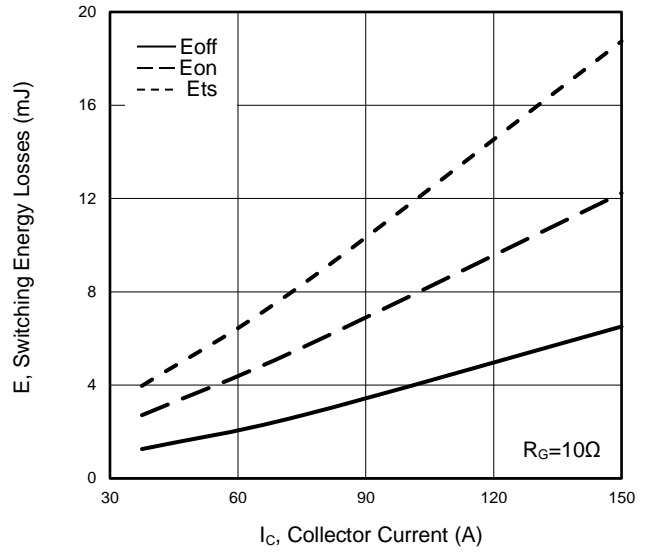

Figure 15 Switching Loss vs. Collector Current

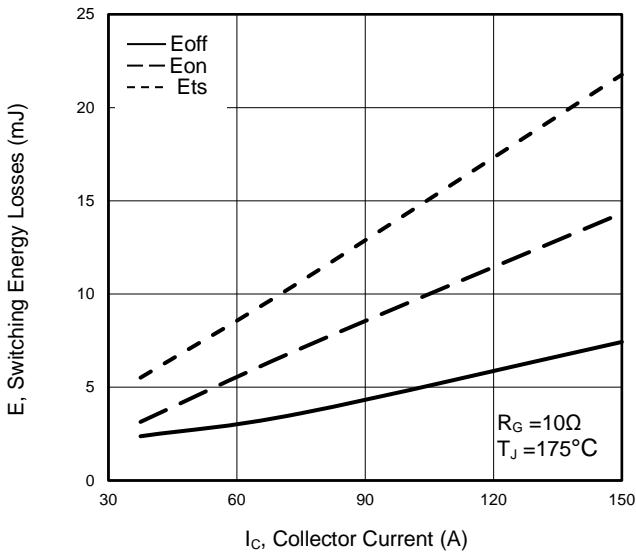

Figure 16  $P_{tot}$  vs. Case Temperature

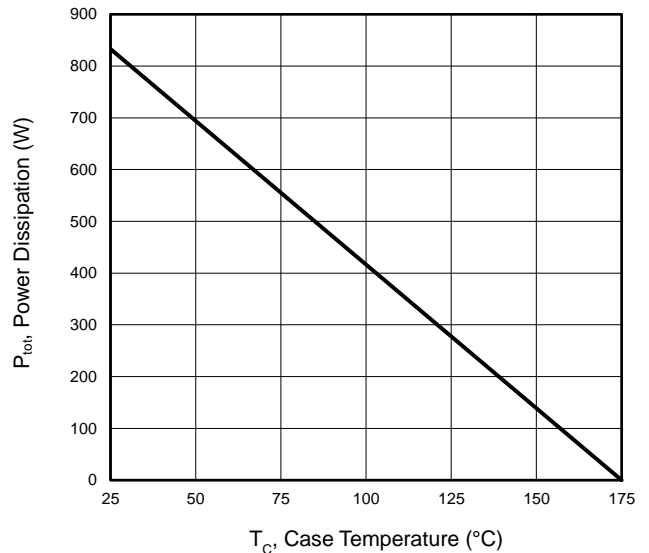

Figure 17  $V_{CES}$  vs. Case Temperature

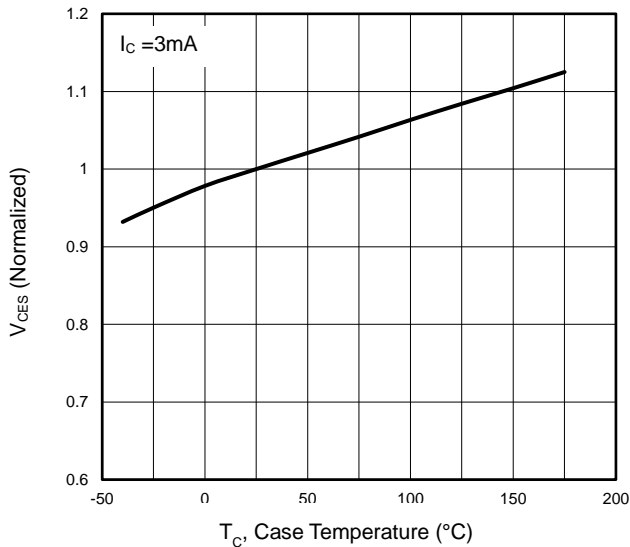
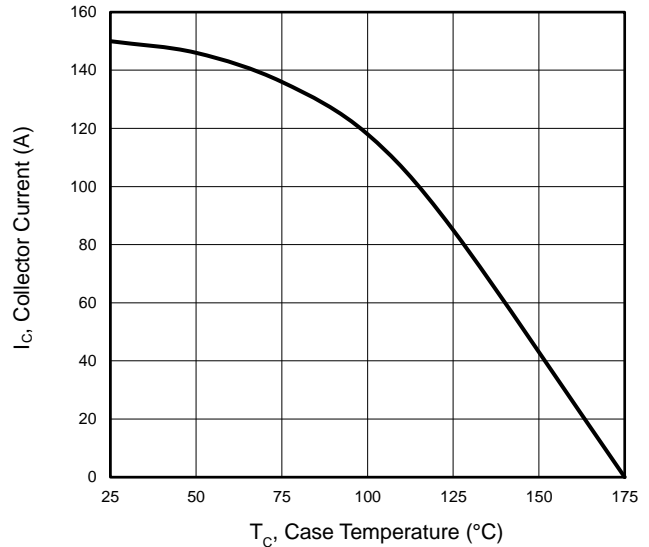

Figure 18  $I_C$  vs. Temperature



Typical Electrical and Thermal Characteristics

Figure 19 Switching Time vs.  $I_C$

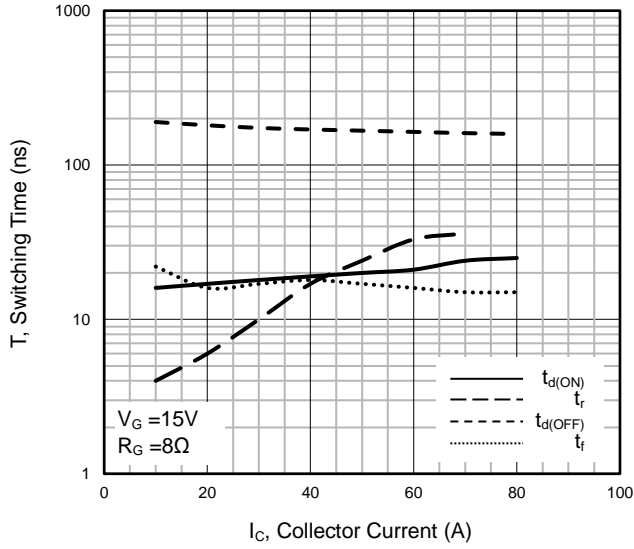

Figure 20 Switching Time vs.  $R_G$

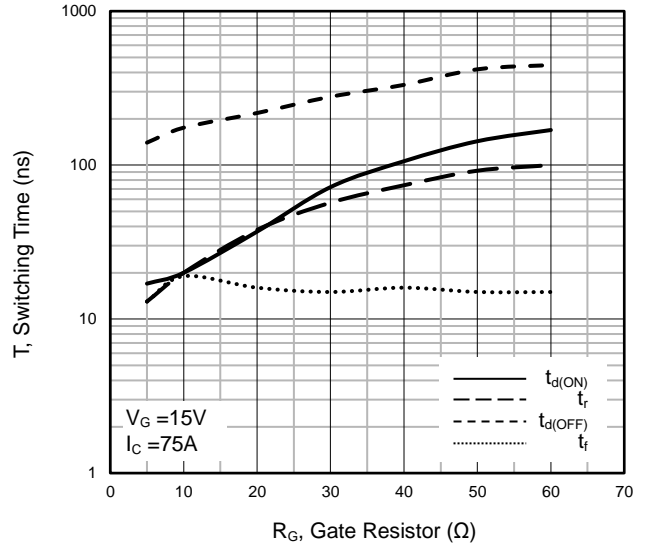

Figure 21 Switching Time vs.  $I_C$

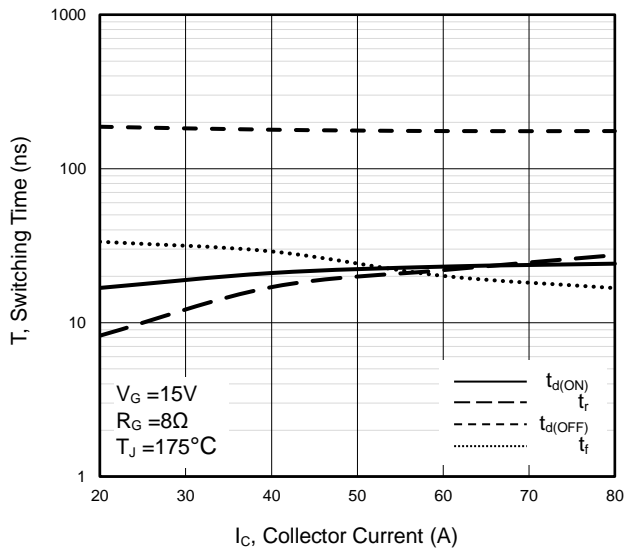
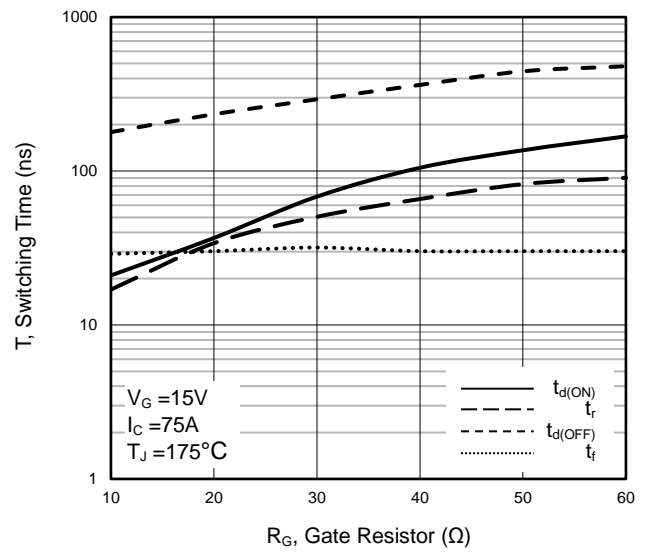
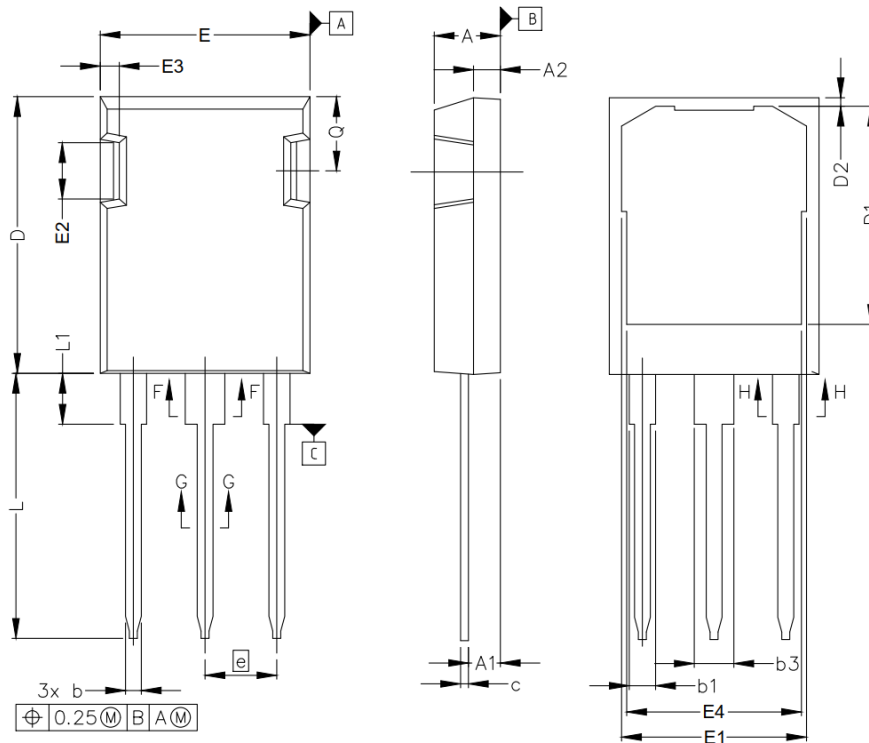

Figure 22 Switching Time vs.  $R_G$



## TO-247P-B Package Information



Symbol	Dimensions In Millimeters		Dimensions In Inches	
	Min.	Max.	Min.	Max.
A	4.83	5.21	0.19	0.21
A1	2.29	2.54	0.09	0.10
A2	1.91	2.16	0.08	0.09
b	1.07	1.33	0.04	0.05
b1	1.91	2.41	0.08	0.09
b3	2.87	3.38	0.11	0.13
c	0.55	0.68	0.02	0.03
D	20.80	21.10	0.82	0.83
D1	16.25	17.65	0.64	0.69
D2	0.50	0.80	0.02	0.03
E	15.75	16.13	0.62	0.64
E1	13.10	14.15	0.52	0.56
E2	3.68	5.10	0.14	0.20
E3	1.00	1.90	0.04	0.07
E4	12.38	13.43	0.49	0.53
e	5.44BSC		0.21	
N	3.00		0.12	
L	19.81	20.32	0.78	0.80
L1	3.70	4.00	0.15	0.16
Q	5.49	6.00	0.22	0.24



## TO-247P-P Package Information

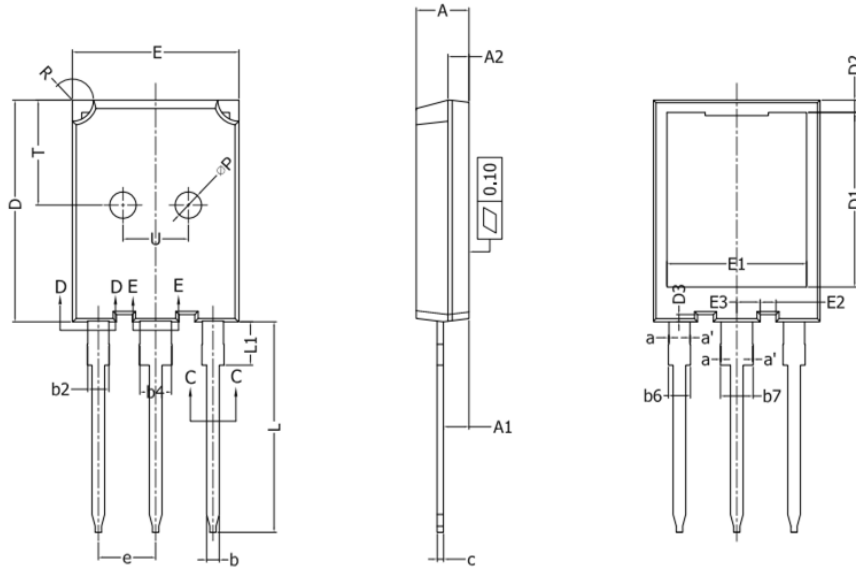

Symbol	Dimensions In Millimeters		Dimensions In Inches	
	Min.	Max.	Min.	Max.
A	4.90	5.10	0.193	0.201
A1	2.31	2.51	0.091	0.099
A2	1.90	2.10	0.075	0.083
a、a'	0.00	0.15	0.000	0.006
b	1.16	1.26	0.046	0.050
b2	1.96	2.06	0.077	0.081
b4	2.96	3.06	0.117	0.120
b6	-	2.25	-	0.089
b7	-	3.25	-	0.128
c	0.59	0.66	0.023	0.026
D	20.90	21.10	0.823	0.831
D1	16.25	16.85	0.640	0.663
D2	1.05	1.35	0.041	0.053
D3	0.58	0.78	0.023	0.031
E	15.70	15.90	0.618	0.626
E1	13.10	13.50	0.516	0.531
E2	1.40	1.60	0.055	0.063
E3	2.12	2.32	0.083	0.091
e	5.436 BSC		0.214 BSC	
L	19.80	20.10	0.780	0.791
L1	-	4.30	-	0.169
P	2.40	2.60	0.094	0.102
R	1.90	2.10	0.075	0.083
T	9.80	10.20	0.386	0.402
U	6.00	6.40	0.236	0.252

## TO-247P-d Package Information

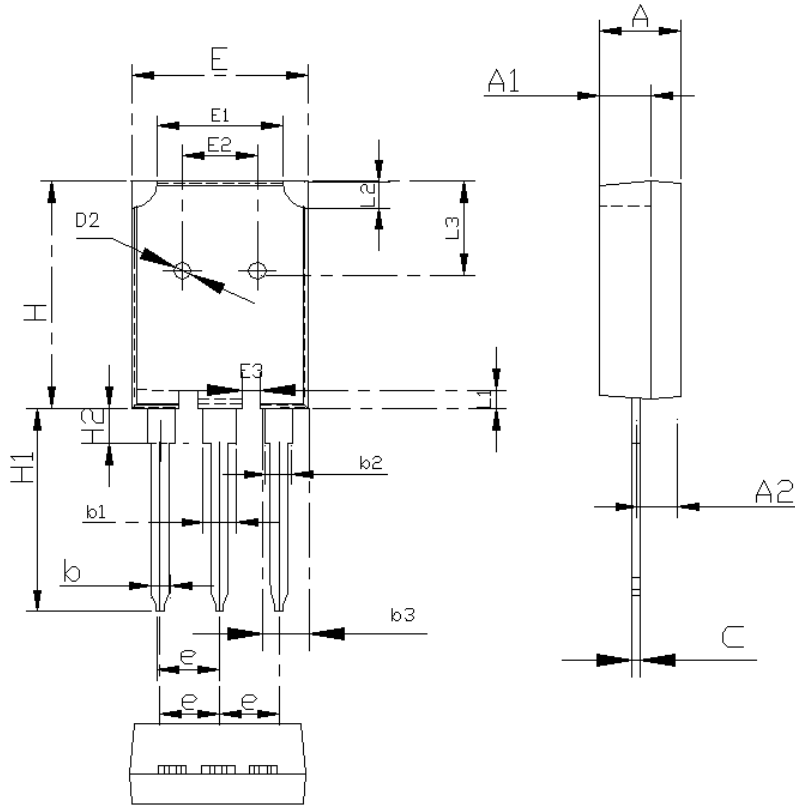

Symbol	Dimensions In Millimeters		Dimensions In Inches	
	Min.	Max.	Min.	Max.
A	4.80	5.20	0.189	0.205
A1	2.80	3.20	0.110	0.126
A2	1.80	2.20	0.071	0.087
b	1.00	1.40	0.039	0.055
b1	2.90	3.30	0.114	0.130
b2	1.90	2.30	0.075	0.091
b3	3.90	4.30	0.154	0.169
c	0.45	0.75	0.018	0.030
e	5.25	5.65	0.207	0.222
E	15.60	16.00	0.614	0.630
E1	10.20	11.00	0.402	0.433
E2	6.30	6.90	0.248	0.272
E3	1.60	2.00	0.063	0.079
L1	0.35	0.65	0.014	0.026
L2	1.80	2.20	0.071	0.087
L3	9.50	10.50	0.374	0.413
H	20.50	21.50	0.807	0.846
H1	19.50	20.50	0.768	0.807
H2	3.50	4.50	0.138	0.177

**Attention:**

- Any and all NCE power products described or contained herein do not have specifications that can handle applications that require extremely high levels of reliability, such as life-support systems, aircraft's control systems, or other applications whose failure can be reasonably expected to result in serious physical and/or material damage. Consult with your NCE power representative nearest you before using any NCE power products described or contained herein in such applications.
- NCE power assumes no responsibility for equipment failures that result from using products at values that exceed, even momentarily, rated values (such as maximum ratings, operating condition ranges, or other parameters) listed in products specifications of any and all NCE power products described or contained herein.
- Specifications of any and all NCE power products described or contained herein stipulate the performance, characteristics, and functions of the described products in the independent state, and are not guarantees of the performance, characteristics, and functions of the described products as mounted in the customer's products or equipment. To verify symptoms and states that cannot be evaluated in an independent device, the customer should always evaluate and test devices mounted in the customer's products or equipment.
- NCE power Semiconductor CO.,LTD. strives to supply high-quality high-reliability products. However, any and all semiconductor products fail with some probability. It is possible that these probabilistic failures could give rise to accidents or events that could endanger human lives, that could give rise to smoke or fire, or that could cause damage to other property. When designing equipment, adopt safety measures so that these kinds of accidents or events cannot occur. Such measures include but are not limited to protective circuits and error prevention circuits for safe design, redundant design, and structural design.
- In the event that any or all NCE power products(including technical data, services) described or contained herein are controlled under any of applicable local export control laws and regulations, such products must not be exported without obtaining the export license from the authorities concerned in accordance with the above law.
- No part of this publication may be reproduced or transmitted in any form or by any means, electronic or mechanical, including photocopying and recording, or any information storage or retrieval system, or otherwise, without the prior written permission of NCE power Semiconductor CO.,LTD.
- Information (including circuit diagrams and circuit parameters) herein is for example only ; it is not guaranteed for volume production. NCE power believes information herein is accurate and reliable, but no guarantees are made or implied regarding its use or any infringements of intellectual property rights or other rights of third parties.
- Any and all information described or contained herein are subject to change without notice due to product/technology improvement, etc. When designing equipment, refer to the "Delivery Specification" for the NCE power product that you intend to use.
- This catalog provides information as of Sep.2010. Specifications and information herein are subject to change without notice.