



# SPECIFICATION

## Surface Acoustic Wave Filter

USER



USER PART No.

WISOL PART No. **SFX831AYJ02**

DOC. No. **SMS-51-L-SFT-FS-228**

DATE January 7, 2020

REVISION 000

WISOL					
ISSUED BY	Park, Jae-hyung 	APPROVED BY (R&D)	Ha, Sang-Ki 	APPROVED BY (QC)	Jeon, Jong-Hee 
User					
ISSUED BY		CHECKED BY		APPROVED BY	

WISOL CO., LTD.  
531-7, Gajang-ro, Osan-si,  
Gyeonggi-do, KOREA, 18103  
<http://www.wisol.co.kr>

▶ **A TABLE OF CONTENTS**

<b>1. REVISION HISTORY</b> .....	3
<b>2. DEFINITION</b> .....	4
<b>3. PRECAUTIONS</b> .....	4
<b>4. OUTLINE DRAWING &amp; DIMENSIONS</b> .....	5
<b>5. MARKING</b> .....	6
<b>6. PERFORMANCE</b> .....	7
6-1. MAXIMUM RATINGS .....	7
6-2. ELECTRICAL CHARACTERISTICS .....	7
<b>7. RELIABILITY</b> .....	12
7-1. ENGINEERING SAMPLE FLOW CHART .....	12
7-2. TEST ITEM & CONDITION .....	13
<b>8. REFLOW CONDITION</b> .....	14
<b>9. RECOMMENDED PCB DIMENSIONS</b> .....	14
<b>10. CAUTION</b> .....	15
<b>11. PACKING</b> .....	16
11-1. DIMENSIONS .....	16
11-2. REELING QUANTITY .....	17
11-3. TAPING STRUCTURE .....	17
11-4. INNER BOX(Reel Packing) STRUCTURE .....	18
11-5. OUTER BOX STRUCTURE .....	19
<b>12. TAPE SPECIFICATIONS</b> .....	20
<b>13. RoHS DATA</b> .....	21
13-1. RAW MATERIAL(EPOXY) .....	21
13-2. RAW MATERIAL(PACKAGE) .....	29
13-3. RAW MATERIAL(LN WAFER) .....	33
13-4. RAW MATERIAL(GOLD WIRE) .....	42

## 1. REVISION HISTORY

000	January 7, 2020	All Page	Make specification
-----	-----------------	----------	--------------------

## 2. DEFINITION

2-1. PART No.

**S F X 8 3 1 A Y J 0 2**

①      ②      ③      ④      ⑤      ⑥

No.	EXPLANATION
①	SAW Filter
②	Design Type
③	Center Frequency :831.5MHz(814 ~ 849)
④	Input:50ohm,Output:50ohm
⑤	Package size: 1.8×1.4mm <sup>2</sup>
⑥	Design Revision (02 : Molding Type)

2-2. APPLICATION : LTE BAND26 Unbalanced DPX

2-3. SPEC

ESD Level    HBM=300V

## 3. PRECAUTIONS

3-1. This device should not be used in any type of fluid such as water, oil, organic solvent, etc.

3-2. This is a hermetic device.

MSL(Moisture Sensitive Level) is the '2a' level.

3-3. Ultrasonic cleaning shall be avoided.

3-4. Isopropyl Alcohol and Ethyl Alcohol can be used for cleaning. Contact us before using other cleaning solvents than above

3-5. This is an electrostatic sensitive device.

Please avoid static voltage during operation and storage.

3-6. Sudden change of temperature shall be avoided, deterioration of the characteristics can occur.

3-7. If any malfunction due to designing or manufacturing which is out of specification occurs within one year after the products have been delivered, the maker should exchange the defective products.

#### 4. OUTLINE DRAWING & DIMENSIONS

[Unit: mm]

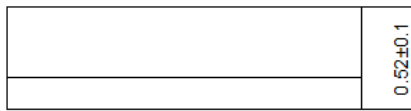
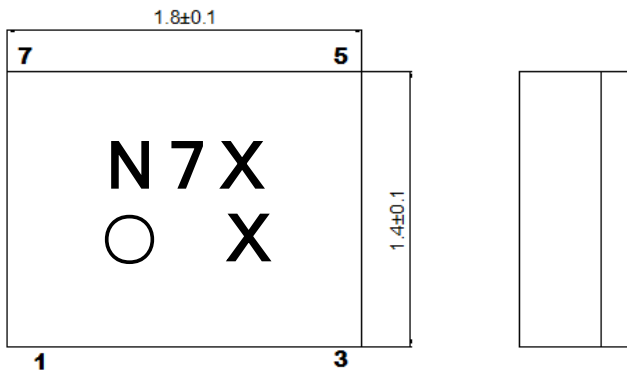

No.	Function
1	Rx Output
3	Tx Input
6	Antenna
2, 4, 5, 7, 8	GND

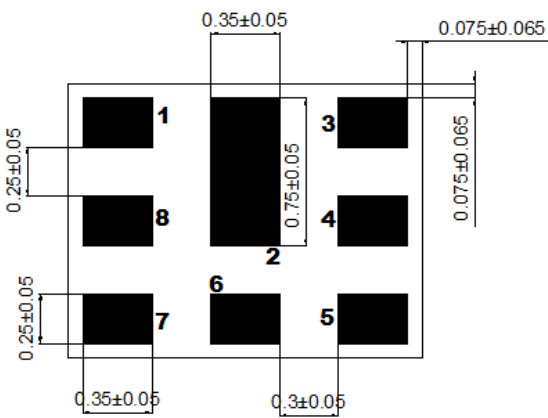

## 5. MARKING



### 5-1. N 7 X X

- The 1<sup>st</sup> 2<sup>nd</sup> character 'N7' indicates the model name of SAW Filter SFX831AYJ02.
- The 3<sup>rd</sup> character 'X' indicates the year and the month of manufacture.

Year	Month											
	1	2	3	4	5	6	7	8	9	10	11	12
<b>2017</b>	1	2	3	4	5	6	7	8	9	A	B	C
<b>2018</b>	D	E	F	G	H	I	J	K	L	M	N	O
<b>2019</b>	P	Q	R	S	T	U	V	W	X	Y	Z	a
<b>2020</b>	1	2	3	4	5	6	7	8	9	A	B	C

※ This rotates by the 3 years.

- The 5<sup>th</sup> character 'X' indicates Date of manufacture

DATE	1	2	3	4	5	6	7	8	9	10	11	12	13	14	15	
MARKING	1	2	3	4	5	6	7	8	9	A	B	C	D	E	F	
DATE	16	17	18	19	20	21	22	23	24	25	26	27	28	29	30	31
MARKING	G	H	I	J	K	L	M	N	O	P	Q	R	S	T	U	V

### 5-2. ○

- This symbol indicates input pin 1.
- This indicates the producing center
  - : China

### 5-3. Marking : Laser Marking

## 6. PERFORMANCE

### 6-1. MAXIMUM RATINGS

CHARACTERISTICS	RATINGS	UNITS	NOTES
DC Permissive Voltage	5	V	
Input Power	29	dBm	55 °C, 5000 h
Operating Temperature Range	- 20 ~ +85	°C	
Storage Temperature Range	- 40 ~ +85	°C	

### 6-2. ELECTRICAL CHARACTERISTICS

#### 6-2-1. TABLE

Ta = - 20 ~ +85°C

Item	CONDITION [MHz]	UNIT	RATING		
			Min.	Typ.(25°C)	Max.
TX → ANTENNA					
Insertion Loss	814.25 ~ 848.75	dB	-	2.0	3.0
Inband Ripple	814.25 ~ 848.75	dB	-	1.0	2.3
VSWR	814.25 ~ 848.75	-	-	1.8	2.4
Absolute Attenuation	10 ~ 420	dB	30	43	-
	420~ 494	dB	30	41	-
	494 ~ 701	dB	20	40	-
	859.25 ~893.75	dB	44	52	-
	1559 ~ 1563	dB	35	40	-
	1565.42 ~ 1605.89	dB	35	39	-
	1628 ~ 1698	dB	33	38	-
	1930 ~ 1995	dB	31	36	-
	2110 ~ 2170	dB	30	35	-
	2400 ~ 2690	dB	27	32	-
	3256 ~ 3396	dB	26	31	-
	3396 ~ 3800	dB	24	29	-
	4070 ~ 4245	dB	20	25	-
4884 ~ 5950	dB	8	13	-	
Termination Impedance : TX / ANTENNA			50Ω //15[nH] /50Ω // 10[nH]		

ANTENNA → RX					
Insertion Loss	859.25 ~ 893.75	dB	-	2.4	3.5
Inband Ripple	859.25 ~ 893.75	dB	-	1.2	2.5
VSWR	859.25 ~ 893.75	-	-	2.0	2.5
Absolute Attenuation	10 ~ 447	dB	40	68	-
	814.25 ~ 848.75	dB	45	57	-
	849 ~ 854	dB	3	15	-
	909 ~ 979	dB	15	23	-
	1427 ~ 1447	dB	40	68	-
	1710 ~ 1785	dB	50	60	-
	1850 ~ 1915	dB	50	59	-
	1920 ~ 1980	dB	40	59	-
	2400 ~ 2500	dB	40	57	-
	2467 ~ 2494	dB	50	57	-
	2577 ~ 2682	dB	40	56	-
4900 ~ 5950	dB	30	45	-	
Termination Impedance : ANTENNA / RX			50Ω // 10[nH] /50Ω // 40 [nH]		
TX → RX					
Isolation between Rx and Tx	814.25 ~ 848.75	dB	55	59	-
	859.25 ~ 893.75	dB	51	55	-

6-2-2. TEST FIXTURE

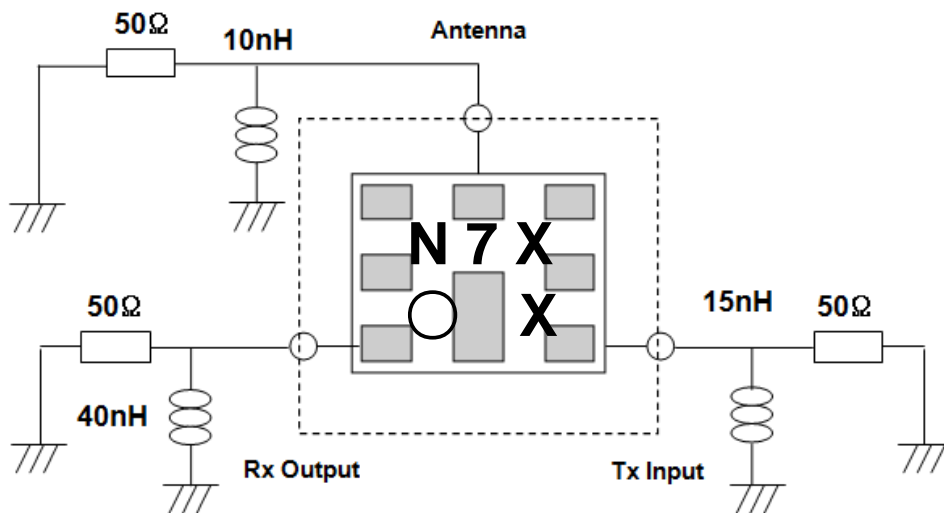

[X-Ray Top View]



6-2-3.  
GRAPH

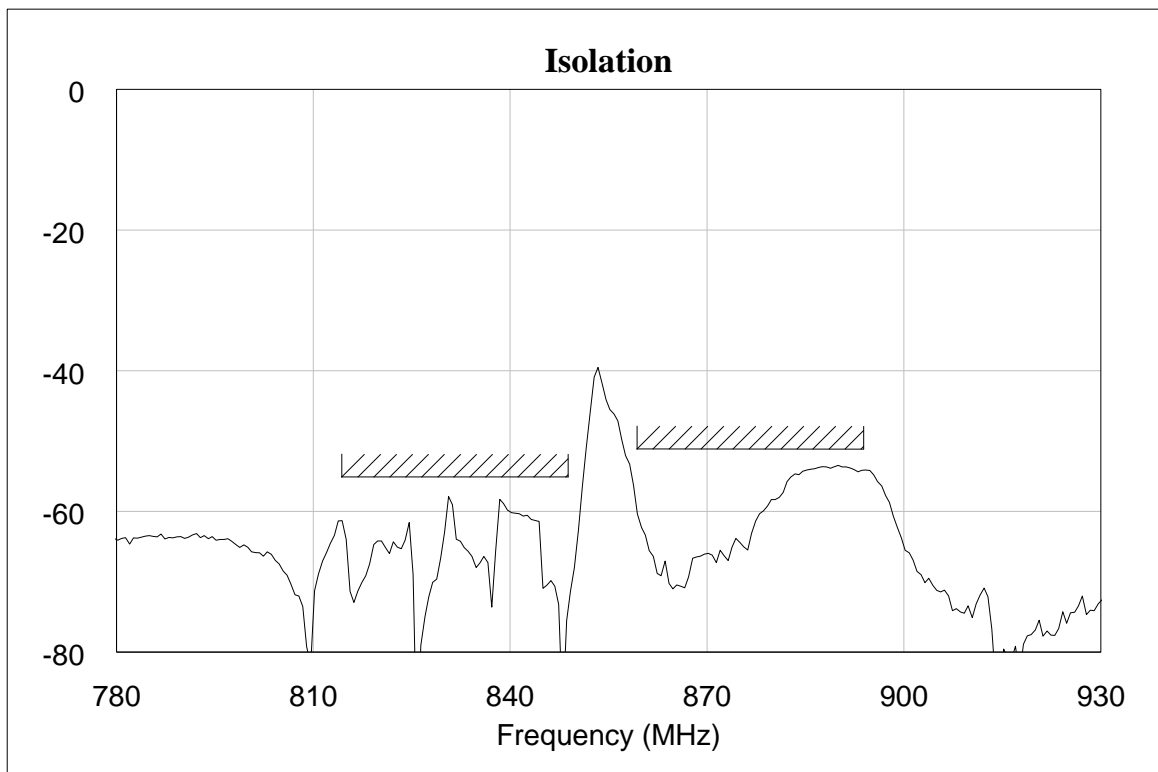
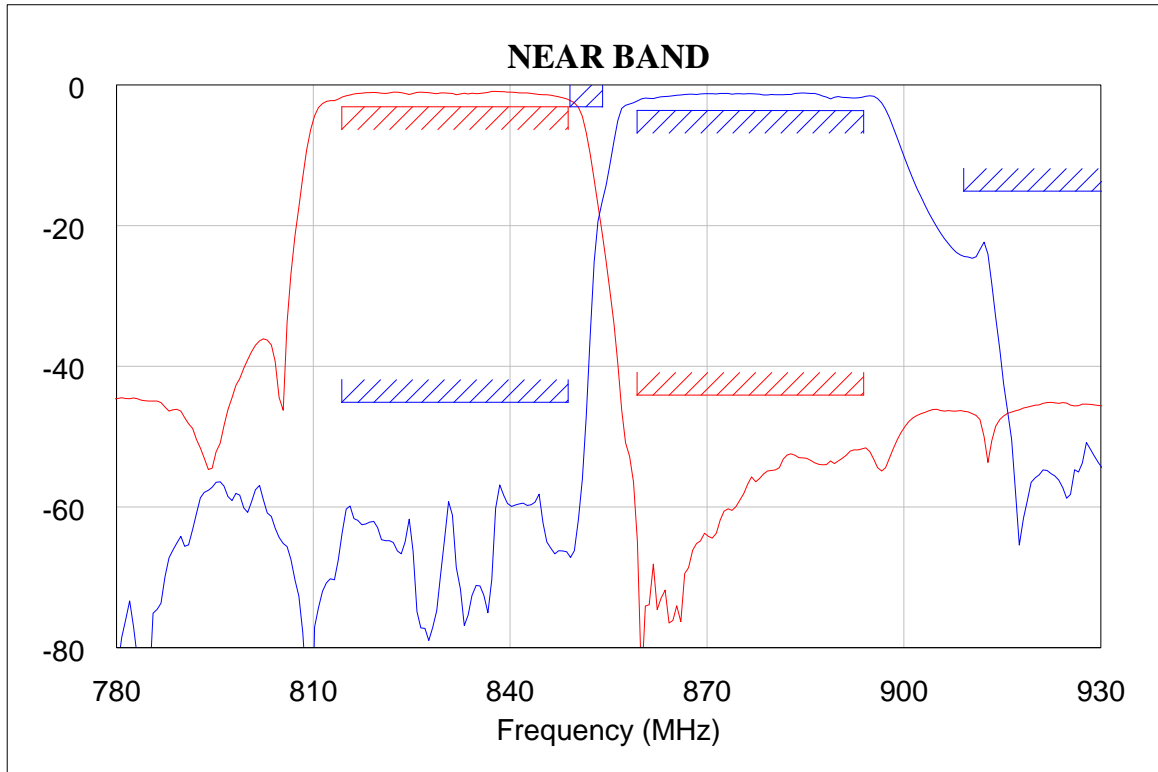

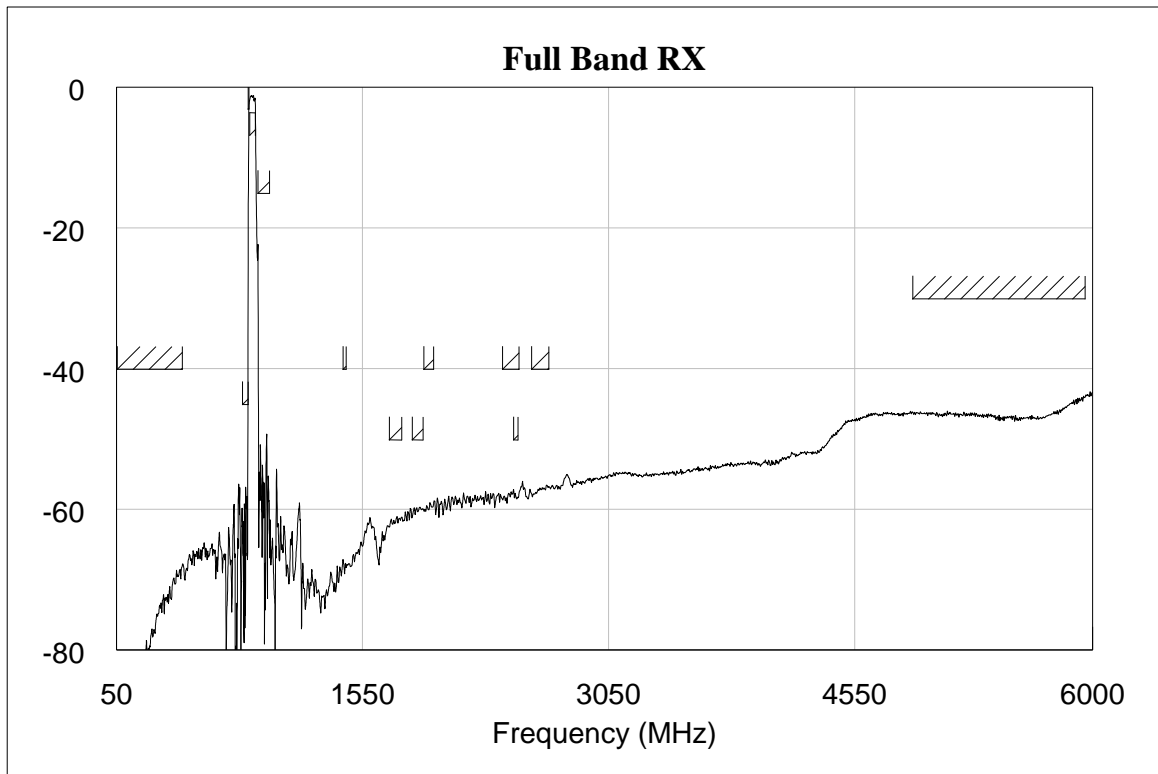
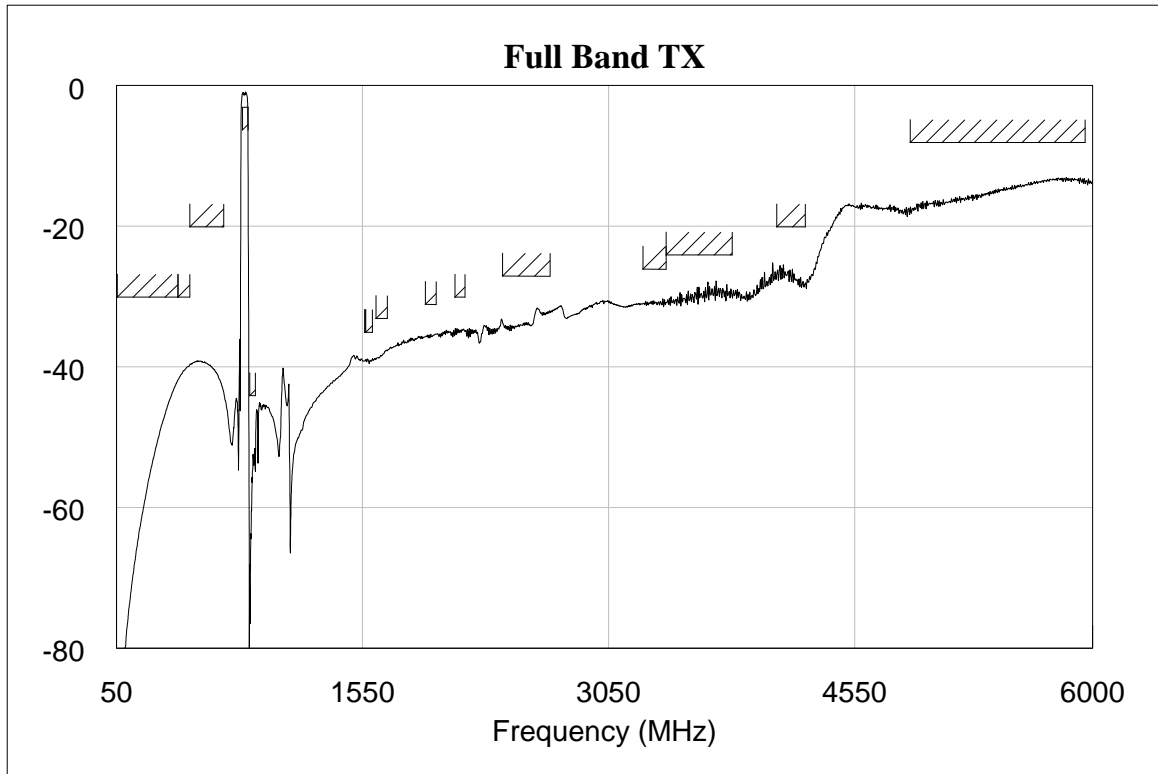

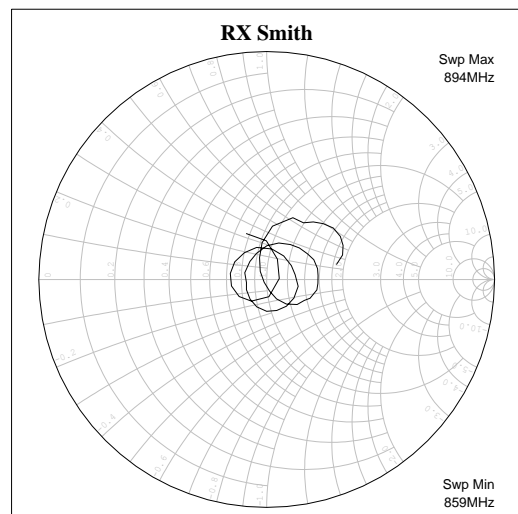
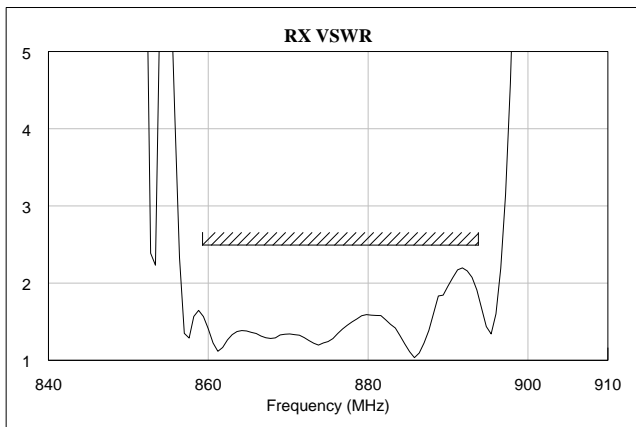
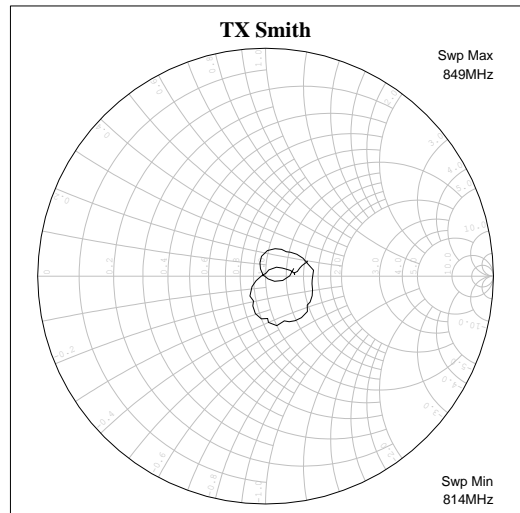
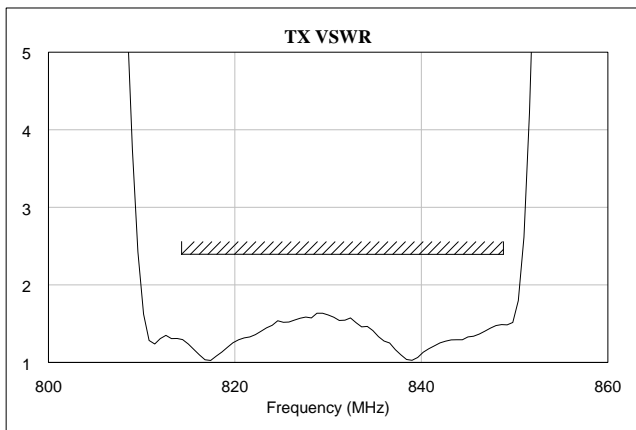
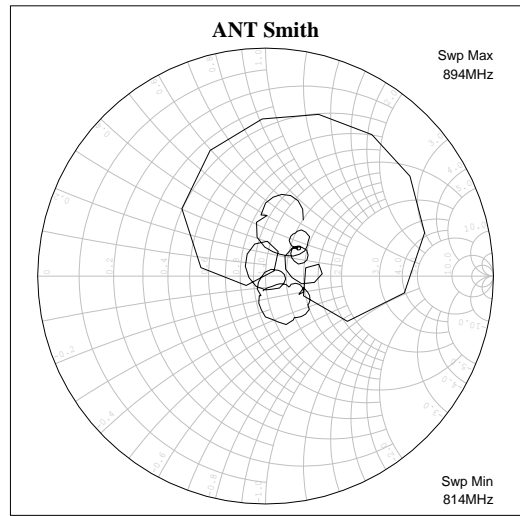
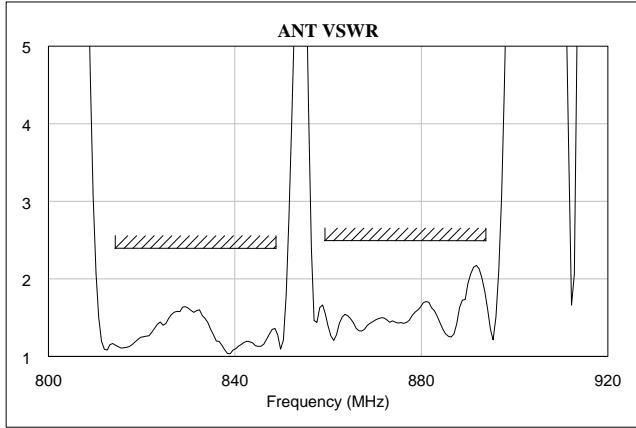

7. RELIABILITY

7-1. ENGINEERING SAMPLE FLOW CHART

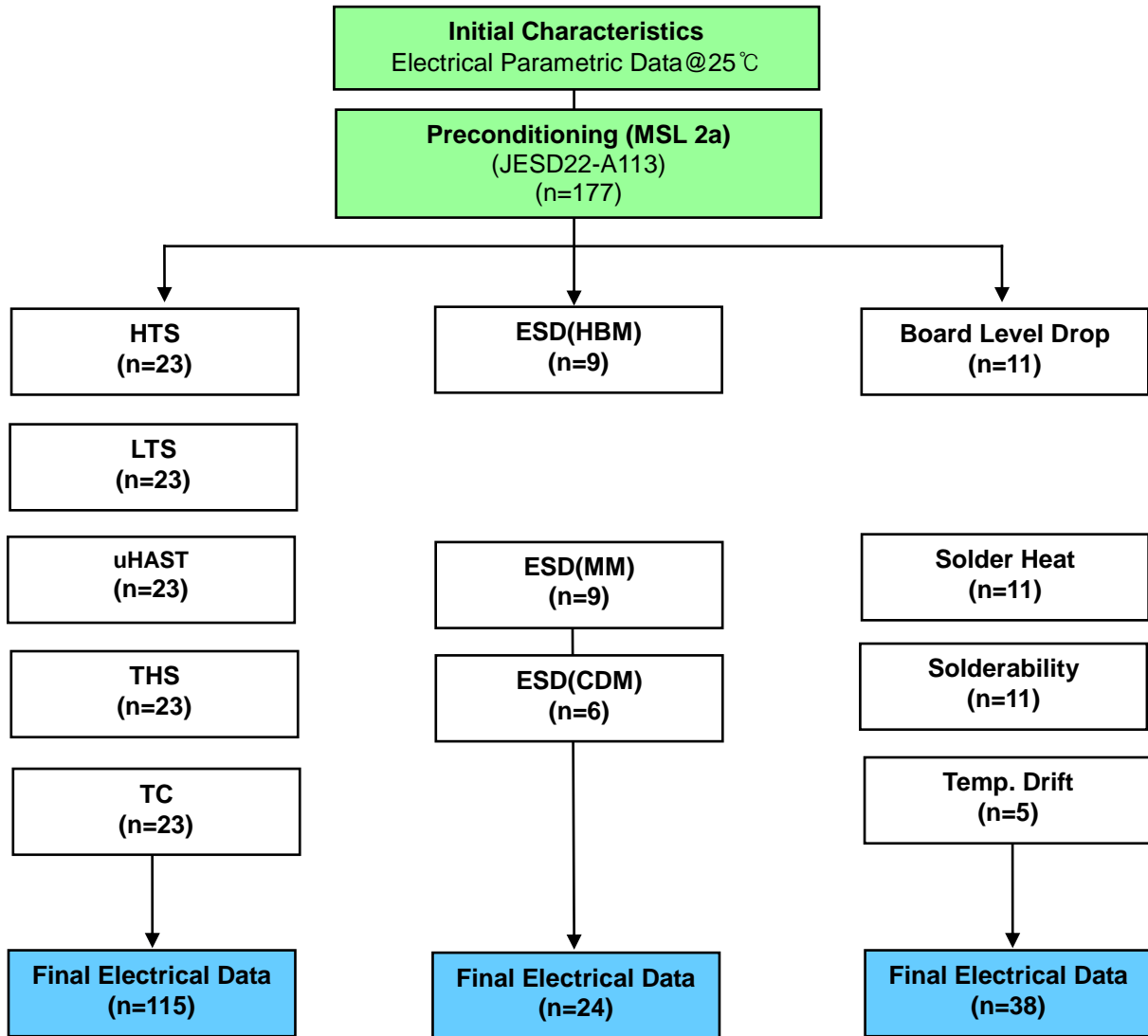

**7-2. TEST ITEM & CONDITION**

CATEGORY	TEST ITEM	TEST CONDITION	REMARK
	Preconditioning	Bake + Soak(MSL or above) + 3X Reflow duration ( Soak 60°C 60% 120HR)	JESD22-A113



TEST ITEM	REMARK	TEST CONDITION	Duration
HTS (High Temperature Storage)	JESD22-A103	condition A +125(-10/+0)°C	1000hr
LTS (Low Temperature Storage)	JESD22-A119	condition A -40(-10/+0)°C	1000hr
uHAST (Unbiased HAST)	JESD22-A118	condition A 130±2°C, 85±5%, 33.3psi	96hr
THS (Temperature Humidity Storage)	JESD22-A101	85±2°C, 85±5% RH	1000hr
TC (Temperature Cycle)	JESD22-A104	condition B (-55°C ⇄ +125°C) Soak mode 4 (30min)	500cycle
ESD(HBM)	JESD22-A114	200V, 250V, 300V	All pin 1sec 1time
ESD(MM)	JESD22-A115	100V 150V 200V	All pin 1sec 1time
ESD(CDM)	JESD22-C101	1.0KV, 1.2KV	All pin 1sec 1time
Board Level Drop Test	-	120 cm, 152 cm	12times 19times
Solder Heat Resistance	JESD22-B106C	260°C Solder Pore Dipping	10sec
Solderability	JESD22-B102E	235°C Solder Pore Dipping	3sec
Temp Drift		-40°C => 25°C => 125°C	Per condition 2HR

### 8. REFLOW CONDITION

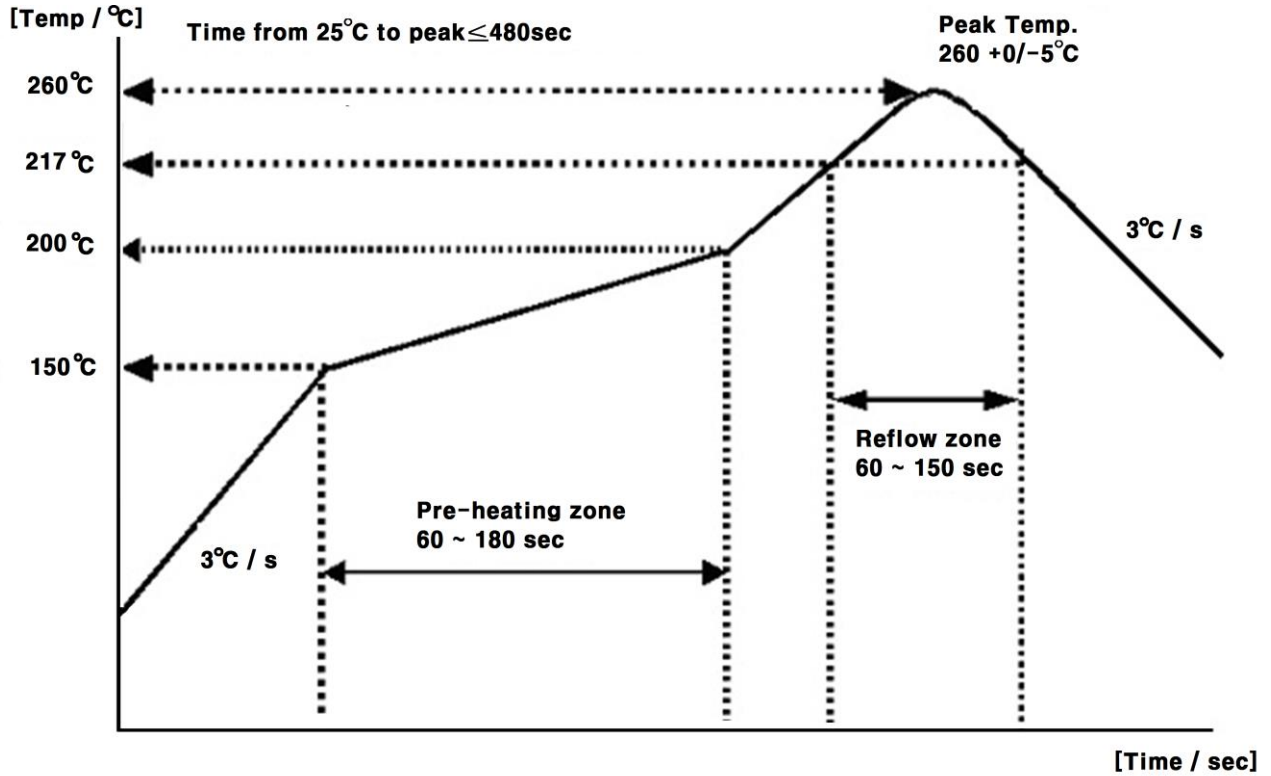

### 9. RECOMMENDED PCB DIMENSIONS

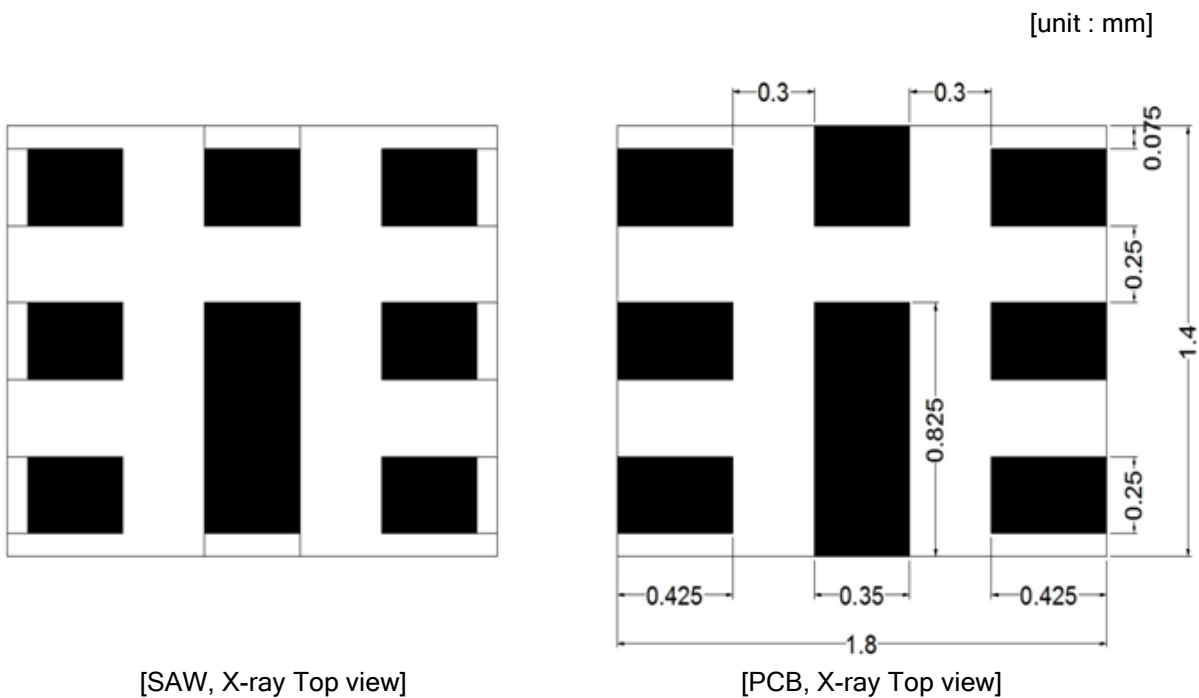

## 10. CAUTION

Moisture Sensitivity Device Caution (MSL LEVEL=2a)

1. Calculated shelf life in sealed bag : 12 month at < 40℃ and < 90% relative Humidity(RH)
  2. Peak package body temperature : **260℃**
  3. After bag is opened, devices that will be subjected to reflow solder or other high temperature process must be
    - (a) Mounted within : 672 hours of factory conditions ≤30℃/60% RH, or
    - (b) Stored per J-STD-033
  4. Device require bake, before mounting, if :
    - (a) Humidity Indicator Card reads > 60% when read at 23±5℃
    - (b) 3(a) or 3(b) are not met
  5. If baking is required, refer to IPC/JEDEC J-STD-033 for bake procedure
- Note : Level and body temperature defined by IPC/JEDEC J-STD-020

Aluminum Pack (310mmX370mm)



HIC(Humidity Indication Card)

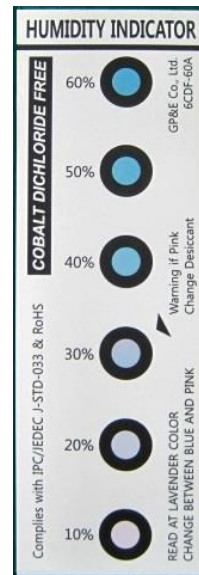

10 to 60% RH

### 11. PACKING

#### 11-1. DIMENSIONS

- Carrier Tape

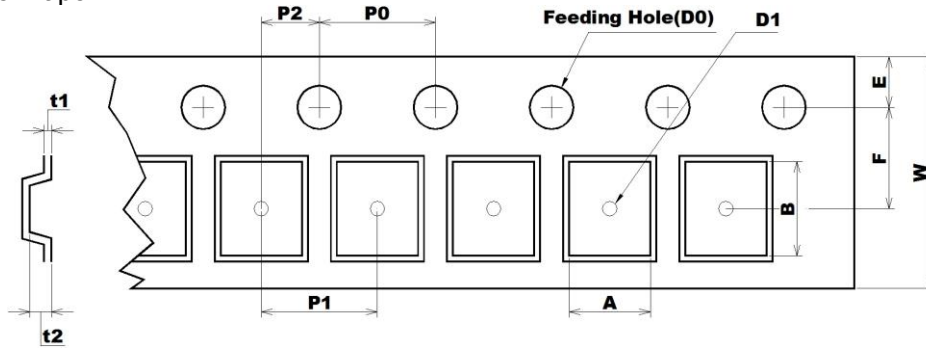

[Unit: mm]

A	B	D0	D1	E	F	P0	P1	P2	t1	t2	W
1.60	2.00	Ø1.55	Ø1.00	1.75	3.50	4.00	4.00	2.00	0.25	0.80	8.00
0.05	0.05	0.05	MIN	0.10	0.05	0.10	0.10	0.05	0.05	0.05	0.10
-0.05	-0.05	-0.05	-	-0.10	-0.05	-0.10	-0.10	-0.05	-0.05	-0.05	-0.10

- Reel

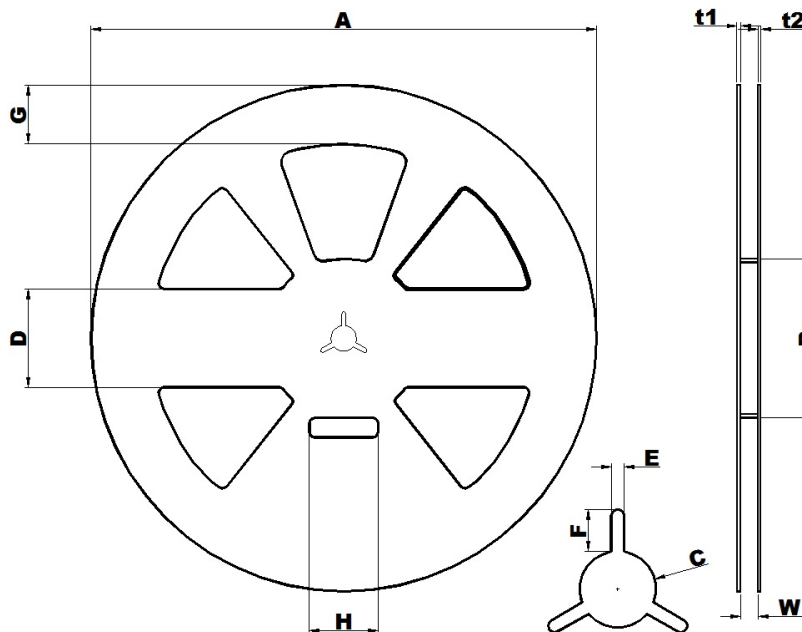

[Unit: mm]

A	B	C	D	E	F	G	H	t1	t2	W
Ø258.0	Ø81.0	Ø13.0	50.0	2.2	7.0	30.0	35.0	1.8	1.5	9.0
+1.0	+1.0	+0.5	+0.8	+0.3	+0.5	+0.8	+1.0	+0.5	+0.5	+1.0
-0.5	-1.0	-0.5	-0.8	-0.3	-0.5	-0.8	-1.0	-0.5	-0.5	-0.5

- The product shall be packed properly not to damaged during transportation and storage.



11-2. REELING QUANTITY

10 inch reel : 8,000 pcs/reel

11-3. TAPING STRUCTURE

11-3-1. The tape shall be wound around the reel in direction shown below.

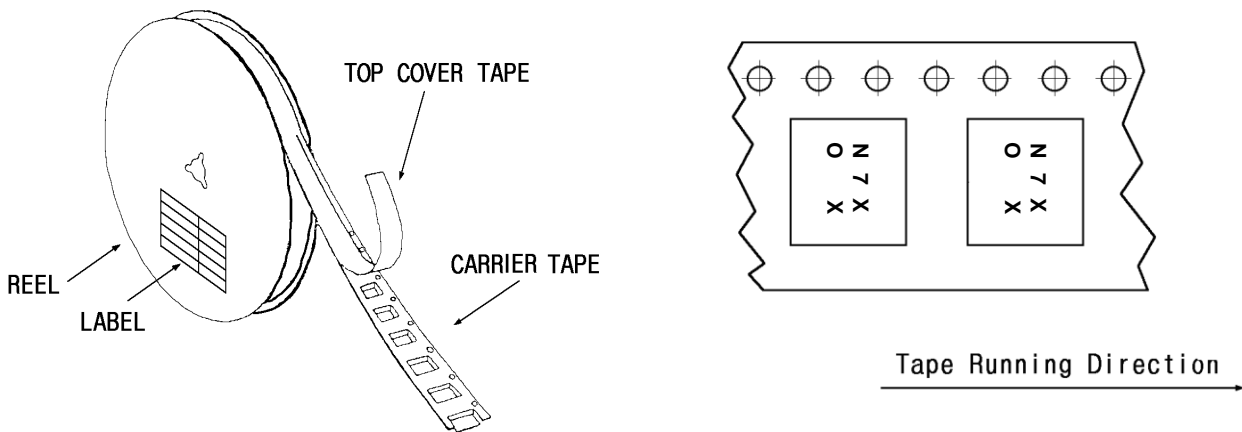

11-3-2. BARCODE LABEL



①	MODEL NAME BARCODE
②	Model Name
③	Reel number
④	Quantity / Marking

1-3-3. Leader part and vacant position specifications.

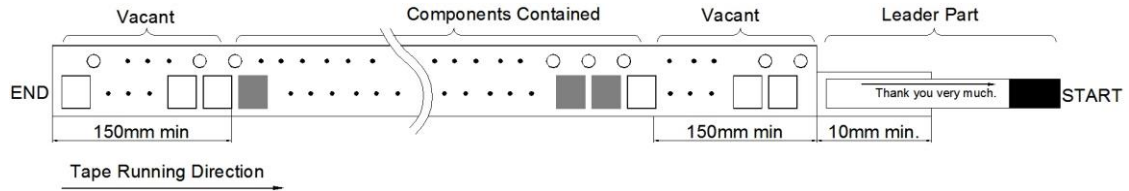

11-4. INNER BOX(Reel Packing) STRUCTURE

Material: Polycarbonate



Material : Polyethylene + Aluminium  
Size : 310×370mm<sup>2</sup>

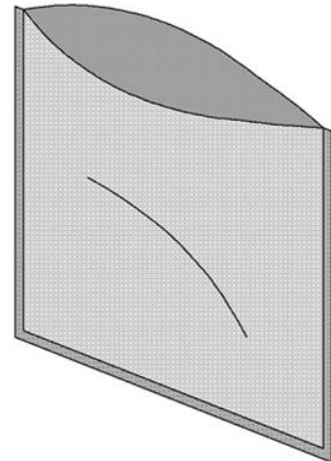

Material : Paper  
Size: (D)290×(W)290×(H)42mm<sup>3</sup>

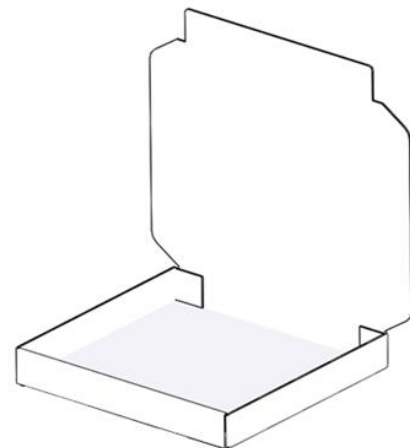

11-5. OUTER BOX STRUCTURE

Material : Paper

TYPE	SIZE(mm)			Inner Box #
	a	b	c	
A	300	270	300	6 boxes

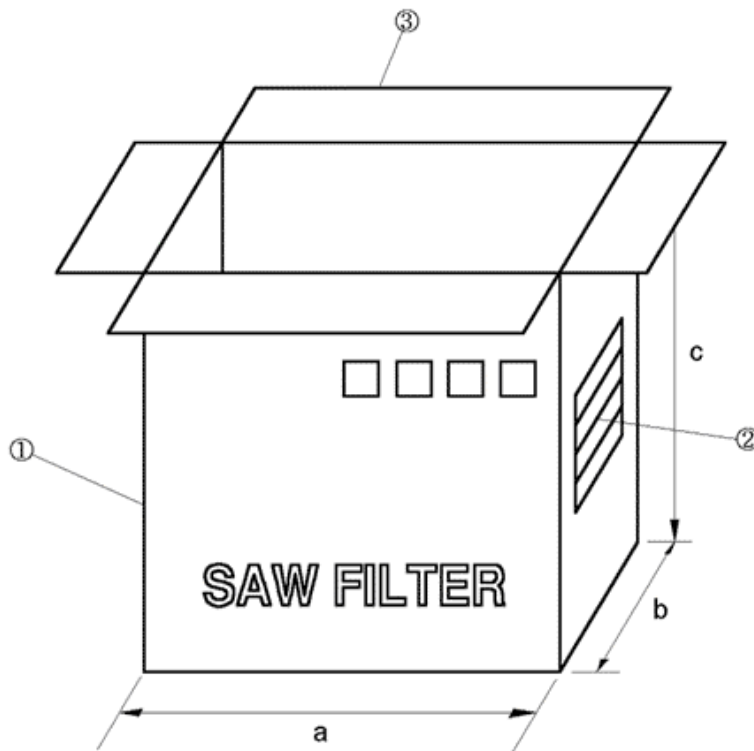

SIDE ①

SIDE ②

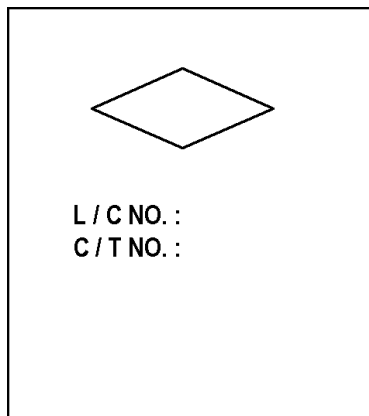

MODEL	
Q'TY	EA
USER	
DATE	. .

- SIDE is the same as front side.

## 12. TAPE SPECIFICATIONS

12-1. Tensile Strength of Carrier Tape: 4.4N/mm width

12-2. Top Cover Tape Adhesion (See the below figure)

- pull of angle: 0~15 degree
- speed: 300mm/min.
- force: 20~70g

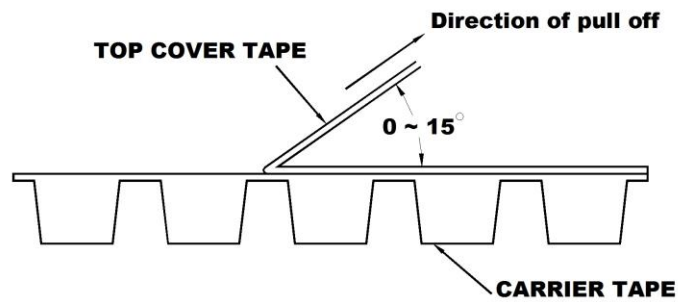

### 13. RoHS DATA

#### 13-1. RAW MATERIAL(EPOXY)



**Test Report** No. F690101/LF-CTSAYAA19-48090

Issued Date : 2019. 08. 02

Page 1 of 8

**NAGASE KOREA**

Danam Bldg 23F, 10 Sowol-ro  
Jung-gu, Seoul  
Korea

The following sample(s) was/were submitted and identified by/on behalf of the client as:-

**SGS File No.** : AYAA19-48090  
**Product Name** : EPOXY SHEET A2042  
**Item No./Part No.** : N/A  
**Received Date** : 2019. 07. 26  
**Test Period** : 2019. 07. 26 to 2019. 08. 02  
**Test Results** : For further details, please refer to following page(s)

SGS Korea Co., Ltd.



Tommy Oh / Chemical Lab Mgr

This document is issued by the Company subject to its General Conditions of Service printed overleaf, available on request or accessible at <http://www.sgs.com/en/terms-and-conditions.aspx> and, for electronic documents, subject to Terms and Conditions for Electronic Documents at [www.sgs.com/terms\\_e-document.htm](http://www.sgs.com/terms_e-document.htm) <[http://www.sgs.com/terms\\_e-document.htm](http://www.sgs.com/terms_e-document.htm)>. Attention is drawn to the limitation of liability, indemnification and jurisdiction issues defined therein. Any holder of this document is advised that information contained hereon reflects the Company's findings at the time of its intervention only and within the limits of Client's instructions, if any. The Company's sole responsibility is to its Client and this document does not exonerate parties to a transaction from exercising all their rights and obligations under the transaction documents. This document cannot be reproduced except in full, without prior written approval of the Company. Any unauthorized alteration, forgery or falsification of the content or appearance of this document is unlawful and offenders may be prosecuted to the fullest extent of the law. Unless otherwise indicated the results shown in this test report refer only to the sample(s).

F401 000005



SGS Korea Co., Ltd.

322, The O valley, 76, LS-ro, Dongan-gu, Anyang-si, Gyeonggi-do, Korea 14117  
t +82 (0)31 4608 000 f +82 (0)31 4608 059 <http://www.sgskorea.kr>

Member of the SGS Group (Société Générale de Surveillance)



**Test Report** No. F690101/LF-CTSAYAA19-48090

Issued Date : 2019. 08. 02

Page 2 of 8

**Sample No.** : AYAA19-48090.001  
**Sample Description** : EPOXY SHEET A2042  
**Item No./Part No.** : N/A  
**Materials** : Epoxy Resin

**Heavy Metals**

Test Items	Unit	Test Method	MDL	Results
Cadmium (Cd)	mg/kg	With reference to IEC 62321-5:2013 (Determination of Cadmium by ICP-OES)	0.5	N.D.
Lead (Pb)	mg/kg	With reference to IEC 62321-5:2013 (Determination of Lead by ICP-OES)	5	N.D.
Mercury (Hg)	mg/kg	With reference to IEC 62321-4:2013 (Determination of Mercury by ICP-OES)	2	N.D.
Hexavalent Chromium (Cr VI)*	mg/kg	With reference to IEC 62321-7-2:2017, determination of Hexavalent Chromium by Colorimetric Method using UV-Vis and Microwave system/or with reference to IEC 62321-5:2013, determination of Chromium by ICP-OES.	8	N.D.
Antimony (Sb)	mg/kg	With reference to EPA 3052(1996), US EPA 6010B(1996), ICP	10	N.D.
Tin (Sn)	mg/kg	With reference to EPA 3052(1996), US EPA 6010B(1996), ICP	10	N.D.

**Flame Retardants-PBBs/PBDEs**

Test Items	Unit	Test Method	MDL	Results
Monobromobiphenyl	mg/kg	With reference to IEC 62321-6:2015 (Determination of PBBs and PBDEs by GC-MS)	5	N.D.
Dibromobiphenyl	mg/kg	With reference to IEC 62321-6:2015 (Determination of PBBs and PBDEs by GC-MS)	5	N.D.
Tribromobiphenyl	mg/kg	With reference to IEC 62321-6:2015 (Determination of PBBs and PBDEs by GC-MS)	5	N.D.
Tetrabromobiphenyl	mg/kg	With reference to IEC 62321-6:2015 (Determination of PBBs and PBDEs by GC-MS)	5	N.D.
Pentabromobiphenyl	mg/kg	With reference to IEC 62321-6:2015 (Determination of PBBs and PBDEs by GC-MS)	5	N.D.
Hexabromobiphenyl	mg/kg	With reference to IEC 62321-6:2015 (Determination of PBBs and PBDEs by GC-MS)	5	N.D.
Heptabromobiphenyl	mg/kg	With reference to IEC 62321-6:2015 (Determination of PBBs and PBDEs by GC-MS)	5	N.D.
Octabromobiphenyl	mg/kg	With reference to IEC 62321-6:2015 (Determination of PBBs and PBDEs by GC-MS)	5	N.D.
Nonabromobiphenyl	mg/kg	With reference to IEC 62321-6:2015 (Determination of PBBs and PBDEs by GC-MS)	5	N.D.
Decabromobiphenyl	mg/kg	With reference to IEC 62321-6:2015 (Determination of PBBs and PBDEs by GC-MS)	5	N.D.

This document is issued by the Company subject to its General Conditions of Service printed overleaf, available on request or accessible at <http://www.sgs.com/en/terms-and-conditions.aspx> and, for electronic format documents, subject to Terms and Conditions for Electronic Documents at [www.sgs.com/terms-e-document.htm](http://www.sgs.com/terms-e-document.htm) <<http://www.sgs.com/terms-e-document.htm>>. Attention is drawn to the limitation of liability, indemnification and jurisdiction issues defined therein. Any holder of this document is advised that information contained hereon reflects the Company's findings at the time of its intervention only and within the limits of Client's instructions, if any. The Company's sole responsibility is to its Client and this document does not exonerate parties to a transaction from exercising all their rights and obligations under the transaction documents. This document cannot be reproduced except in full, without prior written approval of the Company. Any unauthorized alteration, forgery or falsification of the content or appearance of this document is unlawful and offenders may be prosecuted to the fullest extent of the law. Unless otherwise stated the results shown in this test report refer only to the sample(s).



**Test Report** No. F690101/LF-CTSAYAA19-48090

Issued Date : 2019. 08. 02

Page 3 of 8

**Sample No.** : AYAA19-48090.001  
**Sample Description** : EPOXY SHEET A2042  
**Item No./Part No.** : N/A  
**Materials** : Epoxy Resin

**Flame Retardants-PBBs/PBDEs**

Test Items	Unit	Test Method	MDL	Results
Monobromodiphenyl ether	mg/kg	With reference to IEC 62321-6:2015 (Determination of PBBs and PBDEs by GC-MS)	5	N.D.
Dibromodiphenyl ether	mg/kg	With reference to IEC 62321-6:2015 (Determination of PBBs and PBDEs by GC-MS)	5	N.D.
Tribromodiphenyl ether	mg/kg	With reference to IEC 62321-6:2015 (Determination of PBBs and PBDEs by GC-MS)	5	N.D.
Tetrabromodiphenyl ether	mg/kg	With reference to IEC 62321-6:2015 (Determination of PBBs and PBDEs by GC-MS)	5	N.D.
Pentabromodiphenyl ether	mg/kg	With reference to IEC 62321-6:2015 (Determination of PBBs and PBDEs by GC-MS)	5	N.D.
Hexabromodiphenyl ether	mg/kg	With reference to IEC 62321-6:2015 (Determination of PBBs and PBDEs by GC-MS)	5	N.D.
Heptabromodiphenyl ether	mg/kg	With reference to IEC 62321-6:2015 (Determination of PBBs and PBDEs by GC-MS)	5	N.D.
Octabromodiphenyl ether	mg/kg	With reference to IEC 62321-6:2015 (Determination of PBBs and PBDEs by GC-MS)	5	N.D.
Nonabromodiphenyl ether	mg/kg	With reference to IEC 62321-6:2015 (Determination of PBBs and PBDEs by GC-MS)	5	N.D.
Decabromodiphenyl ether	mg/kg	With reference to IEC 62321-6:2015 (Determination of PBBs and PBDEs by GC-MS)	5	N.D.

**Phthalates**

Test Items	Unit	Test Method	MDL	Results
Di-(2-ethylhexyl) phthalate (DEHP)	mg/kg	With reference to IEC 62321-8 ; 2017 , GC/MS	50	N.D.
Di-butyl phthalate (DBP)	mg/kg	With reference to IEC 62321-8 ; 2017 , GC/MS	50	N.D.
Benzyl butyl phthalate (BBP)	mg/kg	With reference to IEC 62321-8 ; 2017 , GC/MS	50	N.D.
Di-Isobutyl phthalate (DIBP)	mg/kg	With reference to IEC 62321-8 ; 2017 , GC/MS	50	N.D.

**Halogen Content**

Test Items	Unit	Test Method	MDL	Results
Bromine(Br)	mg/kg	With reference to EN 14582:2016, IC	30	N.D.
Chlorine(Cl)	mg/kg	With reference to EN 14582:2016, IC	30	N.D.
Fluorine(F)	mg/kg	With reference to EN 14582:2016, IC	30	N.D.
Iodine(I)	mg/kg	With reference to EN 14582:2016, IC	50	N.D.

This document is issued by the Company subject to its General Conditions of Service printed overleaf, available on request or accessible at <http://www.sgs.com/terms-and-conditions.aspx> and, for electronic format documents, subject to Terms and Conditions for Electronic Documents at [www.sgs.com/terms-e-document.htm](http://www.sgs.com/terms-e-document.htm) <<http://www.sgs.com/terms-e-document.htm>>. Attention is drawn to the limitation of liability, indemnification and jurisdiction issues defined therein. Any holder of this document is advised that information contained hereon reflects the Company's findings at the time of its intervention only and within the limits of Client's instructions, if any. The Company's sole responsibility is to its Client and this document does not exonerate parties to a transaction from exercising all their rights and obligations under the transaction documents. This document cannot be reproduced except in full, without prior written approval of the Company. Any unauthorized alteration, forgery or falsification of the content or appearance of this document is unlawful and offenders may be prosecuted to the fullest extent of the law. Unless otherwise stated the results shown in this test report refer only to the sample(s).

F401 Version5

SGS Korea Co., Ltd.

322, The O valley, 76, LS-ro, Dongan-gu, Anyang-si, Gyeonggi-do, Korea 14117  
 T +82 (0)31 4608 000 F +82 (0)31 4608 059 <http://www.sgsgroup.kr>

Member of the SGS Group (Société Générale de Surveillance)



**Test Report** No. F690101/LF-CTSAYAA19-48090

Issued Date : 2019. 08. 02

Page 4 of 8

- NOTE:
- (1) N.D. = Not detected.(<MDL)
  - (2) mg/kg = ppm
  - (3) MDL = Method Detection Limit
  - (4) - = No regulation
  - (5) Negative = Undetectable / Positive = Detectable
  - (6) \*\* = Qualitative analysis (No Unit)
  - (7) \* = a. The result of Hexavalent Chromium (Cr(VI)) is "ND" as the result of Chromium (Cr) is "ND", and confirmation test of Hexavalent Chromium (Cr(VI)) is not required.  
 b. If the Chromium (Cr) content is greater than the MDL of Hexavalent Chromium (Cr(VI)), confirmation test of Hexavalent Chromium (Cr(VI)) is required.

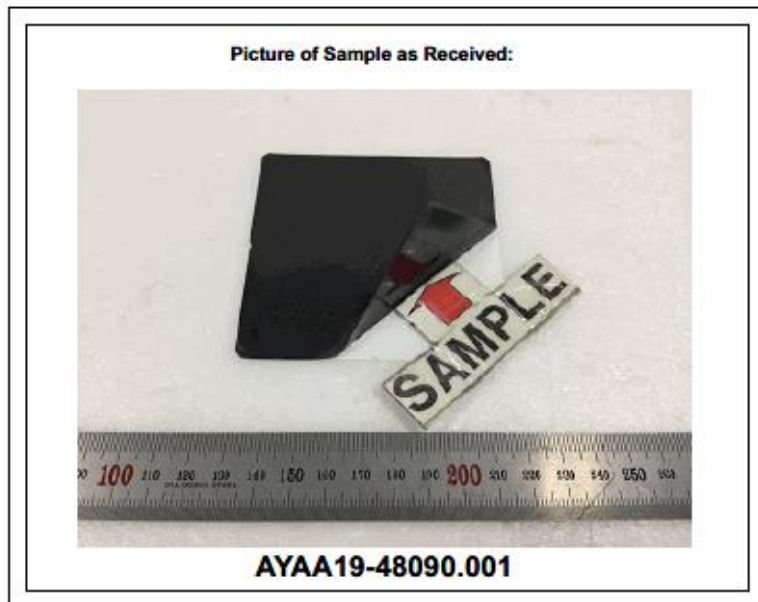

This document is issued by the Company subject to its General Conditions of Service printed overleaf, available on request or accessible at <http://www.sgs.com/en/terms-and-conditions.aspx> and, for electronic format documents, subject to Terms and Conditions for Electronic Documents at [www.sgs.com/terms\\_e-document.htm](http://www.sgs.com/terms_e-document.htm) <[http://www.sgs.com/terms\\_e-document.htm](http://www.sgs.com/terms_e-document.htm)>. Attention is drawn to the limitation of liability, indemnification and jurisdiction issues defined therein. Any holder of this document is advised that information contained herein reflects the Company's findings at the time of its intervention only and within the limits of Client's instructions, if any. The Company's sole responsibility is to its Client and this document does not exonerate parties to a transaction from exercising all their rights and obligations under the transaction documents. This document cannot be reproduced except in full, without prior written approval of the Company. Any unauthorized alteration, forgery or falsification of the content or appearance of this document is unlawful and offenders may be prosecuted to the fullest extent of the law. Unless otherwise stated the results shown in this test report refer only to the sample(s).





Test Report No. F690101/LF-CTSAYAA19-48090

Issued Date : 2019. 08. 02

Page 5 of 8

Testing Flow Chart for RoHS: Cd/Pb/Hg/Cr<sup>6+</sup> /PBBs&PBDEs Testing

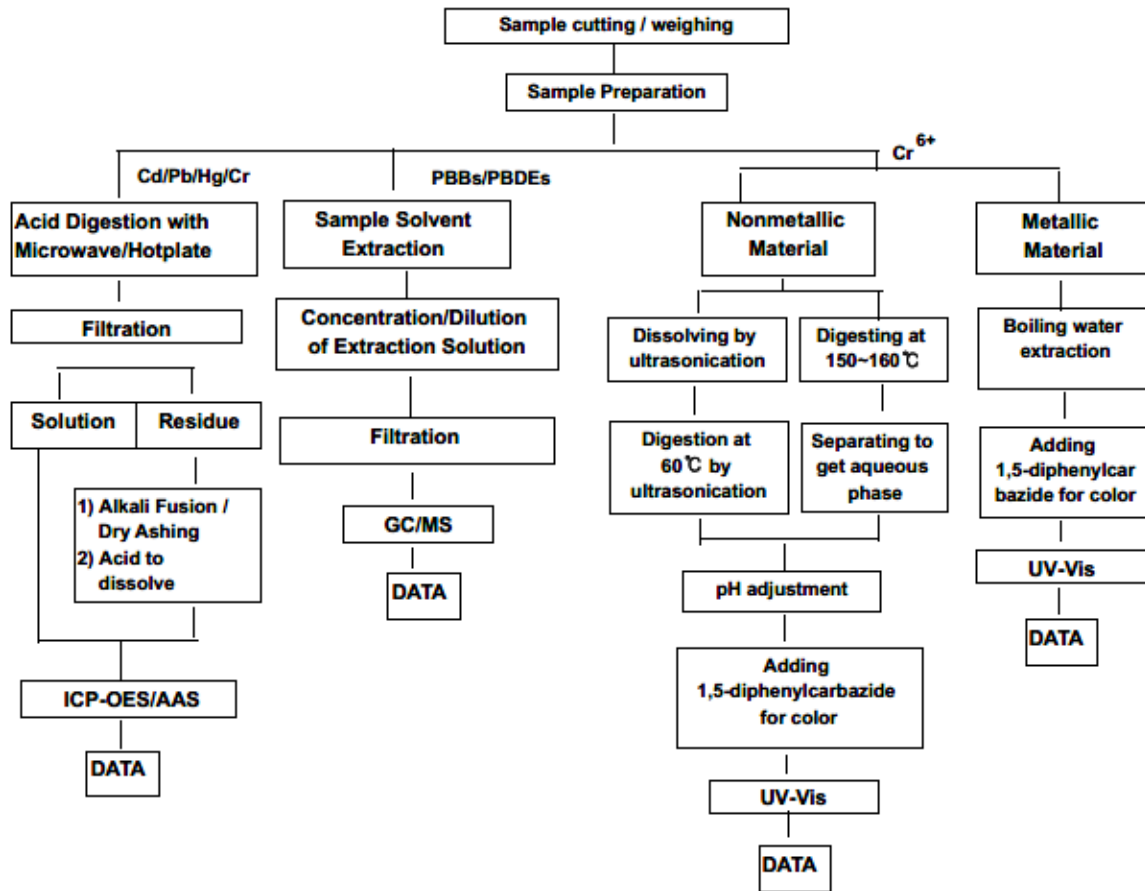

The samples were dissolved totally at the acid digestion step of the above flow chart for Cd,Pb,Hg

Section Chief : Minkyu Park

This document is issued by the Company subject to its General Conditions of Service printed overleaf, available on request or accessible at <http://www.sgs.com/terms-and-conditions.aspx> and, for electronic format documents, subject to Terms and Conditions for Electronic Documents at [www.sgs.com/terms\\_e-document.htm](http://www.sgs.com/terms_e-document.htm) and [http://www.sgs.com/terms\\_e-document.htm](http://www.sgs.com/terms_e-document.htm). Attention is drawn to the limitation of liability, indemnification and jurisdiction issues defined therein. Any holder of this document is advised that information contained herein reflects the Company's findings at the time of its intervention only and within the limits of Client's instructions, if any. The Company's sole responsibility is to its Client and this document does not exonerate parties to a transaction from exercising all their rights and obligations under the transaction documents. This document cannot be reproduced except in full, without prior written approval of the Company. Any unauthorized alteration, forgery or falsification of the content or appearance of this document is unlawful and offenders may be prosecuted to the fullest extent of the law. Unless otherwise stated the results shown in this test report refer only to the sample(s).



Test Report No. F690101/LF-CTSAYAA19-48090

Issued Date : 2019. 08. 02

Page 6 of 8

Flow Chart for Inorganic Elements Testing

Inorganic Elements

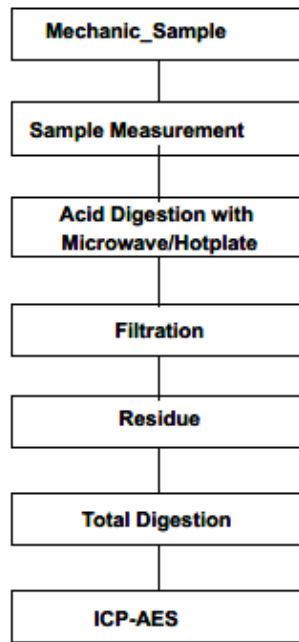

DATA

Major Inorganic Heavy Metals	Antimony(Sb) , Beryllium(Be) , Phosphorus(P) , Arsenic(As) etc.
---------------------------------	--

This document is issued by the Company subject to its General Conditions of Service printed overleaf, available on request or accessible at <http://www.sgs.com/en/terms-and-conditions.aspx> and, for electronic format documents, subject to Terms and Conditions for Electronic Documents at [www.sgs.com/terms\\_e-document.htm](http://www.sgs.com/terms_e-document.htm) and [http://www.sgs.com/terms\\_e-document.htm](http://www.sgs.com/terms_e-document.htm). Attention is drawn to the limitation of liability, indemnification and jurisdiction issues defined therein. Any holder of this document is advised that information contained hereon reflects the Company's findings at the time of its intervention only and within the limits of Client's instructions, if any. The Company's sole responsibility is to its Client and this document does not exonerate parties to a transaction from exercising all their rights and obligations under the transaction documents. This document cannot be reproduced except in full, without prior written approval of the Company. Any unauthorized alteration, forgery or falsification of the content or appearance of this document is unlawful and offenders may be prosecuted to the fullest extent of the law. Unless otherwise stated the results shown in this test report refer only to the sample(s).

F401 Version5

SGS Korea Co., Ltd.

322, The O valley, 76, LS-ro, Dongan-gu, Anyang-si, Gyeonggi-do, Korea 14117  
t +82 (0)31 4808 000 f +82 (0)31 4808 050 <http://www.sgskorea.kr>

Member of the SGS Group (Société Générale de Surveillance)



Test Report No. F690101/LF-CTSAYAA19-48090

Issued Date : 2019. 08. 02

Page 7 of 8

Flow Chart for Halogen Test

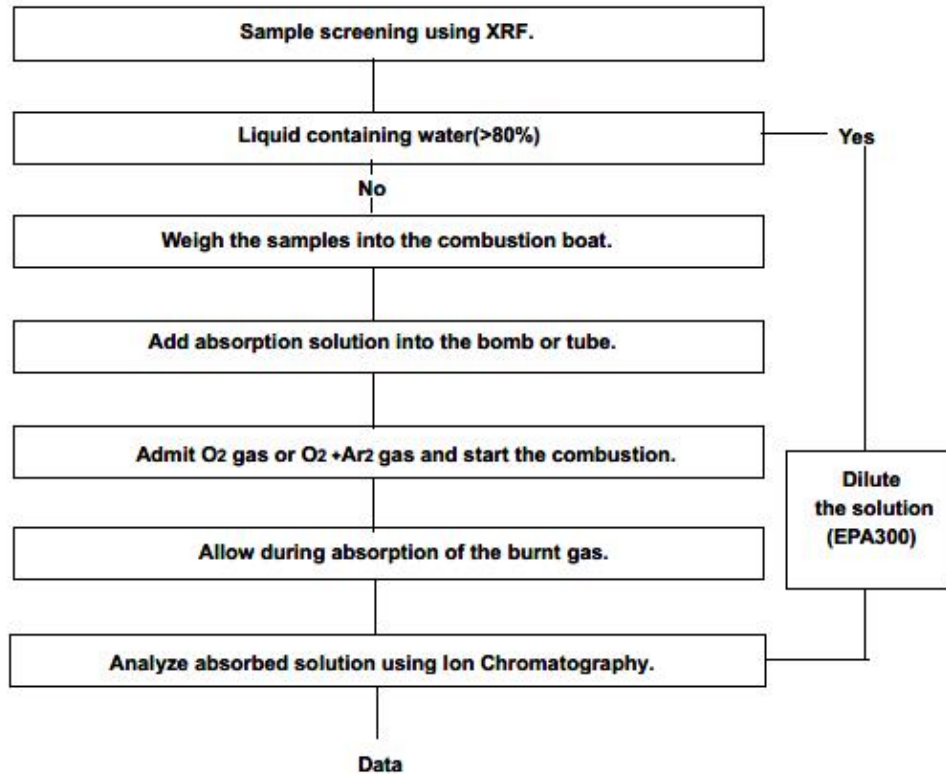

This document is issued by the Company subject to its General Conditions of Service printed overleaf, available on request or accessible at <http://www.sgs.com/en/terms-and-conditions.aspx> and, for electronic format documents, subject to Terms and Conditions for Electronic Documents at [www.sgs.com/terms\\_e-document.htm](http://www.sgs.com/terms_e-document.htm) and [http://www.sgs.com/terms\\_e-document.htm](http://www.sgs.com/terms_e-document.htm). Attention is drawn to the limitation of liability, indemnification and jurisdiction issues defined therein. Any holder of this document is advised that information contained hereon reflects the Company's findings at the time of its intervention only and within the limits of Client's instructions, if any. The Company's sole responsibility is to its Client and this document does not exonerate parties to a transaction from exercising all their rights and obligations under the transaction documents. This document cannot be reproduced except in full, without prior written approval of the Company. Any unauthorized alteration, forgery or falsification of the content or appearance of this document is unlawful and offenders may be prosecuted to the fullest extent of the law. Unless otherwise stated the results shown in this test report refer only to the sample(s).

F401 Version5

SGS Korea Co.,Ltd.

322, The D valley, 76, LS-ro, Dongen-gu, Anyang-si, Gyeonggi-do, Korea 14117  
 T +82 (0)31 4608 000 F +82 (0)31 4608 050 <http://www.sgskorea.co.kr>

Member of the SGS Group (Société Générale de Surveillance)



Test Report No. F690101/LF-CTSAYAA19-48090

Issued Date : 2019. 08. 02

Page 8 of 8

Flow Chart for Phthalate Test

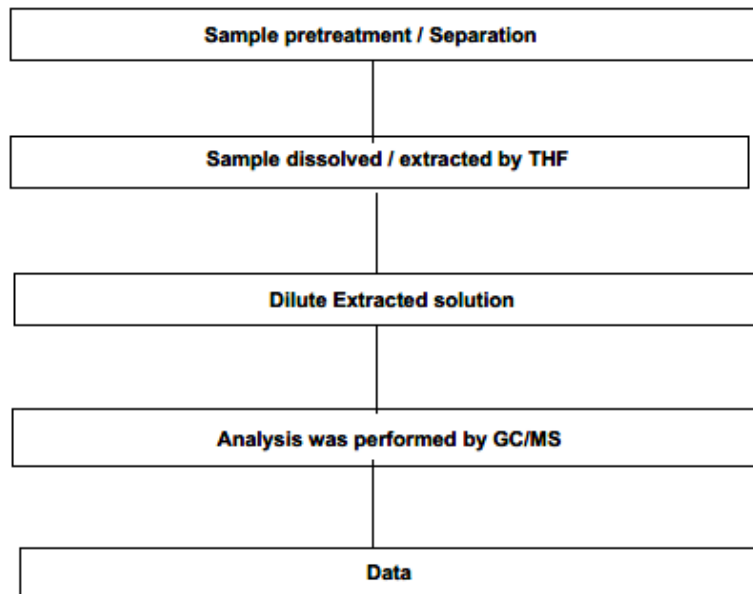

\*\*\* End of Report \*\*\*

This document is issued by the Company subject to its General Conditions of Service printed overleaf, available on request or accessible at <http://www.sgs.com/en/Terms-and-Conditions.aspx> and, for electronic format documents, subject to Terms and Conditions for Electronic Documents at [www.sgs.com/terms\\_e-document.htm](http://www.sgs.com/terms_e-document.htm) <[http://www.sgs.com/terms\\_e-document.htm](http://www.sgs.com/terms_e-document.htm)>. Attention is drawn to the limitation of liability, indemnification and jurisdiction issues defined therein. Any holder of this document is advised that information contained hereon reflects the Company's findings at the time of its intervention only and within the limits of Client's instructions, if any. The Company's sole responsibility is to its Client and this document does not exonerate parties to a transaction from exercising all their rights and obligations under the transaction documents. This document cannot be reproduced except in full, without prior written approval of the Company. Any unauthorized alteration, forgery or falsification of the content or appearance of this document is unlawful and offenders may be prosecuted to the fullest extent of the law. Unless otherwise stated the results shown in this test report refer only to the sample(s).

F401 Version5

SGS Korea Co., Ltd.

322, The G valley, 76, LS-ro, Dongan-gu, Anyang-si, Gyeonggi-do, Korea 14117  
t +82 (0)31 4608 000 f +82 (0)31 4608 050 <http://www.sgskorea.kr>

Member of the SGS Group (Société Générale de Surveillance)

13-2. RAW MATERIAL(PACKAGE)



TEST REPORT

REPORT NO. JP/2018/111201

DATE: January 11, 2019

PAGE: 1 OF 4

KYOCERA CORPORATION

1810 TAKI-CHO SATSUMASENDAI-SHI KAGOSHIMA JAPAN

THE FOLLOWING SAMPLE(S) WAS/WERE SUBMITTED AND IDENTIFIED BY/ON BEHALF OF THE CLIENT AS:

以下のサンプルは顧客により提供され、顧客に代わって確認を行いました:

SAMPLE DESCRIPTION : 1-01-4-19 KYOCERA: CERAMIC A440

CLIENT REF.NO :

SAMPLE RECEIVED : 2018/11/21

TESTING DATE : 2018/11/21 TO 2019/01/11

TEST REQUESTED : SELECTED TEST(S) AS REQUESTED BY CLIENT.  
分析項目 : 分析項目は顧客の要求によります。

TEST METHOD(S) : WITH REFERENCE TO LATEST EDITION OF IEC62321 FOR RoHS 6 SUBSTANCES.  
分析方法 : OTHER CHEMICALS WERE TESTED BY EACH APPROPRIATE METHOD.  
RoHS6物質の分析は最新版のIEC62321を参照しました。  
それ以外の化学物質についてはそれぞれに最適な方法で分析を行いました。

TEST RESULT(S) : PLEASE REFER TO THE NEXT PAGE(S).  
分析結果 : 以下のページをご参照願います。

大内 幸弘



Yukihiro Ouchi / Quality Manager  
SGS Japan Inc., Chemical Laboratory

This Test Report is issued by the Company under its General Conditions of Service printed overleaf or available on request and accessible at <http://www.sgs.com>. Attention is drawn to the limitation of liability, indemnification and jurisdiction issues defined therein. Unless otherwise stated the results shown in this Test Report refer only to the sample(s) tested. This Test Report cannot be reproduced except, in full, without prior approval of the Company. Any unauthorized alteration, forgery or falsification of the content or appearance of this test report is unlawful and offenders may be prosecuted to the fullest extent of the law.

JP

この検査報告書は裏面に記載された、もしくは<http://www.sgs.com>で入手可能なサービスに関する一般的な条件に引いて発行されます。それらに記載されている弊社の負うべき義務・補償の範囲及び消法等の項目をご注意ください。特に特に明記のない限り、この検査報告書に記載された結果は、検査した試料のみに限ります。この書面全体の複製以外には、弊社からの事前の許可を得ること無く複製することを禁じます。この検査報告書を無断で複製、偽造、改ざんすることは違法であり、違反者に対しては法的手段を講ずることとなります。

SGS Japan Inc. | YBP East Tower 12F, 134 Godo-cho Hodogaya-ku Yokohama 240-0005, Japan  
t +81(0) 45 330 1100 f +81(0) 45 330 1108 URL: [www.jp.sgs.com](http://www.jp.sgs.com)

Member of the SGS Group (Société Générale de Surveillance)



**TEST REPORT**

REPORT NO. JP/2018/111201

DATE: January 11, 2019

PAGE: 2 OF 4

KYOCERA CORPORATION

1810 TAKI-CHO SATSUMASENDAI-SHI KAGOSHIMA JAPAN

**TEST RESULT(S)**

ITEM(S)	UNIT	RESULT	METHOD	INST./PLACE	MDL
CADMIUM(Cd)	mg/kg	N.D.	IEC62321-5: 2013	ICP-OES	2
LEAD(Pb)	mg/kg	N.D.	IEC62321-5: 2013	ICP-OES	2
MERCURY(Hg)	mg/kg	N.D.	IEC62321-4: 2013	ICP-OES	2
CHROMIUM VI(Cr(VI))	mg/kg	N.D.	IEC62321-7-1: 2015	UV/VIS	2

NOTES: mg/kg = ppm, N.D. = Not Detected, INST. = INSTRUMENT, MDL = Method Detection Limit

REMARK: Test process and/or expression of test result have been specified by client.

The content of Cr(VI) has been calculated with regard to the sample weight as specified by client.

This Test Report is issued by the Company under its General Conditions of Service printed overleaf or available on request and accessible at <http://www.sgs.com>. Attention is drawn to the limitation of liability, indemnification and jurisdiction issues defined therein. Unless otherwise stated the results shown in this Test Report refer only to the sample(s) tested. This Test Report cannot be reproduced except, in full, without prior approval of the Company. Any unauthorized alteration, forgery or falsification of the content or appearance of this report is unlawful and offenders may be prosecuted to the fullest extent of the law.

JP

この検査報告書は裏面に記載された、もしくは<http://www.sgs.com>で入手が可能なサービスに関する一般的条件に則して発行されます。さらには明記されている弊社の負うべき義務・補償の範囲及び司法管轄の項目をご注意ください。特に明記のない限り、この検査報告書に記載された結果は、検査した試料のみに属します。この書面全体の複製以外には、弊社からの事前の許可を得ること無く複製することを禁じます。この検査報告書を無断で複製、偽造、改ざんすることは違法であり、適法者に対しては法的手段を講ずることとなります。

SGS Japan Inc. | YBP East Tower 12F, 134 Godo-cho Hodogaya-ku Yokohama 240-0005, Japan  
 t +81(0) 45 330 1100 f +81(0) 45 330 1108 URL: [www.jp.sgs.com](http://www.jp.sgs.com)

Member of the SGS Group (Société Générale de Surveillance)



TEST REPORT

REPORT NO. JP/2018/111201

DATE: January 11, 2019

PAGE: 3 OF 4

KYOCERA CORPORATION

1810 TAKI-CHO SATSUMASENDAI-SHI KAGOSHIMA JAPAN

分析フローチャート MEASUREMENT FLOW CHART

1)酸分解前処理において試料を完全分解しています。

The sample was dissolved/ decomposed totally by acid pre-conditioning method according to below flow chart.

2)Cd, Pb, Hg, Cr, Cr(VI), PBB/PBDE

分析担当者 Name of the person in charge of measurement: 及川 聡子 Satoko Oikawa

3)分析責任者 Name of the person responsible for measurement: 大谷 真由美 Mayumi Otani

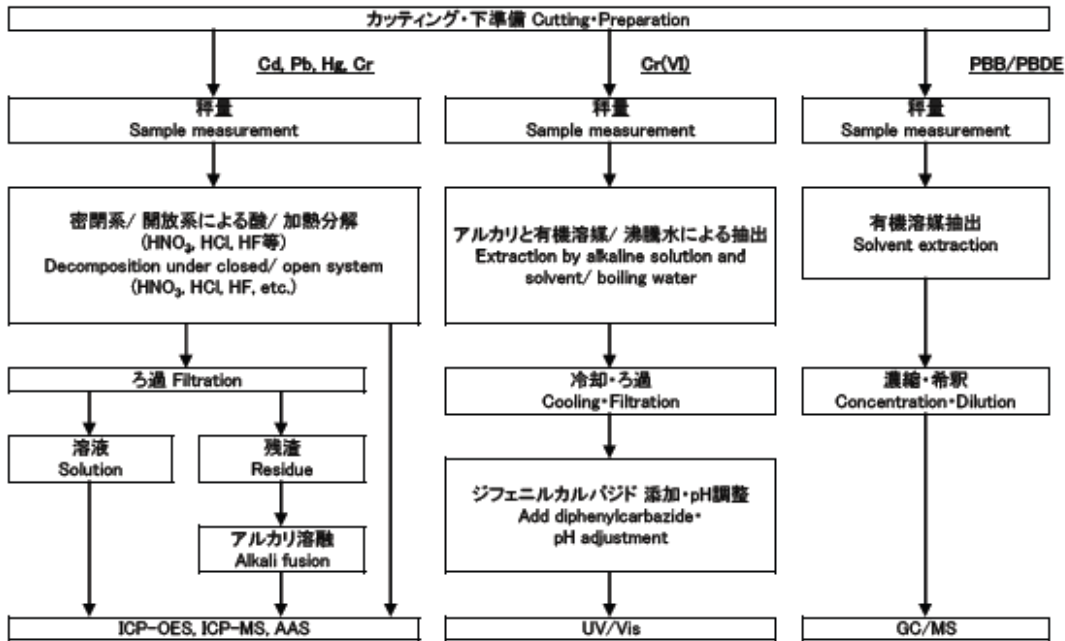

This Test Report is issued by the Company under its General Conditions of Service printed overleaf or available on request and accessible at <http://www.sgs.com>. Attention is drawn to the limitation of liability, indemnification and jurisdiction issues defined therein. Unless otherwise stated the results shown in this Test Report refer only to the sample(s) tested. This Test Report cannot be reproduced except, in full, without prior approval of the Company. Any unauthorized alteration, forgery or falsification of the content or appearance of this test report is unlawful and offenders may be prosecuted to the fullest extent of the law. JP  
 この検査報告書は表面に記載された、もしくは<http://www.sgs.com>で入手可能なサービスに関する一般的条件に明して発行されます。それらに明記されている弊社の自らの責任・補償の範囲及び司法管轄の項目をご確認ください。特に弊に明記のない限り、この検査報告書に記載された結果は、検査した試料のみに属します。この書面全体の複製以外には、弊社からの事前の許可を得ること無く複製することを禁じます。この検査報告書を無断で変更、偽造、改ざんすることは違法であり、違反者に対しては法的手段を講ずることとなります。



TEST REPORT

REPORT NO. JP/2018/111201

DATE: January 11, 2019

PAGE: 4 OF 4

KYOCERA CORPORATION

1810 TAKI-CHO SATSUMASENDAI-SHI KAGOSHIMA JAPAN

SAMPLE IMAGE



<END>

This Test Report is issued by the Company under its General Conditions of Service printed (overleaf or available on request and accessible at <http://www.sgs.com>). Attention is drawn to the limitation of liability, indemnification and jurisdiction issues defined therein. Unless otherwise stated the results shown in this Test Report refer only to the sample(s) tested. This Test Report cannot be reproduced except, in full, without prior approval of the Company. Any unauthorized alteration, forgery or falsification of the content or appearance of this test report is unlawful and offenders may be prosecuted to the fullest extent of the law. JP

この検査報告書は測面に記載された、もしくは<http://www.sgs.com>で入手が可能なサービスに関する一般的な条件に準じて発行されます。さらには明記されている弊社の言うべき世界・補償の範囲及び当該等類の項目を二重取りと見なされ、特に場に対応可能な限り、この検査報告書に記載された結果は、検査した試料のみに基づきます。この書面全体の複製及び改変には、弊社からの事前の許可を得ること無く複製することを禁じます。この検査報告書を無断で複製、偽造、改ざんすることは違法であり、違反者に対しては法的手段を講ずることとなります。

SGS Japan Inc. | YBP East Tower 12F, 134 Godo-cho Hodogaya-ku Yokohama 240-0005, Japan  
 t +81(0) 45 330 1100 f +81(0) 45 330 1108 | URL: [www.jp.sgs.com](http://www.jp.sgs.com)

Member of the SGS Group (Société Générale de Surveillance)



13-3. RAW MATERIAL(LN WAFER)



유효한지 알 수 없음  
 For Question Please  
 Contact with SGS  
 www.sgs.com.tw

**Test Report**

No. : CE/2018/B0606

Date : 2018/11/12

Page : 1 of 9

Shin-Etsu Chemical Co., Ltd.  
 13-1, Isobe 2-chome, Annaka-Shi, Gunma, Japan



The following samples was/were submitted and identified by/on behalf of the applicant as :

Sample Submitted By : Shin-Etsu Chemical Co., Ltd.  
 Sample Description : BLN  
 Lot No. : CJ314S  
 Composition : Lithium Niobate  
 Sample Receiving Date : 2018/11/06  
 Testing Period : 2018/11/06 TO 2018/11/12

**Test Requested :**

- (1) As specified by client, with reference to RoHS 2011/65/EU Annex II and amending Directive (EU) 2015/863 to determine Cadmium, Lead, Mercury, Cr(VI), PBBs, PBDEs, DBP, BBP, DEHP, DIBP contents in the submitted sample(s).
- (2) Please refer to next pages for the other item(s).

**Test Result(s) :** Please refer to following pages.

**Conclusion :** (1) Based on the performed tests on submitted sample(s), the test results of Cadmium, Lead, Mercury, Cr(VI), PBBs, PBDEs, DBP, BBP, DEHP, DIBP comply with the limits as set by RoHS Directive (EU) 2015/863 amending Annex II to Directive 2011/65/EU.

  
 Troy Chang, Manager - Tech  
 Signed for and on behalf of  
 SGS TAIWAN LTD.  
 Chemical Laboratory - Taipei



This document is issued by the Company subject to its General Conditions of Service printed overleaf, available on request or accessible at <http://www.sgs.com/en/Terms-and-Conditions.aspx> and, for electronic formal documents, subject to Terms and Conditions for Electronic Documents at [http://www.sgs.com/en/Terms-and-Conditions/sgs\\_electronic\\_documents.aspx](http://www.sgs.com/en/Terms-and-Conditions/sgs_electronic_documents.aspx). Attention is drawn to the limitation of liability, indemnification and jurisdiction issues defined therein. Any holder of this document is advised that information contained hereon reflects the Company's findings at the time of its intervention only and within the limits of client's instruction, if any. The Company's sole responsibility is to its Client and this document does not exonerate parties to a transaction from exercising all their rights and obligations under the transaction documents. This document cannot be reproduced, stored in full, without prior written approval of the Company. Any unauthorized alteration, forgery or falsification of the content or appearance of this document is unlawful and offenders may be prosecuted to the fullest extent of the law. Unless otherwise stated the results shown in this test report refer only to the sample(s) tested.



## Test Report

No. : CE/2018/B0606

Date : 2018/11/12

Page : 2 of 9

Shin-Etsu Chemical Co., Ltd.  
 13-1, Isobe 2-chome, Annaka-Shi, Gunma, Japan



### Test Result(s)

PART NAME No.1 : WAFER

Test Item(s)	Unit	Method	MDL	Result	Limit
				No.1	
Cadmium (Cd)	mg/kg	With reference to IEC 62321-5 (2013) and performed by ICP-AES.	2	n.d.	100
Lead (Pb)	mg/kg	With reference to IEC 62321-5 (2013) and performed by ICP-AES.	2	n.d.	1000
Mercury (Hg)	mg/kg	With reference to IEC 62321-4 (2013) and performed by ICP-AES.	2	n.d.	1000
Hexavalent Chromium Cr(VI)	mg/kg	With reference to IEC 62321-7-2 (2017) and performed by UV-VIS.	8	n.d.	1000
Sum of PBBs	mg/kg	With reference to IEC 62321-6 (2015) and performed by GC/MS.	-	n.d.	1000
Monobromobiphenyl	mg/kg		5	n.d.	-
Dibromobiphenyl	mg/kg		5	n.d.	-
Tribromobiphenyl	mg/kg		5	n.d.	-
Tetrabromobiphenyl	mg/kg		5	n.d.	-
Pentabromobiphenyl	mg/kg		5	n.d.	-
Hexabromobiphenyl	mg/kg		5	n.d.	-
Heptabromobiphenyl	mg/kg		5	n.d.	-
Octabromobiphenyl	mg/kg		5	n.d.	-
Nonabromobiphenyl	mg/kg		5	n.d.	-
Decabromobiphenyl	mg/kg		5	n.d.	-
Sum of PBDEs	mg/kg		-	n.d.	1000
Monobromodiphenyl ether	mg/kg		5	n.d.	-
Dibromodiphenyl ether	mg/kg		5	n.d.	-
Tribromodiphenyl ether	mg/kg		5	n.d.	-
Tetrabromodiphenyl ether	mg/kg		5	n.d.	-
Pentabromodiphenyl ether	mg/kg		5	n.d.	-
Hexabromodiphenyl ether	mg/kg		5	n.d.	-
Heptabromodiphenyl ether	mg/kg		5	n.d.	-
Octabromodiphenyl ether	mg/kg		5	n.d.	-
Nonabromodiphenyl ether	mg/kg	5	n.d.	-	
Decabromodiphenyl ether	mg/kg	5	n.d.	-	

This document is issued by the Company subject to its General Conditions of Service printed overleaf, available on request or accessible at <http://www.sgs.com.tw/Terms-and-Conditions.aspx> and, for electronic format documents, subject to Terms and Conditions for Electronic Documents at <http://www.sgs.com.tw/Terms-and-Conditions/Electronic-Documents.aspx>. Attention is drawn to the limitation of liability, indemnification and jurisdiction issues defined therein. Any holder of this document is advised that information contained hereon reflects the Company's findings at the time of its intervention only and within the limits of client's instruction, if any. The Company's sole responsibility is to its Client and this document does not exonerate parties to a transaction from exercising all their rights and obligations under the transaction documents. This document cannot be reproduced, except in full, without prior written approval of the Company. Any unauthorized alteration, forgery or falsification of the content or appearance of this document is unlawful and offenders may be prosecuted to the fullest extent of the law. Unless otherwise stated the results shown in this test report refer only to the sample(s) tested.

SGS Taiwan Ltd. 台灣檢驗科技股份有限公司 | 25, Wu Chuan 7th Road, New Taipei Industrial Park, Wu Ku District, New Taipei City, Taiwan / 新北市五股區新北產業園區成泰街25號  
 T+886 0292299 3939 F+886 0292299 3237 www.sgs.tw

Member of the SGS Group



**Test Report**

No. : CE/2018/B0606

Date : 2018/11/12

Page : 3 of 9

Shin-Etsu Chemical Co., Ltd.  
 13-1, Isobe 2-chome, Annaka-Shi, Gunma, Japan



Test Item(s)	Unit	Method	MDL	Result	Limit
				No.1	
DEHP (Di- (2-ethylhexyl) phthalate) (CAS No.: 117-81-7)	mg/kg	With reference to IEC 62321-8 (2017). Analysis was performed by GC/MS.	50	n.d.	1000
BBP (Butyl Benzyl phthalate) (CAS No.: 85-68-7)	mg/kg		50	n.d.	1000
DBP (Dibutyl phthalate) (CAS No.: 84-74-2)	mg/kg		50	n.d.	1000
DIBP (Di-isobutyl phthalate) (CAS No.: 84-69-5)	mg/kg		50	n.d.	1000
Halogen-Chlorine (Cl) (CAS No.: 22537-15-1)	mg/kg	With reference to BS EN 14582 (2016). Analysis was performed by IC.	50	n.d.	-
Halogen-Bromine (Br) (CAS No.: 10097-32-2)	mg/kg		50	n.d.	-
Antimony (Sb)	mg/kg	With reference to US EPA 3050B (1996). Analysis was performed by ICP-AES.	2	n.d.	-
Beryllium (Be)	mg/kg	With reference to US EPA 3050B (1996). Analysis was performed by ICP-AES.	2	n.d.	-

**Note :**

1. mg/kg = ppm ; 0.1wt% = 1000ppm
2. MDL = Method Detection Limit
3. n.d. = Not Detected = less than MDL
4. " - " = Not Regulated

This document is issued by the Company subject to its General Conditions of Service printed overleaf, available on request or accessible at <http://www.sgs.com/tn/forms-and-conditions.aspx> and, for electronic formal documents, subject to Terms and Conditions for Electronic Documents at <http://www.sgs.com/tn/forms-and-conditions.aspx#document.aspx>. Attention is drawn to the limitation of liability, indemnification and jurisdiction issues defined therein. Any holder of this document is advised that information contained herein reflects the Company's findings at the time of its intervention only and within the limits of client's instruction, if any. The Company's sole responsibility is to its Client and this document does not exonerate parties to a transaction from exercising all their rights and obligations under the transaction documents. This document cannot be reproduced, except in full, without prior written approval of the Company. Any unauthorized alteration, forgery or falsification of the content or appearance of this document is unlawful and offenders may be prosecuted to the fullest extent of the law. Unless otherwise stated the results shown in this test report refer only to the sample(s) tested.

SGS Taiwan Ltd. 台灣檢驗科技股份有限公司 | 25, Wu Chuan 7th Road, New Taipei Industrial Park, Wu Ku District, New Taipei City, Taiwan / 新北市五股區新北產業園區五權七路25號 | +886 (02) 2299 9939 | +886 (02) 2299 3237 | www.sgs.tw

Member of the SGS Group



# Test Report

No. : CE/2018/B0606

Date : 2018/11/12

Page : 4 of 9

Shin-Etsu Chemical Co., Ltd.  
13-1, Isobe 2-chome, Annaka-Shi, Gunma, Japan



### Analytical flow chart of Heavy Metal

These samples were dissolved totally by pre-conditioning method according to below flow chart. (Cr<sup>6+</sup> test method excluded)

- Technician : Rita Chen
- Supervisor: Troy Chang

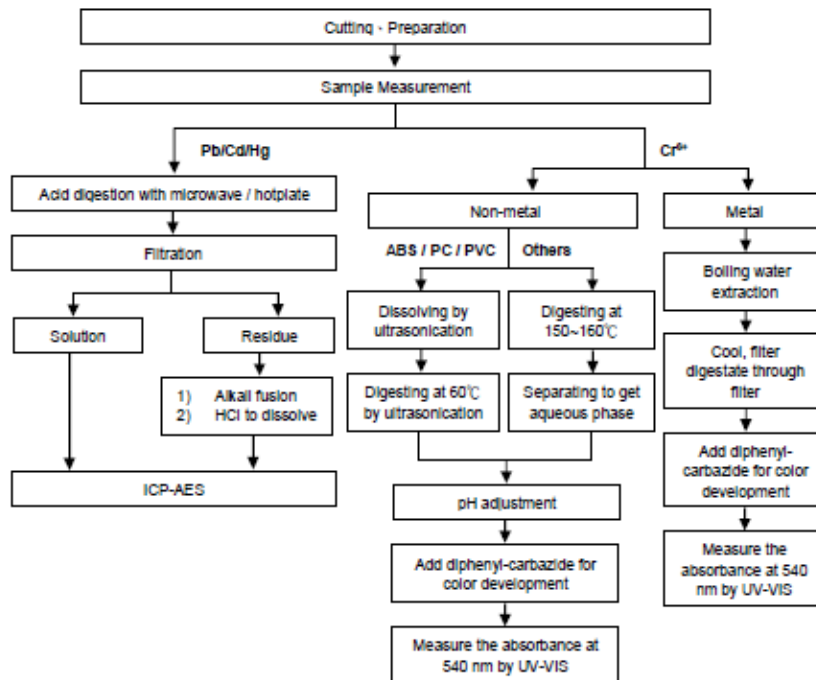

This document is issued by the Company subject to its General Conditions of Service printed overleaf, available on request or accessible at <http://www.sgs.com/en/Terms-and-Conditions.aspx> and, for electronic formal documents, subject to Terms and Conditions for Electronic Documents at <http://www.sgs.com/en/Terms-and-Conditions/epmpe/Document1.aspx>. Attention is drawn to the limitation of liability, indemnification and jurisdiction issues defined therein. Any holder of this document is advised that information contained herein reflects the Company's findings at the time of its intervention only and within the limits of client's instruction, if any. The Company's sole responsibility is to its Client and this document does not exonerate parties to a transaction from exercising all their rights and obligations under the transaction documents. This document cannot be reproduced, except in full, without prior written approval of the Company. Any unauthorized alteration, forgery or falsification of the content or appearance of this document is unlawful and offenders may be prosecuted to the fullest extent of the law. Unless otherwise stated the results shown in this test report refer only to the samples tested.

SGS Taiwan Ltd. 台灣檢驗科技股份有限公司 | 25, Wu Chyuan 7th Road, New Taipei Industrial Park, Wu Ku District, New Taipei City, Taiwan/新北市民權路七段25號  
T+886 (02)2299 3939 T+886 (02)2299 3237 www.sgs.tw

Member of the SGS Group



# Test Report

No. : CE/2018/B0606

Date : 2018/11/12

Page : 5 of 9

Shin-Etsu Chemical Co., Ltd.

13-1, Isobe 2-chome, Annaka-Shi, Gunma, Japan



### Analytical flow chart – PBB / PBDE

- Technician : Yaling Tu
- Supervisor: Troy Chang

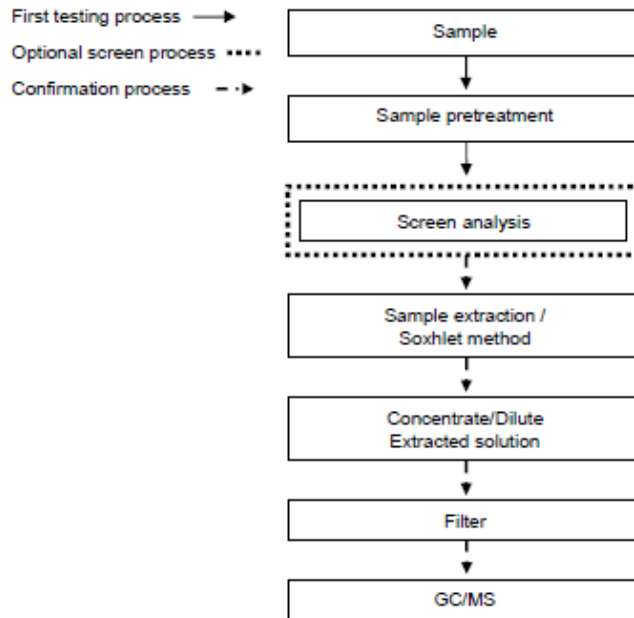

This document is issued by the Company subject to its General Conditions of Service printed overleaf, available on request or accessible at <http://www.sgs.com/en/Terms-and-Conditions.aspx> and, for electronic format documents, subject to Terms and Conditions for Electronic Documents at <http://www.sgs.com/en/Terms-and-Conditions/Electronic-Documents.aspx>. Attention is drawn to the limitation of liability, indemnification and jurisdiction issues defined therein. Any holder of this document is advised that information contained herein reflects the Company's findings at the time of its intervention only and within the limits of client's instruction, if any. The Company's sole responsibility is to its Client and this document does not exonerate parties to a transaction from exercising all their rights and obligations under the transaction documents. This document cannot be reproduced, except in full, without prior written approval of the Company. Any unauthorized alteration, forgery or falsification of the content or appearance of this document is unlawful and offenders may be prosecuted to the fullest extent of the law. Unless otherwise stated the results shown in this test report refer only to the sample(s) tested.

SGS Taiwan Ltd. 台灣檢驗科技股份有限公司 | 25, Wu Chuan 7th Road, New Taipei Industrial Park, Wu Ku District, New Taipei City, Taiwan / 新北市五股區新北產業園區五權七路25號  
 14886 0222209 3939 14888 0222209 3237 www.sgs.tw

Member of the SGS Group



**Test Report**

No. : CE/2018/B0606

Date : 2018/11/12

Page : 6 of 9

Shin-Etsu Chemical Co., Ltd.  
 13-1, Isobe 2-chome, Annaka-Shi, Gunma, Japan



**Analytical flow chart - Phthalate**

- Technician: Yaling Tu
- Supervisor: Troy Chang

**【Test method: IEC 62321-8】**

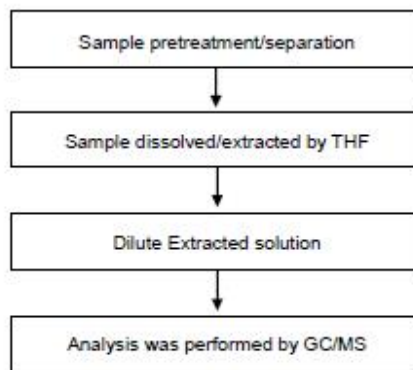

This document is issued by the Company subject to its General Conditions of Service printed overleaf, available on request or accessible at <http://www.sgs.com/en/terms-and-conditions.aspx> and, for electronic format documents, subject to Terms and Conditions for Electronic Documents at <http://www.sgs.com/en/terms-and-conditions.aspx/Document.aspx>. Attention is drawn to the limitation of liability, indemnification and jurisdiction issues defined therein. Any holder of this document is advised that information contained hereon reflects the Company's findings at the time of its intervention only and within the limits of client's instruction, if any. The Company's sole responsibility is to its Client and this document does not exonerate parties to a transaction from exercising all their rights and obligations under the transaction documents. This document cannot be reproduced, except in full, without prior written approval of the Company. Any unauthorized alteration, forgery or falsification of the content or appearance of this document is unlawful and offenders may be prosecuted to the fullest extent of the law. Unless otherwise stated the results shown in this test report refer only to the sample(s) tested.

SGS Taiwan Ltd. 台灣檢驗科技股份有限公司 | 25, Wu Chuan 7th Road, New Taipei Industrial Park, Wu Ku District, New Taipei City, Taiwan / 新北市新莊區吳庫路七號25號  
 t+886 0222299 3939 f+886 0222299 3237 www.sgs.tw

Member of the SGS Group



**Test Report**

No. : CE/2018/B0606

Date : 2018/11/12

Page : 7 of 9

Shin-Etsu Chemical Co., Ltd.  
13-1, Isobe 2-chome, Annaka-Shi, Gunma, Japan



Analytical flow chart - Halogen

- Technician: Rita Chen
- Supervisor: Troy Chang

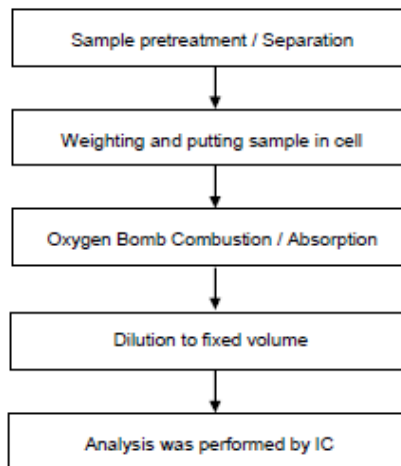

This document is issued by the Company subject to its General Conditions of Service printed overleaf, available on request or accessible at <http://www.sgs.com/en/forms-and-conditions.aspx> and, for electronic format documents, subject to Terms and Conditions for Electronic Documents at <http://www.sgs.com/en/forms-and-conditions.aspx#document.aspx>. Attention is drawn to the limitation of liability, indemnification and jurisdiction issues defined therein. Any holder of this document is advised that information contained hereon reflects the Company's findings at the time of its intervention only and within the limits of client's instruction, if any. The Company's sole responsibility is to its Client and this document does not exonerate parties to a transaction from exercising all their rights and obligations under the transaction documents. This document cannot be reproduced, except in full, without prior written approval of the Company. Any unauthorized alteration, forgery or falsification of the content or appearance of this document is unlawful and offenders may be prosecuted to the fullest extent of the law. Unless otherwise stated the results shown in this test report refer only to the sample(s) tested.

SGS Taiwan Ltd. 台灣檢驗科技股份有限公司 | 25, Wu Chuan 7th Road, New Taipei Industrial Park, Wu Ku District, New Taipei City, Taiwan / 新北市五股區新北大業路七號25號  
+886 (0)22299 3939 +886 (0)2299 3237 | www.sgs.tw

Member of the SGS Group



# Test Report

No. : CE/2018/B0606

Date : 2018/11/12

Page : 8 of 9

Shin-Etsu Chemical Co., Ltd.  
13-1, Isobe 2-chome, Annaka-Shi, Gunma, Japan



These samples were dissolved totally by pre-conditioning method according to below flow chart.

- Technician: Rita Chen
- Supervisor: Troy Chang

### Flow Chart of digestion for the elements analysis performed by ICP-AES

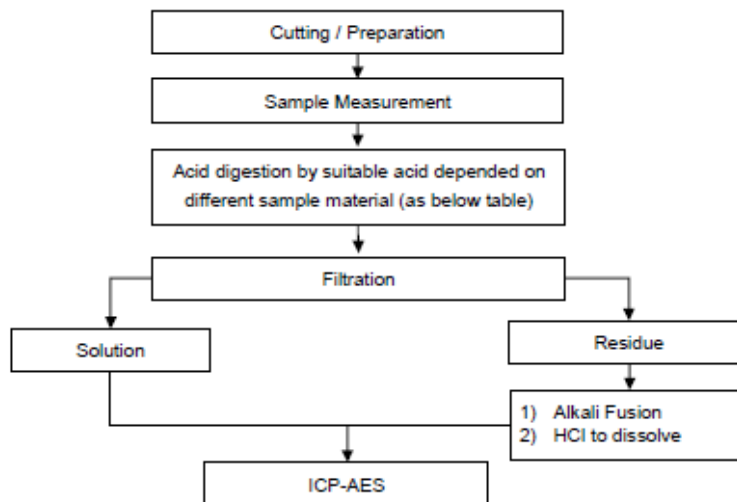

Steel, copper, aluminum, solder	Aqua regia, HNO <sub>3</sub> , HCl, HF, H <sub>2</sub> O <sub>2</sub>
Glass	HNO <sub>3</sub> /HF
Gold, platinum, palladium, ceramic	Aqua regia
Silver	HNO <sub>3</sub>
Plastic	H <sub>2</sub> SO <sub>4</sub> , H <sub>2</sub> O <sub>2</sub> , HNO <sub>3</sub> , HCl
Others	Added appropriate reagent to total digestion

This document is issued by the Company subject to its General Conditions of Service printed overleaf, available on request or accessible at <http://www.sgs.com/en/Terms-and-Conditions.aspx> and, for electronic formal documents, subject to Terms and Conditions for Electronic Documents at <http://www.sgs.com/en/Terms-and-Conditions/ReleaseDocument.aspx>. Attention is drawn to the limitation of liability, indemnification and jurisdiction issues defined therein. Any holder of this document is advised that information contained hereon reflects the Company's findings at the time of its intervention only and within the limits of client's instruction, if any. The Company's sole responsibility is to its Client and this document does not exonerate parties to a transaction from exercising all their rights and obligations under the transaction documents. This document cannot be reproduced, except in full, without prior written approval of the Company. Any unauthorized affixation, forgery or falsification of the content or appearance of this document is unlawful and offenders may be prosecuted to the fullest extent of the law. Unless otherwise stated the results shown in this test report refer only to the sample(s) tested.

SGS Taiwan Ltd. 台灣檢驗科技股份有限公司

25, Wu Chuan 7th Road, New Taipei Industrial Park, Wu Ku District, New Taipei City, Taiwan / 新北市五股區新北產業園區成吉里7號  
t+886 022229 3939 f+886 022229 3237 www.sgs.tw

Member of the SGS Group





Test Report

No. : CE/2018/B0606

Date : 2018/11/12

Page : 9 of 9

Shin-Etsu Chemical Co., Ltd.  
 13-1, Isobe 2-chome, Annaka-Shi, Gunma, Japan



\* The tested sample / part is marked by an arrow if it's shown on the photo. \*

CE/2018/B0606

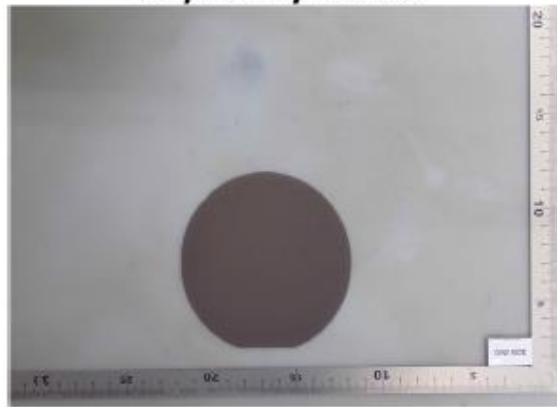

CE/2018/B0606

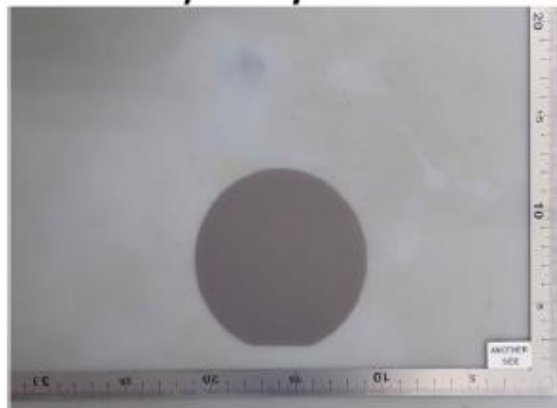

\*\* End of Report \*\*

This document is issued by the Company subject to its General Conditions of Service printed overleaf, available on request or accessible at <http://www.sgs.com.tw/7/terms-and-conditions.aspx> and, for electronic format documents, subject to Terms and Conditions for Electronic Documents at <http://www.sgs.com.tw/7/terms-and-conditions.aspx>. Attention is drawn to the limitation of liability, indemnification and jurisdiction issues defined therein. Any holder of this document is advised that information contained herein reflects the Company's findings at the time of its intervention only and within the limits of client's instruction, if any. The Company's sole responsibility is to its Client and this document does not exonerate parties to a transaction from exercising all their rights and obligations under the transaction documents. This document cannot be reproduced, except in full, without prior written approval of the Company. Any unauthorized alteration, forgery or falsification of the content or appearance of this document is unlawful and offenders may be prosecuted to the fullest extent of the law. Unless otherwise stated the results shown in this test report refer only to the sample(s) tested.

SGS Taiwan Ltd. 台灣檢驗科技股份有限公司 | 25, Wu Chyuan 7th Road, New Taipei Industrial Park, Wu Ku District, New Taipei City, Taiwan / 新北市五股區新北產業園區 第七段 75號  
 T+886 (0)272299 3239 T+886 (0)27209 3237 www.sgs.tw

Member of the SGS Group

13-4. RAW MATERIAL(GOLD WIRE)



Test Report

No. SHAEC1818655211

Date: 24 Aug 2018

Page 1 of 23

TANAKA ELECTRONICS (HANGZHOU) CO.,LTD.

F1 AREA, WEST NO.19 STREET, NORTH NO.10 STREET, HANGZHOU ECONOMIC&TECHNOLOGICAL DEVELOPMENT ZONE,HANGZHOU

The following sample(s) was/were submitted and identified on behalf of the clients as : Au Bonding Wire

SGS Job No. : SP18-028471 - SH  
 Date of Sample Received : 17 Aug 2018  
 Testing Period : 17 Aug 2018 - 23 Aug 2018  
 Test Requested : Selected test(s) as requested by client.  
 Test Method : Please refer to next page(s).  
 Test Results : Please refer to next page(s).  
 Conclusion : Based on the performed tests on submitted sample(s), the results of Cadmium, Lead, Mercury, Hexavalent chromium, Polybrominated biphenyls (PBBs), Polybrominated diphenyl ethers (PBDEs) and Phthalates such as Bis(2-ethylhexyl) phthalate (DEHP), Butyl benzyl phthalate (BBP), Dibutyl phthalate (DBP) and Diisobutyl phthalate (DIBP) comply with the limits as set by RoHS Directive (EU) 2015/863 amending Annex II to Directive 2011/65/EU.  
 When tested as specified, Dimethyl fumarate(DMF) content of the submitted sample comply with Commission Regulation (EU) No 412/2012 and Entry 61 of Annex XVII of REACH Regulation (EC) No 1907/2006

Signed for and on behalf of  
 SGS-CSTC Standards Technical Services (Shanghai) Co., Ltd.

*Jenny Yao*

Jenny Yao  
 Approved Signatory



Unless otherwise agreed in writing, this document is issued by the Company subject to its General Conditions of Service printed overleaf, available on request or accessible at <http://www.sgs.com/en/terms-and-conditions.aspx> and, for electronic format documents, subject to Terms and Conditions for Electronic Documents at <http://www.sgs.com/en/terms-and-conditions/terms-e-document.aspx>. Attention is drawn to the limitation of liability, indemnification and jurisdiction issues defined therein. Any holder of this document is advised that information contained hereon reflects the Company's findings at the time of its intervention only and within the limits of Client's instructions, if any. The Company's sole responsibility is to its Client and this document does not exonerate parties to a transaction from exercising all their rights and obligations under the transaction documents. This document cannot be reproduced except in full, without prior written approval of the Company. Any unauthorized alteration, forgery or falsification of the content or appearance of this document is unlawful and offenders may be prosecuted to the fullest extent of the law. Unless otherwise stated the results shown in this test report refer only to the sample(s) tested.  
 Attention: To check the authenticity of testing inspection report & certificate, please contact us at telephone: (86-755) 8307 9443, [www.cn.china@sgs.com](mailto:www.cn.china@sgs.com)  
 3<sup>rd</sup> Building No.888 Yishan Road Xuhai District, Shanghai China 200233 TEL (86-21) 61402593 FAX (86-21) 64953679 [www.sgs.com.cn](http://www.sgs.com.cn)  
 中国·上海·徐汇区宜山路888号3号楼 邮编: 200233 TEL (86-21) 61402594 FAX (86-21) 61150899 e [sgs.china@sgs.com](mailto:sgs.china@sgs.com)

Member of the SGS Group (SGS SA)



**Test Report**

No. SHAEC1818655211

Date: 24 Aug 2018

Page 2 of 23

Test Results :

Test Part Description :

Specimen No.	SGS Sample ID	Description
SN1	SHA18-186552.005	Golden metal wire

Remarks :

- (1) 1 mg/kg = 1 ppm = 0.0001%
- (2) MDL = Method Detection Limit
- (3) ND = Not Detected ( < MDL )
- (4) "-" = Not Regulated

RoHS Directive (EU) 2015/863 amending Annex II to Directive 2011/65/EU

Test Method : With reference to IEC 62321-4:2013+AMD1:2017, IEC62321-5:2013, IEC62321-7-1:2015, IEC 62321-6:2015 and IEC62321-8:2017, analyzed by ICP-OES, UV-Vis and GC-MS.

Test Item(s)	Limit	Unit	MDL	005
Cadmium (Cd)	100	mg/kg	2	ND
Lead (Pb)	1000	mg/kg	2	ND
Mercury (Hg)	1000	mg/kg	2	ND
Hexavalent Chromium (Cr(VI))*	-	µg/cm <sup>2</sup>	0.10	ND
Sum of PBBs	1000	mg/kg	-	ND
Monobromobiphenyl	-	mg/kg	5	ND
Dibromobiphenyl	-	mg/kg	5	ND
Tribromobiphenyl	-	mg/kg	5	ND
Tetrabromobiphenyl	-	mg/kg	5	ND
Pentabromobiphenyl	-	mg/kg	5	ND
Hexabromobiphenyl	-	mg/kg	5	ND
Heptabromobiphenyl	-	mg/kg	5	ND
Octabromobiphenyl	-	mg/kg	5	ND
Nonabromobiphenyl	-	mg/kg	5	ND
Decabromobiphenyl	-	mg/kg	5	ND
Sum of PBDEs	1000	mg/kg	-	ND
Monobromodiphenyl ether	-	mg/kg	5	ND
Dibromodiphenyl ether	-	mg/kg	5	ND
Tribromodiphenyl ether	-	mg/kg	5	ND
Tetrabromodiphenyl ether	-	mg/kg	5	ND



Unless otherwise agreed in writing, this document is issued by the Company subject to its General Conditions of Service printed overleaf, available on request or accessible at <http://www.sgs.com/en/Terms-and-Conditions.aspx> and, for electronic formal documents, subject to Terms and Conditions for Electronic Documents at <http://www.sgs.com/en/Terms-and-Conditions/Terms-e-Documents.aspx>. Attention is drawn to the limitation of liability, indemnification and jurisdiction issues defined therein. Any holder of this document is advised that information contained hereon reflects the Company's findings at the time of its intervention only and within the limits of Client's instructions, if any. The Company's sole responsibility is to its Client and this document does not exonerate parties to a transaction from exercising all their rights and obligations under the transaction documents. This document cannot be reproduced except in full, without prior written approval of the Company. Any unauthorized alteration, forgery or falsification of the content or appearance of this document is unlawful and offenders may be prosecuted to the fullest extent of the law. Unless otherwise stated the results shown in this test report refer only to the sample(s) tested.

Attention: To check the authenticity of testing inspection report & certificate, please contact us at telephone: (86-755) 8107 8443, or email: CR\_Dispatch@sgs.com

SGS-CTC (Shanghai) Inspection & Testing Service Co., Ltd. 3<sup>rd</sup> Building/No.889 Yishan Road Xuhui District, Shanghai China 200233 TEL: (86-21) 61402593 FAX: (86-21) 64953679 www.sgs.com.cn  
 中国·上海·徐汇区宜山路889号3号楼 邮编: 200233 1HL (86-21) 61402594 1HL (86-21) 61156899 e.sgs.china@sgs.com

Member of the SGS Group (SGS SA)



**Test Report**

No. SHAEC1818655211

Date: 24 Aug 2018

Page 3 of 23

Test Item(s)	Limit	Unit	MDL	005
Pentabromodiphenyl ether	-	mg/kg	5	ND
Hexabromodiphenyl ether	-	mg/kg	5	ND
Heptabromodiphenyl ether	-	mg/kg	5	ND
Octabromodiphenyl ether	-	mg/kg	5	ND
Nonabromodiphenyl ether	-	mg/kg	5	ND
Decabromodiphenyl ether	-	mg/kg	5	ND
Di-butyl Phthalate (DBP)	1000	mg/kg	50	ND
Benzyl Butyl Phthalate (BBP)	1000	mg/kg	50	ND
Di-2-Ethyl Hexyl Phthalate (DEHP)	1000	mg/kg	50	ND
Diisobutyl Phthalates (DIBP)	1000	mg/kg	50	ND

**Notes :**

- (1) The maximum permissible limit is quoted from RoHS Directive (EU) 2015/863. IEC 62321 series is equivalent to EN 62321 series  
[http://www.cenelec.eu/dyn/www/f?p=104:30:1742232870351101:::FSP\\_ORG\\_ID,FSP\\_LANG\\_ID:1258637,25](http://www.cenelec.eu/dyn/www/f?p=104:30:1742232870351101:::FSP_ORG_ID,FSP_LANG_ID:1258637,25)
- (2) ▽ = a. The sample is positive for CrVI if the CrVI concentration is greater than 0.13 µg/cm<sup>2</sup>. The sample coating is considered to contain CrVI  
 b. The sample is negative for CrVI if CrVI is ND (concentration less than 0.10 µg/cm<sup>2</sup>). The coating is considered a non-CrVI based coating  
 c. The result between 0.10 µg/cm<sup>2</sup> and 0.13 µg/cm<sup>2</sup> is considered to be inconclusive - unavoidable coating variations may influence the determination  
 Information on storage conditions and production date of the tested sample is unavailable and thus Cr(VI) results represent status of the sample at the time of testing.

**Element(s)**

Test Method : With reference to US EPA Method 3050B:1996, analysis was performed by ICP-OES.

Test Item(s)	CAS NO.	Unit	MDL	005
Beryllium (Be)		mg/kg	5	ND
Beryllium oxide (BeO) ♦		mg/kg	15	ND
Antimony (Sb)		mg/kg	10	ND
Antimony trioxide (Sb <sub>2</sub> O <sub>3</sub> )♦		mg/kg	12	ND
Arsenic (As)		mg/kg	10	ND
Diarsenic trioxide (As <sub>2</sub> O <sub>3</sub> ) ♦	1327-53-3	mg/kg	10	ND
Diarsenic pentaoxide (As <sub>2</sub> O <sub>5</sub> ) ♦	1303-28-2	mg/kg	10	ND

**Notes :**

- (1) ♦ Calculated concentration of BeO is based on the identified Be



Unless otherwise agreed in writing, this document is issued by the Company subject to its General Conditions of Service printed overleaf, available on request or accessible at <http://www.sgs.com/en/Terms-and-Conditions.aspx> and, for electronic format documents, subject to Terms and Conditions for Electronic Documents at <http://www.sgs.com/en/Terms-and-Conditions/Terms-e-Document.aspx>. Attention is drawn to the limitation of liability, indemnification and jurisdiction clauses defined therein. Any holder of this document is advised that information contained herein reflects the Company's findings at the time of its intervention only and within the limits of Client's instructions, if any. The Company's sole responsibility is to its Client and this document does not exonerate parties to a transaction from exercising all their rights and obligations under the transaction documents. This document cannot be reproduced except in full, without prior written approval of the Company. Any unauthorized alteration, forgery or falsification of the content or appearance of this document is unlawful and offenders may be prosecuted to the fullest extent of the law. Unless otherwise stated the results shown in this test report refer only to the sample(s) tested.  
 Attention: To check the authenticity of testing/inspection report & certificate, please contact us at telephone: (86-755) 8307 1443, or email: [CN.Doccheck@sgs.com](mailto:CN.Doccheck@sgs.com)  
 3<sup>rd</sup> Building, No. 889 Yishan Road, Xuhui District, Shanghai China 200233 1EAE (86-21) 61402553 1EAE (86-21) 64953679 [www.sgs.com](http://www.sgs.com) [www.sgs.com](http://www.sgs.com)  
 中国·上海·徐汇区宜山路889号3号楼 邮编: 200233 1HL (86-21) 61402594 1HL (86-21) 61158899 e [sgs.china@sgs.com](mailto:sgs.china@sgs.com)

Member of the SGS Group (SGS SA)

**Test Report**

No. SHAEC1818655211

Date: 24 Aug 2018

Page 4 of 23

Calculated concentration of Sb<sub>2</sub>O<sub>3</sub> is based on the identified Sb  
 Calculated concentration of diarsenic pentoxide and diarsenic trioxide are based on the identified arsenic and lead

**Halogen**

Test Method : With reference to EN 14582: 2016 , analysis was performed by IC.

Test Item(s)	Unit	MDL	005
Fluorine (F)	mg/kg	50	ND
Chlorine (Cl)	mg/kg	50	ND
Bromine (Br)	mg/kg	50	ND
Iodine (I)	mg/kg	50	ND

**Organic-tin compounds**

Test Method : With reference to ISO 17353: 2004 with carbamate, analysis was performed by GC-MS.

Test Item(s)	Unit	MDL	005
Tributyl tin (TBT)	mg/kg	0.02	ND
Dibutyl tin (DBT)	mg/kg	0.02	ND
Dioctyl tin (DOT)	mg/kg	0.02	ND
Tripropyltin (TPT)	mg/kg	0.02	ND
Bis(tributyltin) oxide (TBTO) *	mg/kg	0.02	ND

**Notes :**

(1) \*Calculated concentration of TBTO is based on the identified TBT.

**Polychlorinated Naphthalenes (PCNs)**

Test Method : With reference to US EPA 8081B: 2007, analysis was performed by GC-MS

Test Item(s)	Unit	MDL	005
2-Chlorinated Naphthalene	mg/kg	5	ND
1,4-Dichlorinated Naphthalene	mg/kg	5	ND
1,5-Dichlorinated Naphthalene	mg/kg	5	ND
1,2-Dichlorinated Naphthalene	mg/kg	5	ND
1,8-Dichlorinated Naphthalene	mg/kg	5	ND
1,2,3-Trichlorinated Naphthalene	mg/kg	5	ND



Unless otherwise agreed in writing, this document is issued by the Company subject to its General Conditions of Service printed overleaf, available on request or accessible at <http://www.sgs.com/en/Terms-and-Conditions.aspx> and, for electronic forest documents, subject to Terms and Conditions for Electronic Documents at <http://www.sgs.com/en/Terms-and-Conditions/Terms-e-Documents.aspx>. Attention is drawn to the limitation of liability, indemnification and jurisdiction issues defined therein. Any holder of this document is advised that information contained hereon reflects the Company's findings at the time of its intervention only and within the limits of Client's instructions, if any. The Company's sole responsibility is to its Client and this document does not exonerate parties to a transaction from exercising all their rights and obligations under the transaction documents. This document cannot be reproduced except in full, without prior written approval of the Company. Any unauthorized alteration, forgery or falsification of the content or appearance of this document is unlawful and offenders may be prosecuted to the fullest extent of the law. Unless otherwise stated the results shown in this test report refer only to the sample(s) tested.  
 Attention: To check the authenticity of testing/inspection report & certificate, please contact us at telephone: (86-755) 8307 1443, or email: [CN.Doccheck@sgs.com](mailto:CN.Doccheck@sgs.com)

 SGS-CSG Technical Services (Shanghai) Co., Ltd.  
 Testing Center of China

 3<sup>rd</sup> Building, No. 889 Yinan Road Xuhui District, Shanghai, China 200233 TEL: (86-21) 61402593 FAX: (86-21) 64953679 www.sgs.com.cn  
 中国·上海·徐汇区宜山路889号3号楼 邮编: 200233 1HL (86-21) 61402594 1HL (86-21) 61158889 e: [sgs.china@sgs.com](mailto:sgs.china@sgs.com)

Member of the SGS Group (SGS SA)

**Test Report**

No. SHAEC1818655211

Date: 24 Aug 2018

Page 5 of 23

<u>Test Item(s)</u>	<u>Unit</u>	<u>MDL</u>	<u>005</u>
1,2,3,4-Tetrachlorinated Naphthalene	mg/kg	5	ND
1,2,3,4,6-Pentachlorinated Naphthalene	mg/kg	5	ND
Octa-chlorinaed Naphthalene	mg/kg	5	ND
1-Chlorinated Naphthalene	mg/kg	5	ND

**Short-chain Chlorinated Paraffin (SCCP) and Medium-chain Chlorinated Paraffin (MCCP)**

Test Method : With reference to US EPA 3550C: 2007, analysis was performed by GC-ECD / GC-NCI-MS

<u>Test Item(s)</u>	<u>Unit</u>	<u>MDL</u>	<u>005</u>
Short-chain Chlorinated Paraffin (SCCP) (C <sub>10</sub> -C <sub>13</sub> )	mg/kg	50	ND
Medium-chain Chlorinated Paraffin (MCCP) (C <sub>14</sub> -C <sub>17</sub> )	mg/kg	50	ND

**Red Phosphorus**

Test Method : SGS in house method(SHTC- CHEM- SOP -342-T), Analysis was performed by ICP-OES and Pyrolysis-GC/MS

<u>Test Item(s)</u>	<u>Unit</u>	<u>MDL</u>	<u>005</u>
Red Phosphorus	mg/kg	500	ND

**Notes :**

For Positive result, the testing result is based on the worst-case scenario, and confirmed by Pyrolysis-GC-MS.

**Tetrabromobisphenol A (TBBP-A)**

Test Method : With reference to US EPA 3540C: 1996, analysis was performed by GC-MS.

<u>Test Item(s)</u>	<u>Unit</u>	<u>MDL</u>	<u>005</u>
Tetrabromobisphenol A (TBBP-A)	mg/kg	10	ND



Unless otherwise agreed in writing, this document is issued by the Company subject to its General Conditions of Service printed overleaf, available on request or accessible at <http://www.sgs.com/en/Terms-and-Conditions.aspx> and, for electronic format documents, subject to Terms and Conditions for Electronic Documents at <http://www.sgs.com/en/Terms-and-Conditions/Terms-e-Documents.aspx>. Attention is drawn to the limitation of liability, indemnification and jurisdiction issues defined therein. Any holder of this document is advised that information contained hereon reflects the Company's findings at the time of its intervention only and within the limits of Client's instructions, if any. The Company's sole responsibility is to its Client and this document does not exonerate parties to a transaction from exercising all their rights and obligations under the transaction documents. This document cannot be reproduced except in full, without prior written approval of the Company. Any unauthorized alteration, forgery or falsification of the content or appearance of this document is unlawful and offenders may be prosecuted to the fullest extent of the law. Unless otherwise stated the results shown in this test report refer only to the sample(s) tested.

Attention: To check the authenticity of testing /inspection report & certificate, please contact us at telephone: (86-755) 8307 9443, or email: [CN.Doccheck@sgs.com](mailto:CN.Doccheck@sgs.com)

 SGS CSTI (Shanghai Technical Services) Co., Ltd.  
 Testing Center One Westway

 3<sup>rd</sup> Building, No. 889 Yixian Road, Xuhui District, Shanghai, China 200233 TEL (86-21) 61402553 FAX (86-21) 64853679 [www.sgs.com.cn](http://www.sgs.com.cn)  
 中国·上海·徐汇区宜山路889号3号楼 邮编: 200233 TEL (86-21) 61402594 FAX (86-21) 61159889 [sgs.china@sgs.com](mailto:sgs.china@sgs.com)

Member of the SGS Group (SGS SA)



Test Report

No. SHAEC1818655211

Date: 24 Aug 2018

Page 6 of 23

PVC (Polyvinyl chloride)

Test Method : In-house method (SHTC-CHEM-SOP-115-T), analysis was performed by FTIR/HATR.

Test Item(s)	CAS NO.	Unit	MDL	005
PVC	9002-86-2	-	-	Negative

Notes :

(1) Negative=Undetectable,Positive=Detectable

Commission Regulation (EU) No 412/2012 and Entry 61 of Annex XVII of REACH Regulation (EC) No 1907/2006 - Dimethyl fumarate(DMF)

Test Method : Solvent extraction, analysis was performed by GC-MS.

Test Item(s)	Limit	Unit	MDL	005
Dimethyl fumarate(DMF)	0.1	mg/kg	0.1	ND

Bisphenol-A

Test Method : With reference to US EPA 3550C: 2007, analysis was performed by HPLC-DAD-MS.

Test Item(s)	Unit	MDL	005
Bisphenol-A	mg/kg	1	ND

Polychlorinated Terphenyls (PCTs)

Test Method : With reference to US EPA 8082A: 2007, analysis was performed by GC-MS

Test Item(s)	Unit	MDL	005
Aroclor 5432	mg/kg	5	ND
Aroclor 5442	mg/kg	5	ND

Hexabromocyclododecane (HBCDD)

Test Method : With reference to IEC 62321:2008, analysis was performed by GC-MS.



Unless otherwise agreed in writing, this document is issued by the Company subject to its General Conditions of Service printed overleaf, available on request or accessible at <http://www.sgs.com/en/Terms-and-Conditions.aspx> and, for electronic format documents, subject to Terms and Conditions for Electronic Documents at <http://www.sgs.com/en/Terms-and-Conditions/Terms-e-Document.aspx>. Attention is drawn to the limitation of liability, indemnification and jurisdiction issues defined therein. Any holder of this document is advised that information contained hereon reflects the Company's findings at the time of its intervention only and within the limits of Client's instructions, if any. The Company's sole responsibility is to its Client and this document does not exonerate parties to a transaction from exercising all their rights and obligations under the transaction documents. This document cannot be reproduced except in full, without prior written approval of the Company. Any unauthorized alteration, forgery or falsification of the content or appearance of this document is unlawful and offenders may be prosecuted to the fullest extent of the law. Unless otherwise stated the results shown in this test report refer only to the sample(s) tested.  
 Attention: To check the authenticity of testing/inspection report & certificate, please contact us at telephone: (86-755) 8307 9443, or email: [CN.Doccheck@sgs.com](mailto:CN.Doccheck@sgs.com)  
 3<sup>rd</sup> Building, No. 589 Yinan Road Xuhui District, Shanghai China 200233 TEL (86-21) 61402593 FAX (86-21) 64953679 [www.sgs.com](http://www.sgs.com)  
 中国·上海·徐汇区宜山路589号3号楼 邮编: 200233 TEL (86-21) 61402594 FAX (86-21) 61158889 [sgs.china@sgs.com](mailto:sgs.china@sgs.com)

Member of the SGS Group (SGS SA)



**Test Report**

No. SHAEC1818655211

Date: 24 Aug 2018

Page 7 of 23

<u>Test Item(s)</u>	<u>Unit</u>	<u>MDL</u>	<u>005</u>
Hexabromocyclododecane (HBCDD)	mg/kg	10	ND

**Polychlorinated Biphenyls (PCBs)**

Test Method : With reference to US EPA 8082A: 2007, analysis was performed by GC-MS

<u>Test Item(s)</u>	<u>CAS NO.</u>	<u>Unit</u>	<u>MDL</u>	<u>005</u>
2,4,4'-Trichlorobiphenyl (PCB 28)	7012-37-5	mg/kg	0.5	ND
2,2',5,5'-Tetrachloro-biphenyl (PCB 52)	35693-99-3	mg/kg	0.5	ND
2,2',4,5,5'-Pentachloro-biphenyl (PCB 101)	37680-73-2	mg/kg	0.5	ND
2,3',4,4',5-Pentachlorobiphenyl (PCB 118)	31508-00-6	mg/kg	0.5	ND
2,2',3,4,4',5'-Hexachloro-biphenyl (PCB 138)	35065-28-2	mg/kg	0.5	ND
2,2',4,4',5,5'-Hexachloro-biphenyl (PCB 153)	35065-27-1	mg/kg	0.5	ND
2,2',3,4,4',5,5'-Heptachlorobiphenyl (PCB 180)	35065-29-3	mg/kg	0.5	ND

**Phthalates Content**

Test Method : With reference to IEC 62321-8:2017, determination of phthalates by GC-MS.

<u>Test Item(s)</u>	<u>CAS NO.</u>	<u>Unit</u>	<u>MDL</u>	<u>005</u>
Diisononyl Phthalate (DINP)	28553-12-0	mg/kg	50	ND
	/68515-48-0			
Di-n-pentyl Phthalates (DnPP)	131-18-0	mg/kg	50	ND
Di-n-octyl Phthalate (DNOP)	117-84-0	mg/kg	50	ND
Diisodecyl Phthalate (DIDP)	26761-40-0	mg/kg	50	ND
	/68515-49-1			
Dihexyl Phthalates (DnHP)	84-75-3	mg/kg	50	ND
1,2-Benzenedicarboxylic acid, di-C7-11-branched and linear alkyl esters(DHNUP)	68515-42-4	mg/kg	50	ND
Bis(2-methoxyethyl) Phthalate (DMEP)	117-82-8	mg/kg	50	ND
Diioheptyl phthalate (DIHP)	71888-89-6	mg/kg	50	ND

**PFOS (Perfluorooctane Sulfonates) and Perfluorooctanoic Acid (PFOA)**

Test Method : With reference to CEN/TS 15968:2010, analysis was performed by LC-MS.



Unless otherwise agreed in writing, this document is issued by the Company subject to its General Conditions of Service printed overleaf, available on request or accessible at <http://www.sgs.com/en/Terms-and-Conditions.aspx> and, for electronic format documents, subject to Terms and Conditions for Electronic Documents at <http://www.sgs.com/en/Terms-and-Conditions/Terms-e-Documents.aspx>. Attention is drawn to the limitation of liability, indemnification and jurisdiction issues defined therein. Any holder of this document is advised that information contained hereon reflects the Company's findings at the time of its intervention only and within the limits of Client's instructions, if any. The Company's sole responsibility is to its Client and this document does not exonerate parties to a transaction from exercising all their rights and obligations under the transaction documents. This document cannot be reproduced except in full, without prior written approval of the Company. Any unauthorized alteration, forgery or falsification of the content or appearance of this document is unlawful and offenders may be prosecuted to the fullest extent of the law. Unless otherwise stated the results shown in this test report refer only to the sample(s) tested.

Attention: To check the authenticity of testing/inspection report & certificate, please contact us at telephone: (86-755) 8307 1443, or email: [CN.Doccheck@sgs.com](mailto:CN.Doccheck@sgs.com)

3<sup>rd</sup> Bldg, No. 888 Yunnan Road, Xuhui District, Shanghai, China 200233 | E&E (86-21) 61402593 | E&E (86-21) 64953679 | [www.sgs.com.cn](http://www.sgs.com.cn)  
 中国·上海·徐汇区宜山路888号3号楼 邮编: 200233 | IHL (86-21) 61402594 | IHL (86-21) 61159889 | [e.sgs.china@sgs.com](mailto:e.sgs.china@sgs.com)

Member of the SGS Group (SGSSA)





Test Report

No. SHAEC1818655211

Date: 24 Aug 2018

Page 8 of 23

Test Item(s)	Limit	Unit	MDL	005
Perfluorooctane Sulfonates (PFOS) <sup>^</sup>	1000	mg/kg	10	ND
Perfluorooctanoic Acid (PFOA)	-	mg/kg	10	ND

Notes :

- (1) Max. limit specified by commission regulation (EU) No. 757/2010 amending regulation (EC) No 850/2004.
- (2) <sup>^</sup> PFOS refer to Perfluorooctanesulfonic acid and its derivatives including Perfluorooctanesulfonic acid, Perfluorooctane sulfonamide, N-Methylperfluorooctane sulfonamide, N-Ethylperfluorooctane sulfonamide, N-Methylperfluorooctane sulfonamidoethanol and N-Ethylperfluorooctane sulfonamidoethanol.



Unless otherwise agreed in writing, this document is issued by the Company subject to its General Conditions of Service printed overleaf, available on request or accessible at <http://www.sgs.com/en/Terms-and-Conditions.aspx> and, for electronic format documents, subject to Terms and Conditions for Electronic Documents at <http://www.sgs.com/en/Terms-and-Conditions/Terms-e-Documents.aspx>. Attention is drawn to the limitation of liability, indemnification and jurisdiction issues defined therein. Any holder of this document is advised that information contained hereon reflects the Company's findings at the time of its intervention only and within the limits of Client's instructions, if any. The Company's sole responsibility is to its Client and this document does not exonerate parties to a transaction from exercising all their rights and obligations under the transaction documents. This document cannot be reproduced except in full, without prior written approval of the Company. Any unauthorized alteration, forgery or falsification of the content or appearance of this document is unlawful and offenders may be prosecuted to the fullest extent of the law. Unless otherwise stated the results shown in this test report refer only to the sample(s) tested.

Attention: To check the authenticity of testing (inspection report & certificate), please contact us at telephone: (86-733) 8307 1443, or email: [CN.Doccheck@sgs.com](mailto:CN.Doccheck@sgs.com)

3<sup>rd</sup> Bldg, No. 889 Yihan Road Xuhui District, Shanghai, China 200233 TEL (86-21) 61402583 FAX (86-21) 614953679 [www.sgs.com](http://www.sgs.com)  
 中国·上海·徐汇区宜山路889号3号楼 邮编: 200233 TEL (86-21) 61402584 FAX (86-21) 61158889 [sgs.china@sgs.com](mailto:sgs.china@sgs.com)

Member of the SGS Group (SGS SA)



Test Report

No. SHAEC1818655211

Date: 24 Aug 2018

Page 9 of 23

**ATTACHMENTS**

**Pb/Cd/Hg/Cr<sup>6+</sup>/PBBs/PBDEs Testing Flow Chart**

- 1) Name of the person who made testing: Meria Jin/Gary Xu/ Xiaolong Yang/Sielina Song
- 2) Name of the person in charge of testing: Jan Shi/Myra Ma/Luna Xu/Shara Wang
- 3) These samples were dissolved totally by pre-conditioning method according to below flow chart. (Cr<sup>6+</sup> and PBBs/PBDEs test method excluded)

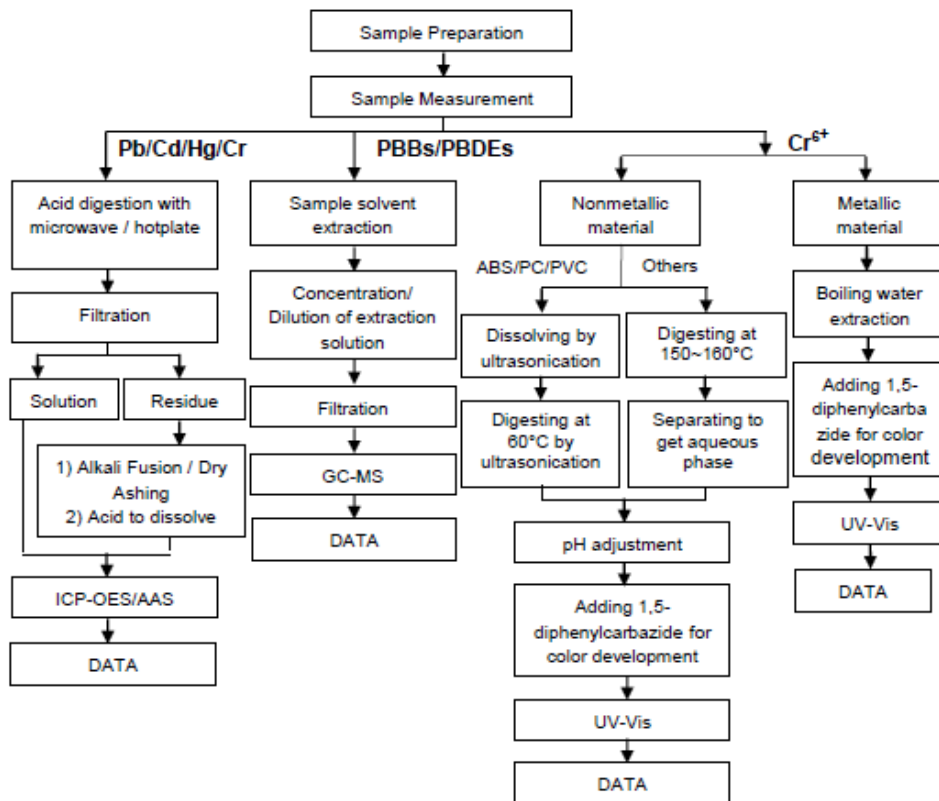

Unless otherwise agreed in writing, this document is issued by the Company subject to its General Conditions of Service printed overleaf, available on request or accessible at <http://www.sgs.com/en/Terms-and-Conditions.aspx> and, for electronic format documents, subject to Terms and Conditions for Electronic Documents at <http://www.sgs.com/en/Terms-and-Conditions/Forms/Terms-e-Documents.aspx>. Attention is drawn to the limitation of liability, indemnification and jurisdiction issues defined therein. Any holder of this document is advised that information contained hereon reflects the Company's findings at the time of its intervention only and within the limits of Client's instructions, if any. The Company's sole responsibility is to its Client and this document does not exonerate parties to a transaction from exercising all their rights and obligations under the transaction documents. This document cannot be reproduced except in full, without prior written approval of the Company. Any unauthorized alteration, forgery or falsification of the content or appearance of this document is unlawful and offenders may be prosecuted to the fullest extent of the law. Unless otherwise stated the results shown in this test report refer only to the sample(s) tested.

Attention: To check the authenticity of testing (inspection report & certificate, please contact us at telephone: (86-755) 8307 1443, or email: [CN.Doccheck@sgs.com](mailto:CN.Doccheck@sgs.com)

3<sup>rd</sup> Building, No. 889 Yishan Road, Xuhui District, Shanghai China 200233 TEL: (86-21) 61402553 FAX: (86-21) 64853679 [www.sgs.com](http://www.sgs.com) cn  
 中国·上海·徐汇区宜山路889号3号楼 邮编: 200233 TEL: (86-21) 61402594 FAX: (86-21) 61158889 [sgs.china@sgs.com](mailto:sgs.china@sgs.com)

Member of the SGS Group (SGS SA)



Test Report

No. SHAEC1818655211

Date: 24 Aug 2018

Page 10 of 23

**ATTACHMENTS**

**Phthalates Testing Flow Chart**

- 1) Name of the person who made testing: Sherlock Gao
- 2) Name of the person in charge of testing: Jessy Huang

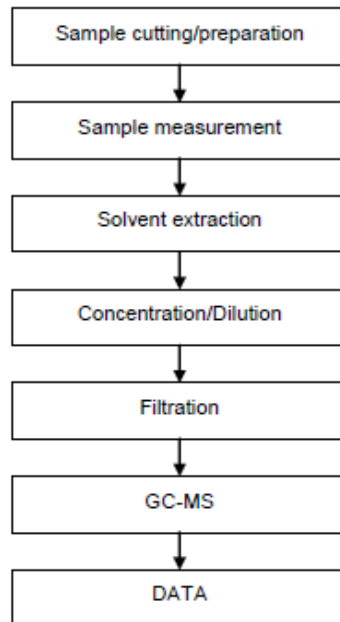

Unless otherwise agreed in writing, this document is issued by the Company subject to its General Conditions of Service printed overleaf, available on request or accessible at <http://www.sgs.com/en/Terms-and-Conditions.aspx> and, for electronic format documents, subject to Terms and Conditions for Electronic Documents at <http://www.sgs.com/en/Terms-and-Conditions/Terms-e-Document.aspx>. Attention is drawn to the limitation of liability, indemnification and jurisdiction issues defined therein. Any holder of this document is advised that information contained hereon reflects the Company's findings at the time of its intervention only and within the limits of Client's instructions, if any. The Company's sole responsibility is to its Client and this document does not exonerate parties to a transaction from exercising all their rights and obligations under the transaction documents. This document cannot be reproduced except in full, without prior written approval of the Company. Any unauthorized alteration, forgery or falsification of the content or appearance of this document is unlawful and offenders may be prosecuted to the fullest extent of the law. Unless otherwise stated the results shown in this test report refer only to the sample(s) tested.  
 Attention: To check the authenticity of testing inspection report & certificate, please contact us at telephone: (86-755) 8367 1443, or email: [CN.Doccheck@sgs.com](mailto:CN.Doccheck@sgs.com)

SGS CST (Shanghai) Technical Services (Shanghai) Co., Ltd.  
 Testing Center (China) Service

3<sup>rd</sup> Building, No. 888 Yixian Road, Xuhui District, Shanghai, China 200233 TEL (86-21) 61402553 FAX (86-21) 64853679 [www.sgs.com.cn](http://www.sgs.com.cn)  
 中国·上海·徐汇区宜山路888号3号楼 邮编: 200233 TEL (86-21) 61402594 FAX (86-21) 61158889 [sgs.china@sgs.com](mailto:sgs.china@sgs.com)

Member of the SGS Group (SGS SA)



Test Report

No. SHAEC1818655211

Date: 24 Aug 2018

Page 11 of 23

ATTACHMENTS

HBCDD Testing Flow Chart

- 1) Name of the person who made testing: Gary Xu
- 2) Name of the person in charge of testing: Myra ma

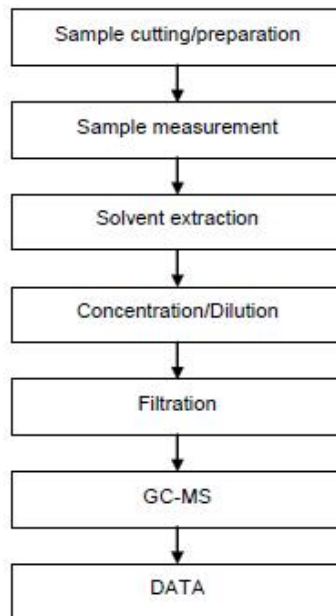

Unless otherwise agreed in writing, this document is issued by the Company subject to its General Conditions of Service printed overleaf, available on request or accessible at <http://www.sgs.com/en/Terms-and-Conditions.aspx> and, for electronic format documents, subject to Terms and Conditions for Electronic Documents at <http://www.sgs.com/en/Terms-and-Conditions/Terms-e-Document.aspx>. Attention is drawn to the limitation of liability, indemnification and jurisdiction issues defined therein. Any holder of this document is advised that information contained hereon reflects the Company's findings at the time of its intervention only and within the limits of Client's instructions, if any. The Company's sole responsibility is to its Client and this document does not exonerate parties to a transaction from exercising all their rights and obligations under the transaction documents. This document cannot be reproduced except in full, without prior written approval of the Company. Any unauthorized alteration, forgery or falsification of the content or appearance of this document is unlawful and offenders may be prosecuted to the fullest extent of the law. Unless otherwise stated the results shown in this test report refer only to the sample(s) tested.

Attention: To check the authenticity of testing/inspection report & certificate, please contact us at telephone: (86-755) 8307 1443, or email: CN.Docscheck@sgs.com

3<sup>rd</sup> Building, No. 889 Yixian Road Xuhui District, Shanghai China 200233 TEL (86-21) 61402553 FAX (86-21) 64853679 www.sgs.com.cn  
 中国·上海·徐汇区宜山路889号3号楼 邮编: 200233 TEL (86-21) 61402594 TEL (86-21) 61158899 e: sgs.china@sgs.com

Member of the SGS Group (SGS SA)



Test Report

No. SHAEC1818655211

Date: 24 Aug 2018

Page 12 of 23

**ATTACHMENTS**

**Halogen Testing (oxygen bomb) Flow Chart**

- 1) Name of the person who made testing: Kevin Xu
- 2) Name of the person in charge of testing: Anne Huang

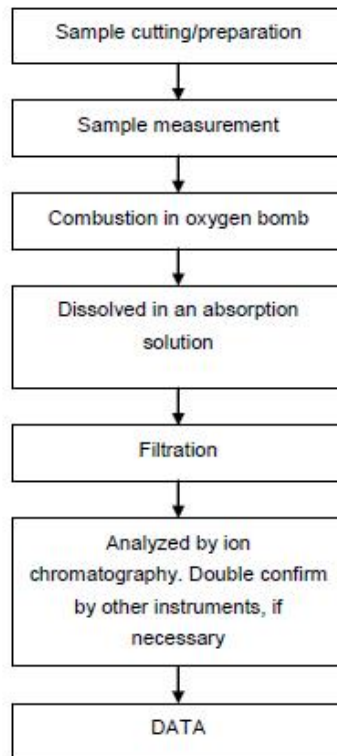

Unless otherwise agreed in writing, this document is issued by the Company subject to its General Conditions of Service printed overleaf, available on request or accessible at <http://www.sgs.com/en/Terms-and-Conditions.aspx> and, for electronic format documents, subject to Terms and Conditions for Electronic Documents at <http://www.sgs.com/en/Terms-and-Conditions/Terms-e-Documents.aspx>. Attention is drawn to the limitation of liability, indemnification and jurisdiction issues defined therein. Any holder of this document is advised that information contained hereon reflects the Company's findings at the time of its intervention only and within the limits of Client's instructions, if any. The Company's sole responsibility is to its Client and this document does not exonerate parties to a transaction from exercising all their rights and obligations under the transaction documents. This document cannot be reproduced except in full, without prior written approval of the Company. Any unauthorized alteration, forgery or falsification of the content or appearance of this document is unlawful and offenders may be prosecuted to the fullest extent of the law. Unless otherwise stated the results shown in this test report refer only to the sample(s) tested.

Attention: To check the authenticity of testing/inspection report & certificate, please contact us at telephone: (86-755) 8307 1443, or email: [CN\\_Goodcheck@sgs.com](mailto:CN_Goodcheck@sgs.com)

SGS (China) Inspection & Testing Services Co., Ltd.  
 3<sup>rd</sup> Building, No. 889 Yishan Road, Xuhui District, Shanghai, China 200233 TEL: (86-21) 61402593 FAX: (86-21) 64893679 www.sgs.com.cn  
 中国·上海·徐汇区宜山路889号3号楼 邮编: 200233 TEL: (86-21) 61402594 FAX: (86-21) 61158889 e: [sgs.china@sgs.com](mailto:sgs.china@sgs.com)

Member of the SGS Group (SGS SA)



Test Report

No. SHAEC1818655211

Date: 24 Aug 2018

Page 13 of 23

**ATTACHMENTS**

**PFOS/PFOA Testing Flow Chart**

- 1) Name of the person who made testing: Richer Yu
- 2) Name of the person in charge of testing: Jessy Huang

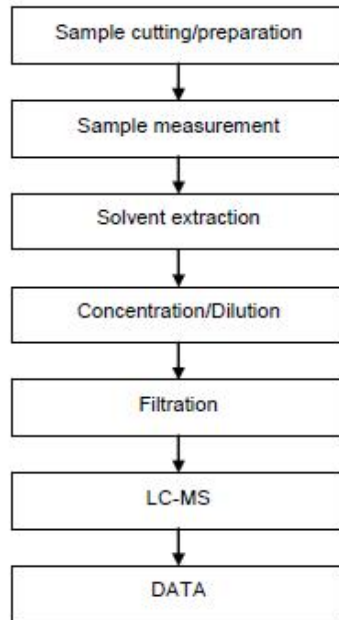

Unless otherwise agreed in writing, this document is issued by the Company subject to its General Conditions of Service printed overleaf, available on request or accessible at <http://www.sgs.com/en/terms-and-conditions.aspx> and, for electronic forest documents, subject to Terms and Conditions for Electronic Documents at <http://www.sgs.com/en/terms-and-conditions/terms-e-documents.aspx>. Attention is drawn to the limitation of liability, indemnification and jurisdiction issues defined therein. Any holder of this document is advised that information contained hereon reflects the Company's findings at the time of its intervention only and within the limits of Client's instructions, if any. The Company's sole responsibility is to its Client and this document does not constitute parties to a transaction from exercising all their rights and obligations under the transaction documents. This document cannot be reproduced except in full, without prior written approval of the Company. Any unauthorized alteration, forgery or falsification of the content or appearance of this document is unlawful and offenders may be prosecuted to the fullest extent of the law. Unless otherwise stated the results shown in this test report refer only to the sample(s) tested.

Attention: To check the authenticity of testing/inspection report & certificate, please contact us at telephones: (86-755) 8307 1443, or email: [CN\\_Document@sgs.com](mailto:CN_Document@sgs.com)

SGS China Inspection & Testing Services Co., Ltd. 3<sup>rd</sup> Building, No. 888 Yehon Road, Xuhui District, Shanghai, China 200233 TEL (86-21) 61402553 FAX (86-21) 64853679 www.sgs.com.cn  
 中国·上海·徐汇区宜山路888号3号楼 邮编: 200233 TEL (86-21) 61402594 FAX (86-21) 61158889 sgs.china@sgs.com

Member of the SGS Group (SGS SA)

**Test Report**

No. SHAEC1818655211

Date: 24 Aug 2018

Page 14 of 23

**ATTACHMENTS**
**PVC Testing Flow Chart**

- 1) Name of the person who made testing: Sally Liang
- 2) Name of the person in charge of testing: Grace Chen

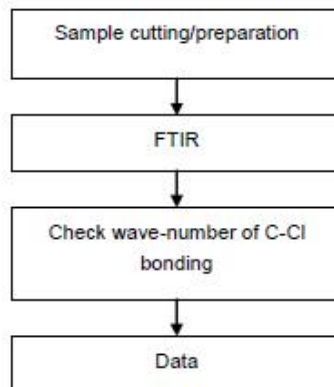

Unless otherwise agreed in writing, this document is issued by the Company subject to its General Conditions of Service printed overleaf, available on request or accessible at <http://www.sgs.com/en/Terms-and-Conditions.aspx> and, for electronic format documents, subject to Terms and Conditions for Electronic Documents at <http://www.sgs.com/en/Terms-and-Conditions/Terms-e-Document.aspx>. Attention is drawn to the limitation of liability, indemnification and jurisdiction issues defined therein. Any holder of this document is advised that information contained hereon reflects the Company's findings at the time of its intervention only and within the limits of Client's instructions, if any. The Company's sole responsibility is to its Client and this document does not exonerate parties to a transaction from exercising all their rights and obligations under the transaction documents. This document cannot be reproduced except in full, without prior written approval of the Company. Any unauthorized alteration, forgery or falsification of the content or appearance of this document is unlawful and offenders may be prosecuted to the fullest extent of the law. Unless otherwise stated the results shown in this test report refer only to the sample(s) tested.

Attention: To check the authenticity of testing/inspection report & certificate, please contact us at telephone: (86-755) 8207 1443, or email: [CN.Doocheek@sgs.com](mailto:CN.Doocheek@sgs.com)

3<sup>rd</sup> Building, No. 888 Yihuan Road, Xuhui District, Shanghai, China 200233 | EME (86-21) 61402553 | ESE (86-21) 64953679 | [www.sgs.com](http://www.sgs.com)  
 中国·上海·徐汇区宜山路888号3号楼 邮编: 200233 | HL (86-21) 61402584 | HL (86-21) 61159889 | [sgs.china@sgs.com](mailto:sgs.china@sgs.com)

Member of the SGS Group (SGS SA)

**Test Report**

No. SHAEC1818655211

Date: 24 Aug 2018

Page 15 of 23

**ATTACHMENTS**
**Organotin Testing Flow Chart**

- 1) Name of the person who made testing: Alex Deng
- 2) Name of the person in charge of testing: Myra ma

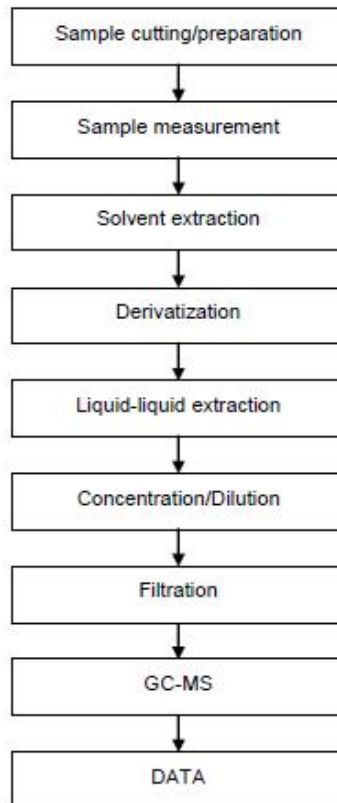

Unless otherwise agreed in writing, this document is issued by the Company subject to its General Conditions of Service printed overleaf, available on request or accessible at <http://www.sgs.com/en/Terms-and-Conditions.aspx> and, for electronic format documents, subject to Terms and Conditions for Electronic Documents at <http://www.sgs.com/en/terms-and-conditions/terms-e-document.aspx>. Attention is drawn to the limitation of liability, indemnification and jurisdiction issues defined therein. Any holder of this document is advised that information contained hereon reflects the Company's findings at the time of its intervention only and within the limits of Client's instructions, if any. The Company's sole responsibility is to its Client and this document does not exonerate parties to a transaction from exercising all their rights and obligations under the transaction documents. This document cannot be reproduced except in full, without prior written approval of the Company. Any unauthorized alteration, forgery or falsification of the content or appearance of this document is unlawful and offenders may be prosecuted to the fullest extent of the law. Unless otherwise stated the results shown in this test report refer only to the sample(s) tested.

Attention: To check the authenticity of testing/inspection report & certificate, please contact us at telephone: (86-733) 8307 9443, or email: [CN\\_Doccheck@sgs.com](mailto:CN_Doccheck@sgs.com)

SGS-CTC (Shanghai) Inspection & Testing Services Co., Ltd. 3<sup>rd</sup> Building, No. 889 Yishan Road, Kuhu District, Shanghai, China 200233 TEL: (86-21) 61402583 FAX: (86-21) 64953679 www.sgs.com.cn  
 中国·上海·徐汇区宜山路889号3号楼 邮编: 200233 TEL: (86-21) 61402584 1HL: (86-21) 61156889 e: [sgs.china@sgs.com](mailto:sgs.china@sgs.com)

Member of the SGS Group (SGS SA)





Test Report

No. SHAEC1818655211

Date: 24 Aug 2018

Page 16 of 23

**ATTACHMENTS**

**PCB/ PCT/ PCN Testing Flow Chart**

- 1) Name of the person who made testing: Jenny Zhang
- 2) Name of the person in charge of testing: Brin Feng

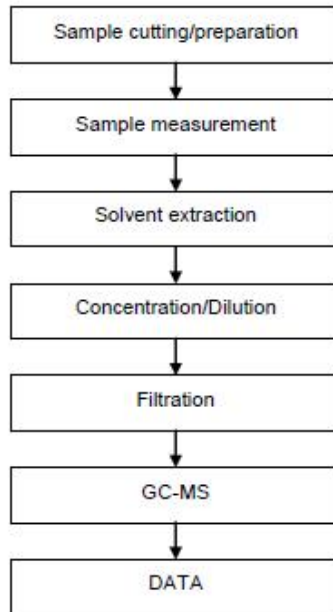

Unless otherwise agreed in writing, this document is issued by the Company subject to its General Conditions of Service printed overleaf, available on request or accessible at <http://www.sgs.com/en/Terms-and-Conditions.aspx> and, for electronic format documents, subject to Terms and Conditions for Electronic Documents at <http://www.sgs.com/en/Terms-and-Conditions/Terms-e-Documents.aspx>. Attention is drawn to the limitation of liability, indemnification and jurisdiction issues defined therein. Any holder of this document is advised that information contained hereon reflects the Company's findings at the time of its intervention only and within the limits of Client's instructions, if any. The Company's sole responsibility is to its Client and this document does not exonerate parties to a transaction from exercising all their rights and obligations under the transaction documents. This document cannot be reproduced except in full, without prior written approval of the Company. Any unauthorized alteration, forgery or falsification of the content or appearance of this document is unlawful and offenders may be prosecuted to the fullest extent of the law. Unless otherwise stated the results shown in this test report refer only to the sample(s) tested.

Attention: To check the authenticity of testing/inspection report & certificate, please contact us at telephone: (86-731) 8307 1443, or email: [CN\\_Doccheck@sgs.com](mailto:CN_Doccheck@sgs.com)  
 SGS Co., Ltd. (Shanghai Inspection & Testing Services) (Co., Ltd.) 13<sup>th</sup> Bldg, No. 889 Yishan Road, Xuhui District, Shanghai, China 200233 TEL (86-21) 61402553 FAX (86-21) 614953679 www.sgs.com.cn  
 中国·上海·徐汇区宜山路889号3号楼 邮编: 200233 TEL (86-21) 61402594 FAX (86-21) 61158889 e [sgs.china@sgs.com](mailto:sgs.china@sgs.com)

Member of the SGS Group (SGS SA)

**Test Report**

No. SHAEC1818655211

Date: 24 Aug 2018

Page 17 of 23

**ATTACHMENTS**
**SCCP/MCCP Testing Flow Chart**

- 1) Name of the person who made testing: Jenny Zhang
- 2) Name of the person in charge of testing: Brin Feng

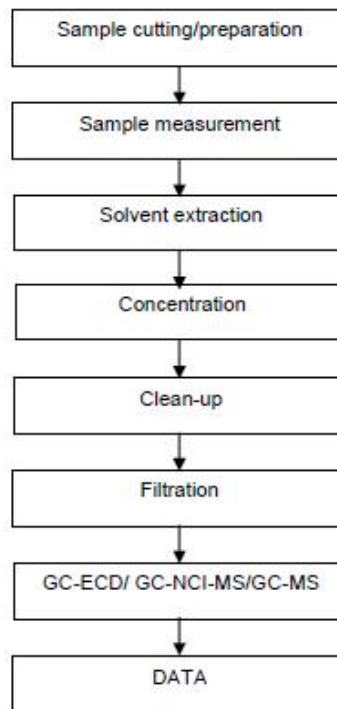

Unless otherwise agreed in writing, this document is issued by the Company subject to its General Conditions of Service printed overleaf, available on request or accessible at <http://www.sgs.com/en/Terms-and-Conditions.aspx> and, for electronic format documents, subject to Terms and Conditions for Electronic Documents at <http://www.sgs.com/en/Terms-and-Conditions/Terms-e-Document.aspx>. Attention is drawn to the limitation of liability, indemnification and jurisdiction issues defined therein. Any holder of this document is advised that information contained hereon reflects the Company's findings at the time of its intervention only and within the limits of Client's instructions, if any. The Company's sole responsibility is to its Client and this document does not exonerate parties to a transaction from exercising all their rights and obligations under the transaction documents. This document cannot be reproduced except in full, without prior written approval of the Company. Any unauthorized alteration, forgery or falsification of the content or appearance of this document is unlawful and offenders may be prosecuted to the fullest extent of the law. Unless otherwise stated the results shown in this test report refer only to the sample(s) tested.

Attention: To check the authenticity of testing/inspection report & certificate, please contact us at telephone: (86-21) 61402584, or email: [CN.Doocheek@sgs.com](mailto:CN.Doocheek@sgs.com)

3<sup>rd</sup> Building, No. 889 Yishan Road, Xuhui District, Shanghai, China 200233 TEL (86-21) 61402583 FAX (86-21) 64853679 [www.sgs.com](http://www.sgs.com)  
 中国·上海·徐汇区宜山路889号3号楼 邮编: 200233 TEL (86-21) 61402584 FAX (86-21) 61158899 [sgs.china@sgs.com](mailto:sgs.china@sgs.com)

Member of the SGS Group (SGS SA)



Test Report

No. SHAEC1818655211

Date: 24 Aug 2018

Page 18 of 23

**ATTACHMENTS**

**Elements Testing Flow Chart**

- 1) Name of the person who made testing: Meria Jin/Sielina Song
- 2) Name of the person in charge of testing: Luna Xu/Jan Shi

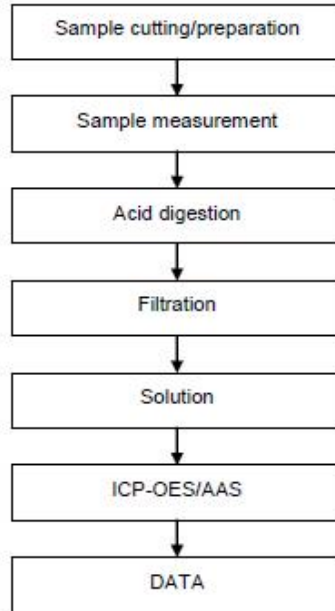

Unless otherwise agreed in writing, this document is issued by the Company subject to its General Conditions of Service printed overleaf, available on request or accessible at <http://www.sgs.com/en/Terms-and-Conditions.aspx> and, for electronic format documents, subject to Terms and Conditions for Electronic Documents at <http://www.sgs.com/en/Terms-and-Conditions/Terms-e-Documents.aspx>. Attention is drawn to the limitation of liability, indemnification and jurisdiction issues defined therein. Any holder of this document is advised that information contained hereon reflects the Company's findings at the time of its intervention only and within the limits of Client's instructions, if any. The Company's sole responsibility is to its Client and this document does not exonerate parties to a transaction from exercising all their rights and obligations under the transaction documents. This document cannot be reproduced except in full, without prior written approval of the Company. Any unauthorized alteration, forgery or falsification of the content or appearance of this document is unlawful and offenders may be prosecuted to the fullest extent of the law. Unless otherwise stated the results shown in this test report refer only to the sample(s) tested.

Attention: To check the authenticity of testing/inspection report & certificate, please contact us at telephone: (86-755) 8107 1442, or email: [CN\\_Docscheck@sgs.com](mailto:CN_Docscheck@sgs.com)

SGS (China) Inspection & Testing Services Co., Ltd. 3<sup>rd</sup> Building, No. 888 Yihuan Road, Xuhui District, Shanghai, China 200233 TEL: (86-21) 61402553 FAX: (86-21) 64853679 [www.sgs.com](http://www.sgs.com)  
 中国·上海·徐汇区宜山路888号3号楼 邮编: 200233 TEL: (86-21) 61402594 FAX: (86-21) 61159889 # [sgs.china@sgs.com](mailto:sgs.china@sgs.com)

Member of the SGS Group (SGS SA)

**Test Report**

No. SHAEC1818655211

Date: 24 Aug 2018

Page 19 of 23

**ATTACHMENTS**
**Red Phosphorus Testing Flow Chart**

- 1) Name of the person who made testing: Sally Liang
- 2) Name of the person in charge of testing: Grace Chen

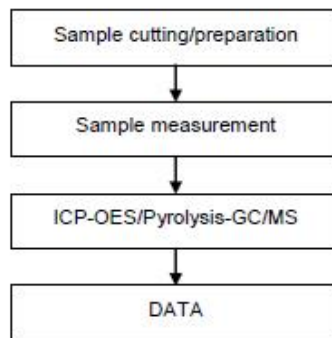

Unless otherwise agreed in writing, this document is issued by the Company subject to its General Conditions of Service printed overleaf, available on request or accessible at <http://www.sgs.com/en/Terms-and-Conditions.aspx> and, for electronic format documents, subject to Terms and Conditions for Electronic Documents at <http://www.sgs.com/en/Terms-and-Conditions/Terms-e-Document.aspx>. Attention is drawn to the limitation of liability, indemnification and jurisdiction issues defined therein. Any holder of this document is advised that information contained hereon reflects the Company's findings at the time of its intervention only and within the limits of Client's instructions, if any. The Company's sole responsibility is to its Client and this document does not exonerate parties to a transaction from exercising all their rights and obligations under the transaction documents. This document cannot be reproduced except in full, without prior written approval of the Company. Any unauthorized alteration, forgery or falsification of the content or appearance of this document is unlawful and offenders may be prosecuted to the fullest extent of the law. Unless otherwise stated the results shown in this test report refer only to the sample(s) tested.

Attention: to check the authenticity of testing/inspection report & certificate, please contact us at telephone: (86-755) 8307 9443, or email: CN\_Doccheck@sgs.com

SGS (China) Inspection & Testing Services (Shanghai) Co., Ltd. 3<sup>rd</sup> Building, No. 888 Yifan Road, Xuhui District, Shanghai, China 200233 | E&E (86-21) 61402583 | E&E (86-21) 64863679 | www.sgs.com.cn  
 中国·上海·徐汇区宜山路888号3号楼 邮编: 200233 | HL (86-21) 61402594 | HL (86-21) 61156889 | e: sgs.china@sgs.com

Member of the SGS Group (SGS SA)



Test Report

No. SHAEC1818655211

Date: 24 Aug 2018

Page 20 of 23

ATTACHMENTS

DMF (Dimethyl fumarate) Testing Flow Chart

- 1) Name of the person who made testing: Alex Deng
- 2) Name of the person in charge of testing: Myra ma

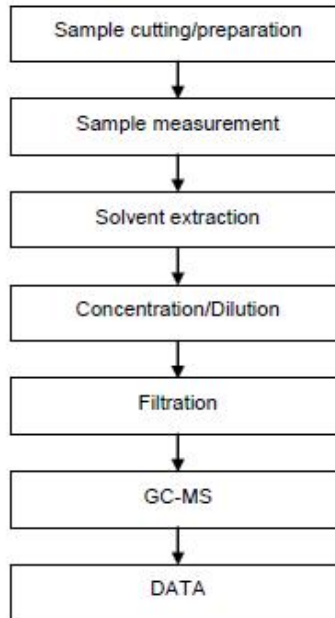

Unless otherwise agreed in writing, this document is issued by the Company subject to its General Conditions of Service printed overleaf, available on request or accessible at <http://www.sgs.com/en/Terms-and-Conditions.aspx> and, for electronic format documents, subject to Terms and Conditions for Electronic Documents at <http://www.sgs.com/en/Terms-and-Conditions/Terms-e-Documents.aspx>. Attention is drawn to the limitation of liability, indemnification and jurisdiction issues defined therein. Any holder of this document is advised that information contained hereon reflects the Company's findings at the time of its intervention only and within the limits of Client's instructions, if any. The Company's sole responsibility is to its Client and this document does not exonerate parties to a transaction from exercising all their rights and obligations under the transaction documents. This document cannot be reproduced except in full, without prior written approval of the Company. Any unauthorized alteration, forgery or falsification of the content or appearance of this document is unlawful and offenders may be prosecuted to the fullest extent of the law. Unless otherwise stated the results shown in this test report refer only to the sample(s) tested.

Attention: To check the authenticity of testing inspection report & certificate, please contact us at telephone: (86-755) 8307 9443, or email: [CN\\_Docscheck@sgs.com](mailto:CN_Docscheck@sgs.com)  
 3<sup>rd</sup> Building, No. 889 Yifan Road, Xuhui District, Shanghai, China 200233 t: ENE (86-21) 61402883 f: ENE (86-21) 64953679 www.sgs.com.cn  
 中国·上海·徐汇区宜山路889号3号楼 邮编: 200233 t: HL (86-21) 61402884 f: HL (86-21) 61158889 e: [sgs.china@sgs.com](mailto:sgs.china@sgs.com)

Member of the SGS Group (SGS SA)

**Test Report**

No. SHAEC1818655211

Date: 24 Aug 2018

Page 21 of 23

**ATTACHMENTS**
**TBBP-A Testing Flow Chart**

- 1) Name of the person who made testing: Gary Xu
- 2) Name of the person in charge of testing: Myra ma

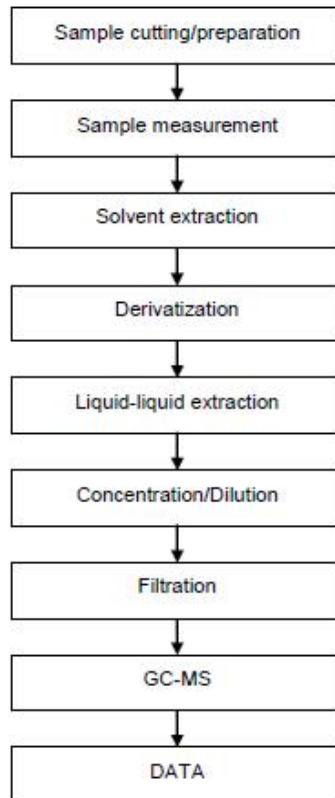

Unless otherwise agreed in writing, this document is issued by the Company subject to its General Conditions of Service printed overleaf, available on request or accessible at <http://www.sgs.com/en/Terms-and-Conditions.aspx> and, for electronic format documents, subject to Terms and Conditions for Electronic Documents at <http://www.sgs.com/en/Terms-and-Conditions/Terms-e-Documents.aspx>. Attention is drawn to the limitation of liability, indemnification and jurisdiction issues defined therein. Any holder of this document is advised that information contained hereon reflects the Company's findings at the time of its intervention only and within the limits of Client's instructions, if any. The Company's sole responsibility is to its Client and this document does not exonerate parties to a transaction from exercising all their rights and obligations under the transaction documents. This document cannot be reproduced except in full, without prior written approval of the Company. Any unauthorized alteration, forgery or falsification of the content or appearance of this document is unlawful and offenders may be prosecuted to the fullest extent of the law. Unless otherwise stated the results shown in this test report refer only to the sample(s) tested.

Attention: To check the authenticity of testing/inspection report & certificate, please contact us at telephone: (86-755) 8387 3443, or email: [CN\\_Deochshh@sgs.com](mailto:CN_Deochshh@sgs.com)

3<sup>rd</sup> Building, No. 889 Yixian Road, Xuhui District, Shanghai, China 200233 TEL: (86-21) 61402553 FAX: (86-21) 64853679 [www.sgs.com.cn](http://www.sgs.com.cn)  
 中国·上海·徐汇区宜山路889号3号楼 邮编: 200233 TEL: (86-21) 61402594 FAX: (86-21) 61158889 [sgs.china@sgs.com](mailto:sgs.china@sgs.com)

Member of the SGS Group (SGS SA)



Test Report

No. SHAEC1818655211

Date: 24 Aug 2018

Page 22 of 23

**ATTACHMENTS**

**BPA Testing Flow Chart**

- 1) Name of the person who made testing: Richer Yu
- 2) Name of the person in charge of testing: Jessy Huang

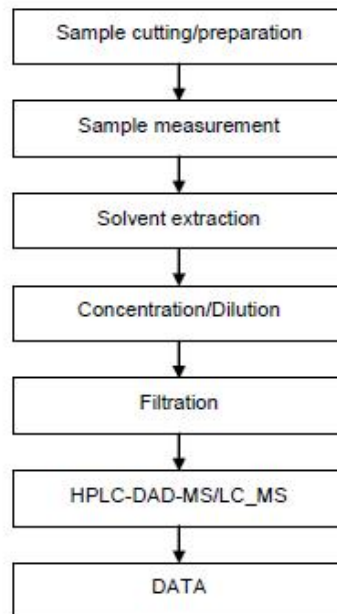

Unless otherwise agreed in writing, this document is issued by the Company subject to its General Conditions of Service printed overleaf, available on request or accessible at <http://www.sgs.com/en/Terms-and-Conditions.aspx> and, for electronic format documents, subject to Terms and Conditions for Electronic Documents at <http://www.sgs.com/en/Terms-and-Conditions/Terms-e-Document.aspx>. Attention is drawn to the limitation of liability, indemnification and jurisdiction issues defined therein. Any holder of this document is advised that information contained hereon reflects the Company's findings at the time of its intervention only and within the limits of Client's instructions, if any. The Company's sole responsibility is to its Client and this document does not exonerate parties to a transaction from exercising all their rights and obligations under the transaction documents. This document cannot be reproduced except in full, without prior written approval of the Company. Any unauthorized alteration, forgery or falsification of the content or appearance of this document is unlawful and offenders may be prosecuted to the fullest extent of the law. Unless otherwise stated the results shown in this test report refer only to the sample(s) tested.

Attention: To check the authenticity of testing inspection report & certificate, please contact us at telephone: (86-755) 8307 1443, or email: [CN.Doccheck@sgs.com](mailto:CN.Doccheck@sgs.com)

3<sup>rd</sup> Building, No. 889 Yinhua Road, Xuhui District, Shanghai, China 200233 TEL: (86-21) 61402553 FAX: (86-21) 64853679 [www.sgs.com.cn](http://www.sgs.com.cn)  
 中国·上海·徐汇区宜山路889号3号楼 邮编: 200233 TEL: (86-21) 61402594 FAX: (86-21) 61156889 [e.sgs.china@sgs.com](mailto:e.sgs.china@sgs.com)

Member of the SGS Group (SGS SA)



Test Report

No. SHAEC1818655211

Date: 24 Aug 2018

Page 23 of 23

Sample photo:



SGS authenticate the photo on original report only

\*\*\* End of Report \*\*\*



Unless otherwise agreed in writing, this document is issued by the Company subject to its General Conditions of Service printed overleaf, available on request or accessible at <http://www.sgs.com/en/Terms-and-Conditions.aspx> and, for electronic format documents, subject to Terms and Conditions for Electronic Documents at <http://www.sgs.com/en/Terms-and-Conditions/Terms-e-Document.aspx>. Attention is drawn to the limitation of liability, indemnification and jurisdiction issues defined therein. Any holder of this document is advised that information contained hereon reflects the Company's findings at the time of its intervention only and within the limits of Client's instructions, if any. The Company's sole responsibility is to its Client and this document does not exonerate parties to a transaction from exercising all their rights and obligations under the transaction documents. This document cannot be reproduced except in full, without prior written approval of the Company. Any unauthorized alteration, forgery or falsification of the content or appearance of this document is unlawful and offenders may be prosecuted to the fullest extent of the law. Unless otherwise stated the results shown in this test report refer only to the sample(s) tested.

Attention: To check the authenticity of testing/inspection report & certificate, please contact us at telephone: (86-755) 8367 1443, or email: [CN\\_Doccheck@sgs.com](mailto:CN_Doccheck@sgs.com)  
 3<sup>rd</sup> Building, No. 889 Yishan Road, Kujia District, Shanghai, China 200233 TEL: (86-21) 61402553 FAX: (86-21) 64953679 [www.sgs.com](http://www.sgs.com)  
 中国·上海·徐汇区宜山路889号3号楼 邮编: 200233 TEL: (86-21) 61402594 FAX: (86-21) 61158899 [sgs.china@sgs.com](mailto:sgs.china@sgs.com)

Member of the SGS Group (SGS SA)