



DATASHEET -Preliminary-

Surface Acoustic Wave Filter

- **Application : LTE B28F / 5G NR n28F DPX**
- **Model : SFX725AUE02**
- **Center Frequency : 780.5 / 725.5 [MHz]**



WISOL CO., LTD.

373-7, GAJANG-DONG, OSAN-SI,
GYEONGGI-DO, KOREA, 447-210

<http://www.wisol.co.kr>

E-mail: sales@wisol.co.kr

1. OUTLINE DRAWING & DIMENSIONS

[Unit: mm]

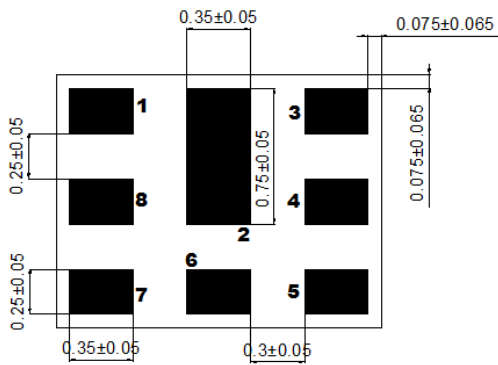
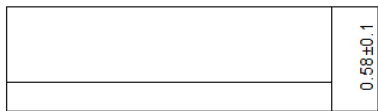
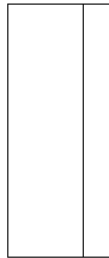
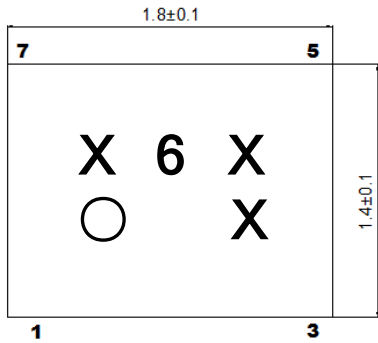

No.	Function
1	Rx Output
3	Tx Input
6	Antenna
2, 4, 5, 7, 8	GND

2. TEST FIXTURE

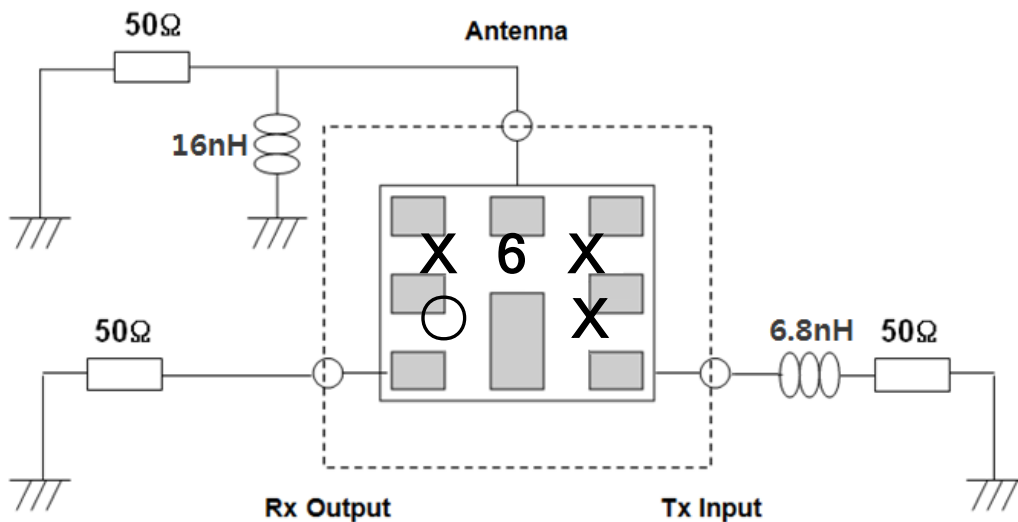

< Top View >

3. PERFORMANCE

3-1. MAXIMUM RATINGS

CHARACTERISTICS	RATINGS	UNITS	NOTES
DC Permissive Voltage	5	V	
Input Power	29(1)	dBm	55 °C, 5000 h
	27.5 (2)	dBm	55 °C, 5000 h
Operating Temperature Range	-30~ +85	°C	
Storage Temperature Range	-40 ~ +85	°C	

- Input Power : +29dBm 5000h +55deg.C (1)
+27.5dBm 5000h +55deg.C (2)
(1) applicable for W-CDMA, SC-FDMA, DFT-s-OFDM
(2) applicable for CP-OFDM

3-2. ELECTRICAL CHARACTERISTICS

3-2-1. TABLE

Ta = -30 ~ +85°C
* PCB loss is de-embedded.

Item	CONDITION [MHz]	UNIT	RATING			NOTE
			Min.	Typ.(25°C)	Max.	
TX → ANTENNA						
Insertion Loss	703.5 ~ 747.5	dB	-	1.7	2.4	+23 to +27deg.C
	703.5 ~ 747.5	dBint	-	1.4	2.4	dBint over 4.5MHz
Inband Ripple	703.5 ~ 747.5	dB	-	1.0	2.0	
TX VSWR	703.5 ~ 747.5	-	-	1.5	2.0	
ANT VSWR	703.5 ~ 747.5	-	-	1.5	2.0	
Absolute Attenuation	10 ~ 670	dB	26	32	-	
	670 ~ 694	dB	12	23	-	
	694 ~ 695	dB	7	19	-	
	695 ~ 698	dB	2.5	10	-	
	758.5 ~ 802.5	dB	40	53	-	
	859 ~ 894	dB	30	36	-	
	1164 ~ 1189	dB	27	33	-	
	1189 ~ 1214	dB	28	34	-	
	1215 ~ 1239.6	dB	28	34	-	
	1406 ~ 1466	dB	30	34	-	
	1559 ~ 1606	dB	30	36	-	
	1710 ~ 1995	dB	30	35	-	
	2010 ~ 2025	dB	29	35	-	
	2109 ~ 2199	dB	26	32	-	
	2109 ~ 2244	dB	26	32	-	
	2400 ~ 2484	dB	24	29	-	
	2500 ~ 2690	dB	23	27	-	
2812 ~ 2982	dB	18	24	-		
3400 ~ 3800	dB	20	25	-		
4900 ~ 5950	dB	18	24	-		
Termination Impedance : Tx / ANTENNA			50Ω (+6.8nH) / 50Ω (//16nH)			

ANTENNA → RX						
Insertion Loss	758.5 ~ 802.5	dB	-	2.0	2.8	+23 to +27deg.C
	758.5 ~ 802.5	dBint	-	1.4	2.4	dBint over 4.5MHz
Inband Ripple	758.5 ~ 802.5	dB	-	1.5	2.0	
ANT VSWR	758.5 ~ 802.5	-	-	1.5	2.0	
RX VSWR	758.5 ~ 802.5	-	-	1.5	2.0	
Absolute Attenuation	10 ~ 699	dB	35	41	-	
	703.5 ~ 747.5	dB	40	54	-	
	814 ~ 824	dB	5	9	-	
	824 ~ 849	dB	10	20	-	
	880 ~ 915	dB	36	42	-	
	1710 ~ 1785	dB	37	43	-	
	1850 ~ 1910	dB	38	44	-	
	1920 ~ 1980	dB	38	44	-	
	2400 ~ 2484	dB	38	44	-	
	2496 ~ 2690	dB	38	44	-	
4900 ~ 5950	dB	23	29	-		
Termination Impedance : ANTENNA / Rx			50Ω (//16nH) / 50Ω			
TX → RX						
Isolation between Rx and Tx	703.5 ~ 747.5	dBint	51	57	-	dBint over 4.5MHz
	758.5 ~ 802.5	dBint	51	57	-	dBint over 4.5MHz

3-2-2. GRAPH

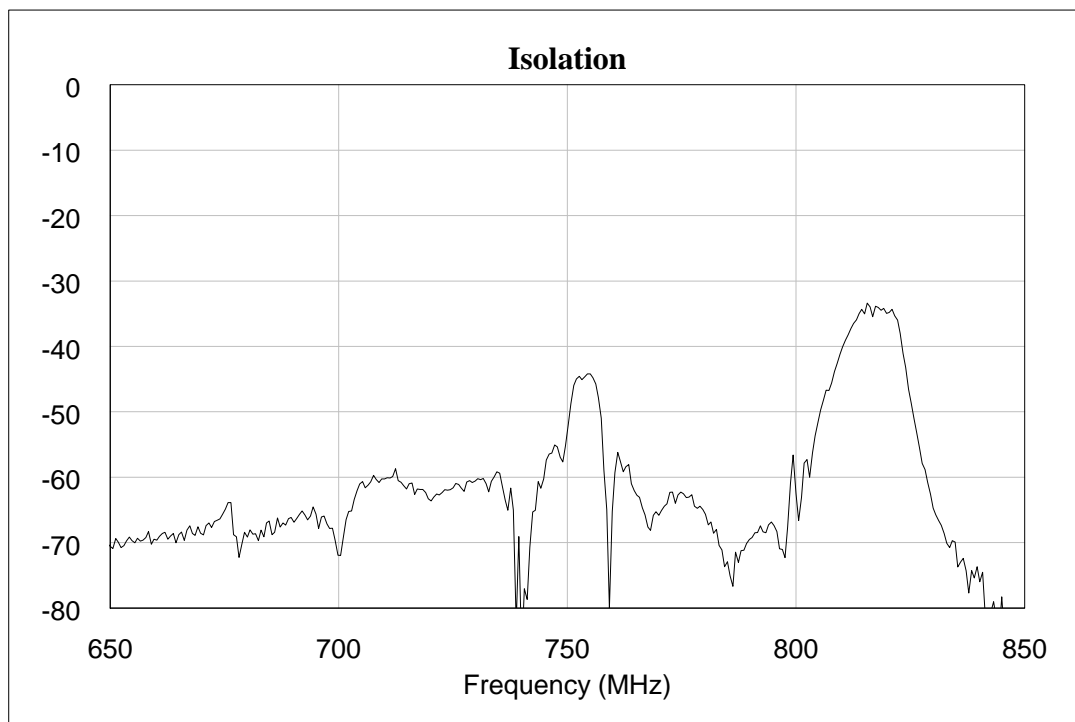
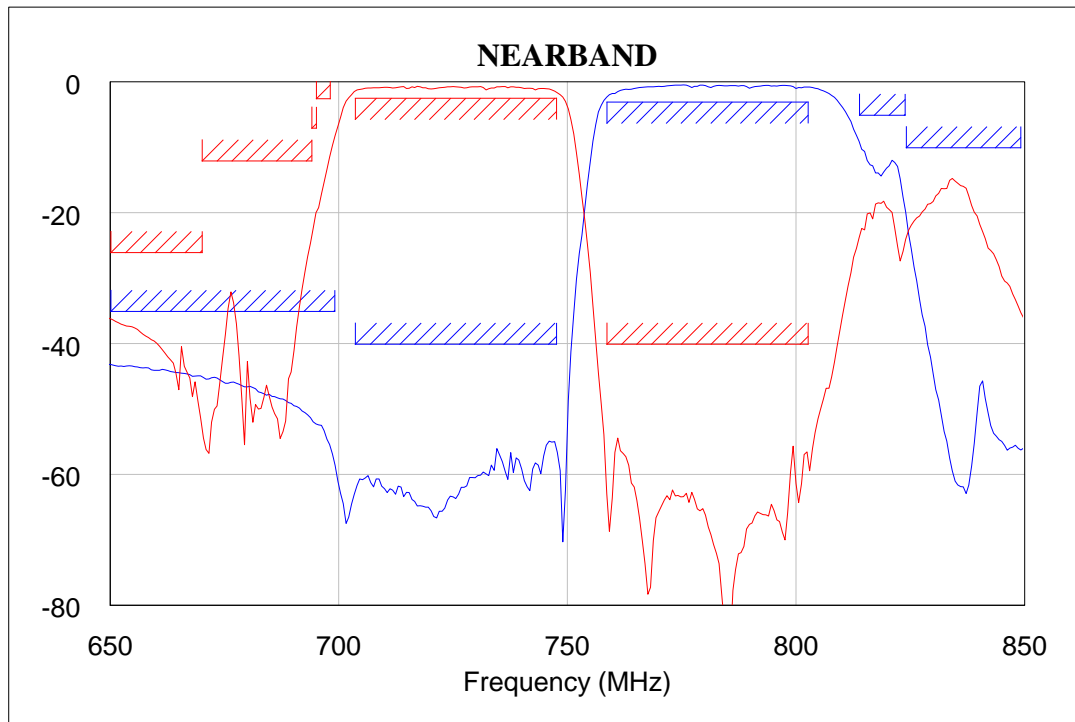

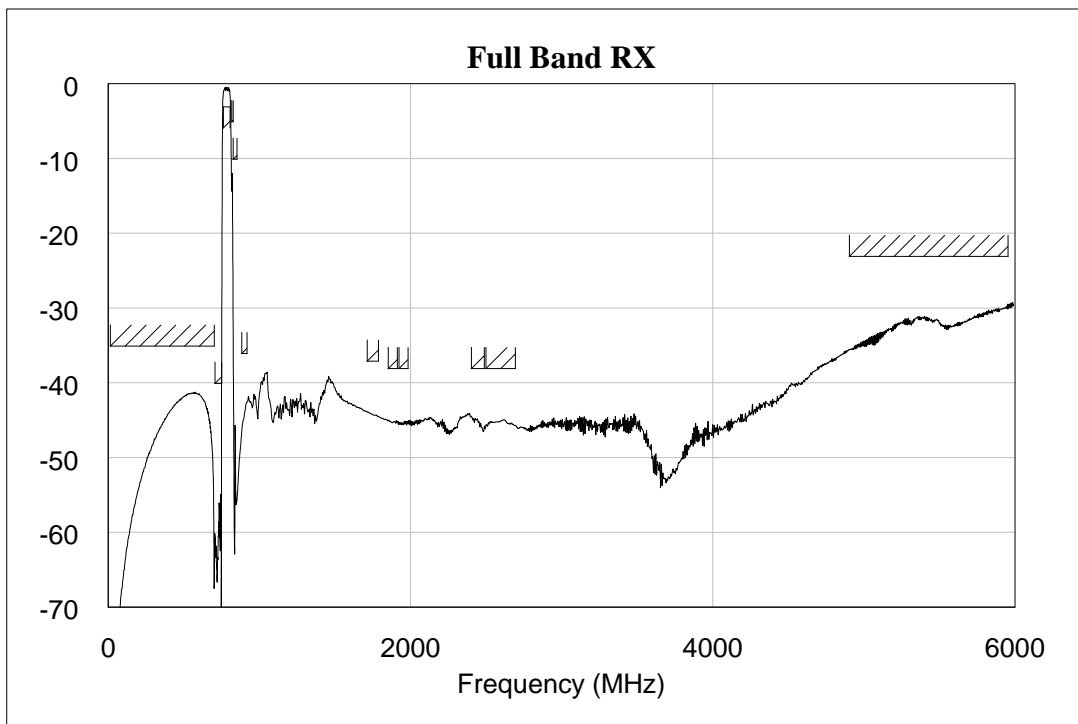
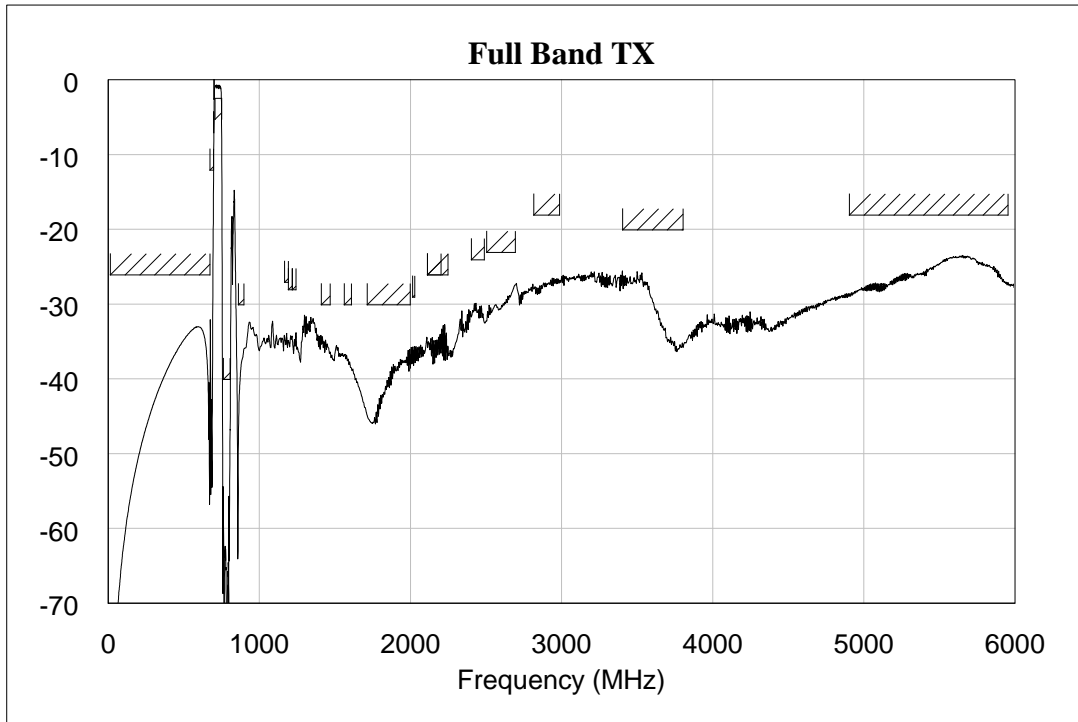

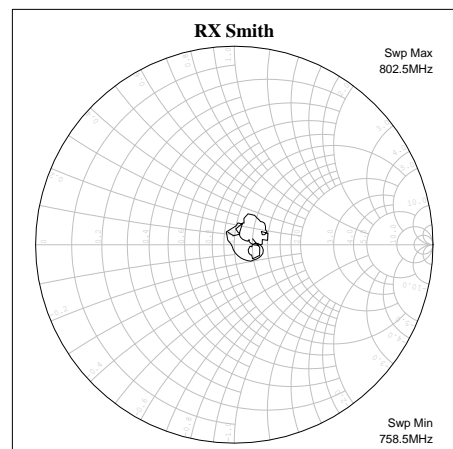
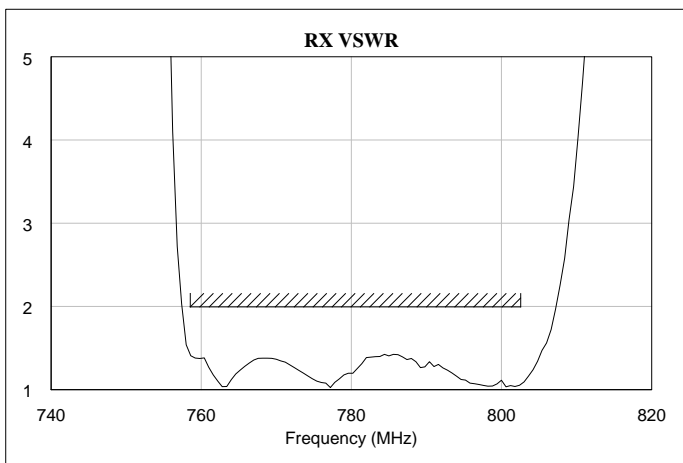
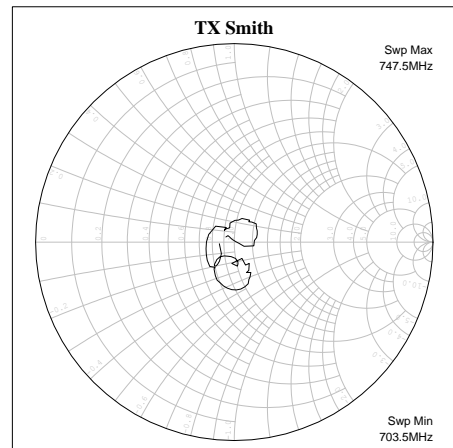
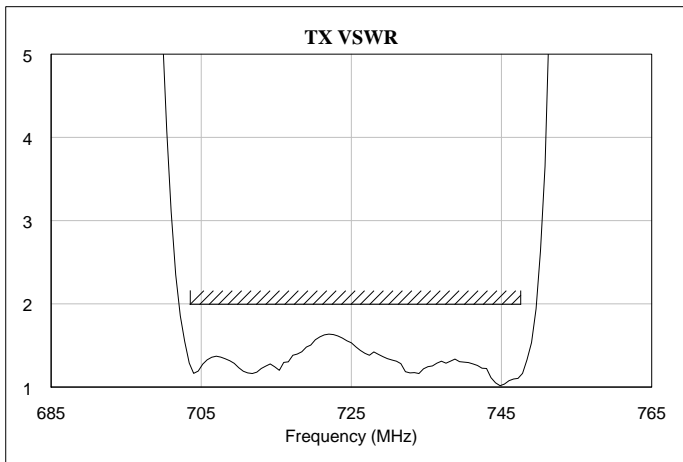
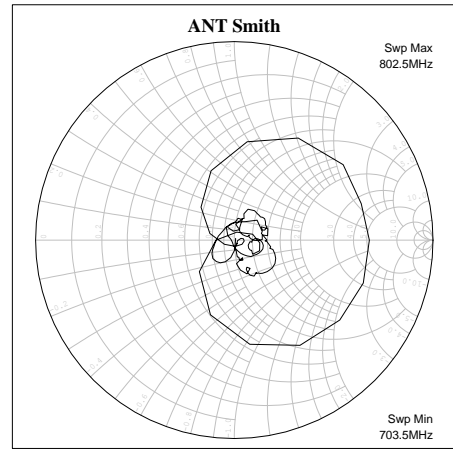
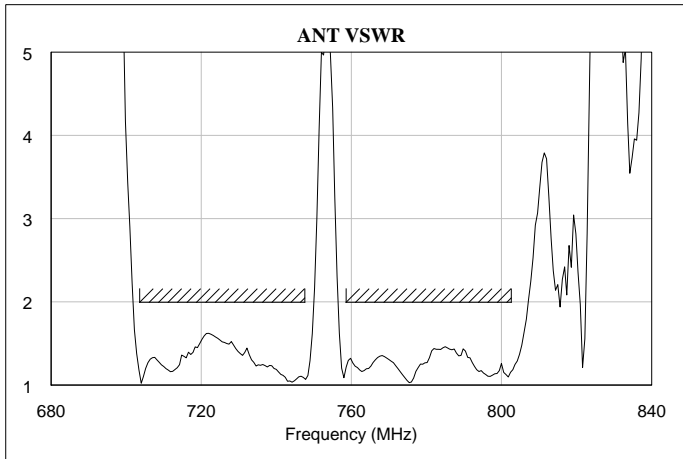

4. PACKING

4-1. DIMENSIONS

- Carrier Tape [Unit: mm]

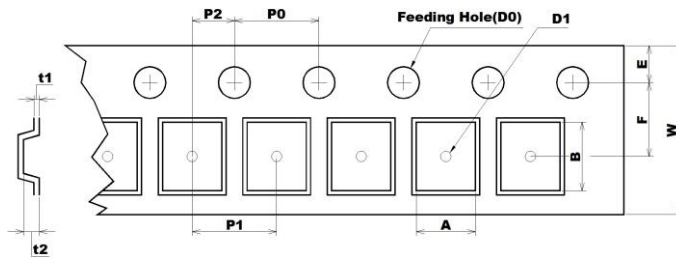

A	B	D0	D1
1.60	2.00	Ø1.55	Ø1.00
+ 0.05	+ 0.05	+ 0.05	MIN
- 0.05	- 0.05	- 0.05	
E	F	P0	P1
1.75	3.50	4.00	4.00
+ 0.10	+ 0.05	+ 0.10	+ 0.10
- 0.10	- 0.05	- 0.10	- 0.10
P2	t1	t2	W
2.00	0.25	0.80	8.00
+ 0.05	+ 0.05	+ 0.05	+ 0.10
- 0.05	- 0.05	- 0.05	- 0.10

- Reel [Unit: mm]

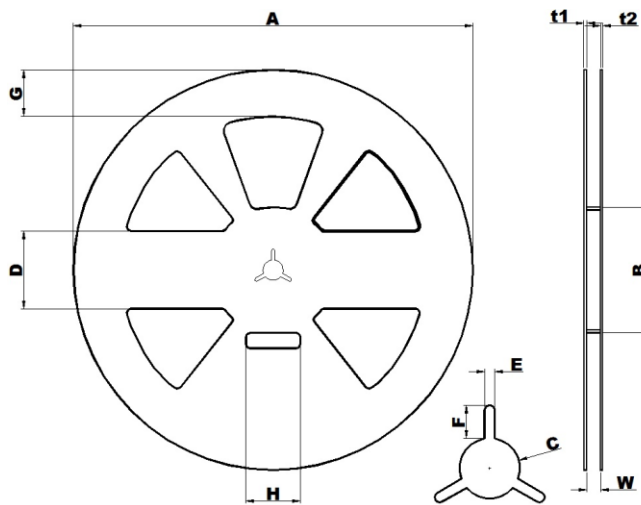

A	B	C	D
Ø258.0	Ø81.0	Ø13.0	50.0
+1.0	+1.0	+0.5	+0.8
-0.5	-1.0	-0.5	-0.8
E	F	G	H
2.2	7.0	30.0	35.0
+0.3	+0.5	+0.8	+1.0
-0.3	-0.5	-0.8	-1.0
t1	t2	W	
1.8	1.5	9.0	
+0.5	+0.5	+1.0	
-0.5	-0.5	-0.5	

- The product shall be packed properly not to be damaged during transportation and storage.

4-2. REELING QUANTITY

10 inch reel: 8,000 pcs/reel

4-3. TAPING STRUCTURE

The tape shall be wound around the reel in direction shown below.

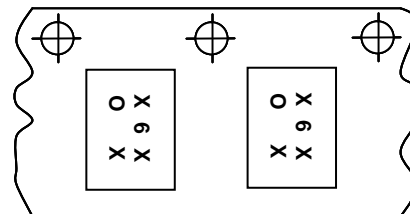
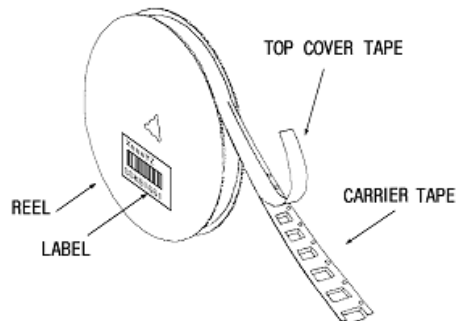

Tape Running direction

