



SPECIFICATION

Surface Acoustic Wave Filter

USER

USER PART No.

WISOL PART No. **SFX718EYJ02**

DOC. No. SMS-51-L-SFT-FS-217

DATE July 1, 2020

REVISION 001

WISOL					
ISSUED BY	Kim, Jin-Hee 	APPROVED BY (R&D)	Ha, Sang-Ki 	APPROVED BY (QC)	Hong, Sang-Dea 
User					
ISSUED BY		CHECKED BY		APPROVED BY	

WISOL CO., LTD.
531-7, Gajang-ro, Osan-si,
Gyeonggi-do, KOREA, 18103
<http://www.wisol.co.kr>

▶ A TABLE OF CONTENTS

1. REVISION HISTORY	3
2. DEFINITION	4
3. PRECAUTIONS	4
4. OUTLINE DRAWING & DIMENSIONS	5
5. MARKING	6
6. PERFORMANCE	7
6-1. MAXIMUM RATINGS	7
6-2. ELECTRICAL CHARACTERISTICS	8
7. RELIABILITY	14
7-1. ENGINEERING SAMPLE FLOW CHART	14
7-2. TEST ITEM & CONDITION	15
8. REFLOW CONDITION	16
9. RECOMMENDED PCB DIMENSIONS	16
10. CAUTION	17
11. PACKING	18
11-1. DIMENSIONS	18
11-2. REELING QUANTITY	19
11-3. TAPING STRUCTURE	19
11-4. INNER BOX(Reel Packing) STRUCTURE	20
11-5. OUTER BOX STRUCTURE	21
12. TAPE SPECIFICATIONS	22
13. RoHS DATA	23
13-1. RAW MATERIAL(EPOXY)	23
13-2. RAW MATERIAL(PACKAGE)	32
13-3. RAW MATERIAL(LT WAFER)	48
13-4. RAW MATERIAL(GOLD WIRE)	57

1. REVISION HISTORY

000	March 24, 2019	All Page	Make specification
001	July 1, 2020	4,7 Page	Update for 5GNR
		20~21 Page	Update for Packing Box
		23~71 Page	Update for RoHS Data

2. DEFINITION

2-1. PART No.

S F X 718 E Y J 02

① ② ③ ④ ⑤ ⑥

No.	EXPLANATION
①	SAW Filter
②	Design Type
③	Center Frequency : TX(718MHz), RX(773MHz)
④	Input:50ohm,Output:50ohm
⑤	Package size: 1.8×1.4mm ²
⑥	Design Revision (02 : Molding Type)

2-2. APPLICATION : LTE B28A, 5GNR n28A Unbalanced Duplexer

2-3. SPEC

ESD Level HBM=300V

3. PRECAUTIONS

3-1. This device should not be used in any type of fluid such as water, oil, organic solvent, etc.

3-2. This is a hermetic device.

MSL(Moisture Sensitive Level) is the '2a' level.

3-3. Ultrasonic cleaning shall be avoided.

3-4. Isopropyl Alcohol and Ethyl Alcohol can be used for cleaning. Contact us before using other cleaning solvents than above

3-5. This is an electrostatic sensitive device.

Please avoid static voltage during operation and storage.

3-6. Sudden change of temperature shall be avoided, deterioration of the characteristics can occur.

3-7. If any malfunction due to designing or manufacturing which is out of specification occurs within one year after the products have been delivered, the maker should exchange the defective products.

4. OUTLINE DRAWING & DIMENSIONS

[Unit: mm]

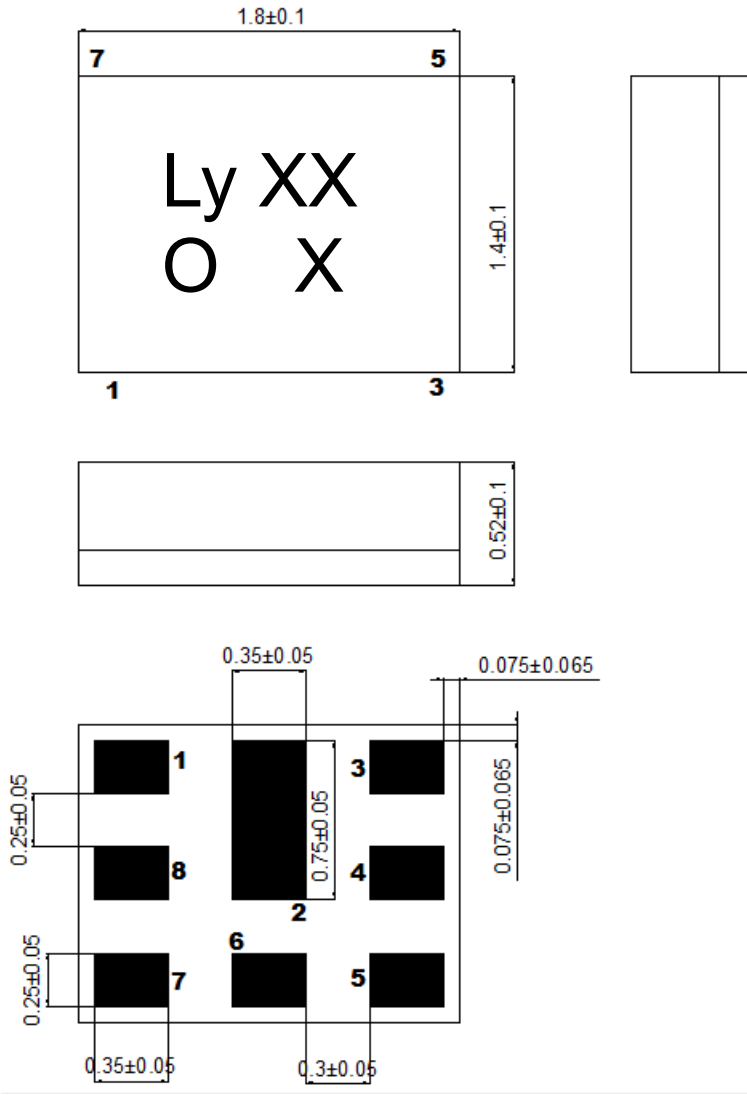

5. MARKING

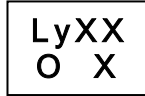

5-1. L y X X

- The 1st 2nd character 'Ly' indicates the model name of SAW Filter SFX718EYJ02.
- The 3rd character 'X' indicates the year and the month of manufacture.

Year	Month											
	1	2	3	4	5	6	7	8	9	10	11	12
2020	1	2	3	4	5	6	7	8	9	A	B	C
2021	D	E	F	G	H	I	J	K	L	M	N	O
2022	P	Q	R	S	T	U	V	W	X	Y	Z	a
2023	1	2	3	4	5	6	7	8	9	A	B	C

※ This rotates by the 3 years.

- The 4th , 5th character 'X' indicates Lot No.

5-2. ○

- This symbol indicates input pin 1.
- This indicates the producing center
 - : China

5-3. Marking : Laser Marking

6. PERFORMANCE

6-1. MAXIMUM RATINGS

CHARACTERISTICS	RATINGS	UNITS	NOTES
DC Permissive Voltage	5	V	
Input Power	30 (1)	dBm	55 °C, 5000 h
	28.5 (2)	dBm	55 °C, 5000 h
Operating Temperature Range	- 20 ~ +85	°C	
Storage Temperature Range	- 40 ~ +85	°C	

- Input Power : +30dBm 5000h +55deg.C (1)
- +28.5dBm 5000h +55deg.C (2)
- (1) applicable for W-CDMA, SC-FDMA, DFT-s-OFDM
- (2) applicable for CP-OFDM

6-2. ELECTRICAL CHARACTERISTICS
6-2-1. TABLE

Ta = -20 ~ +85°C

* PCB loss is de-embedded

Item	CONDITION	UNIT	RATING			Note
	[MHz]		Min.	Typ.(25°C)	Max.	
TX → ANTENNA						
Insertion Loss	703.24-732.76	dB	-	2.0	2.9	
Inband Ripple	703-733	dB	-	0.9	1.8	
VSWR	703-733	-	-	1.6	2.0	
Absolute Attenuation	10-670	dB	25	30	-	
	670-694	dB	28	33	-	
	694-695	dB	23	38	-	
	695-698	dB	5	20	-	
	695-698	dB	7	20	-	+15 to +50degC
	758-788	dB	45	50	-	
	788.0-803.0	dB	15	21	-	
	859.0-894.0	dB	28	31	-	
	1406.0-1466.0	dB	32	37	-	
	1559.0-1563.0	dB	30	36	-	
	1565.42-1573.37	dB	30	35	-	
	1573.37-1577.47	dB	30	35	-	
	1577.47-1585.42	dB	30	35	-	
	1597.55.0-1605.89	dB	30	35	-	
	1805-1880.0	dB	30	33	-	
	2010-2025	dB	28	32	-	
	2109-2199	dB	26	31	-	
	2400-2484	dB	25	29	-	
2812-2932	dB	20	26	-		
4900-5950	dB	20	29	-		
Termination Impedance : Tx / ANT			50Ω(+ 8.7[nH]) / 50Ω(// 7.8 [nH])			

ANTENNA → RX						
Insertion Loss	758.24-787.76	dB	-	1.8	2.6	
Inband Ripple	758-788	dB	-	0.5	1.5	
VSWR	758-788	-	-	1.6	2.1	
Absolute Attenuation	1-703	dB	40	57	-	
	703.24-732.76	dB	50	59	-	
	1710-1785	dB	40	62	-	
	1850-1920	dB	40	61	-	
	1920-2400	dB	40	58	-	
	2400-2500	dB	40	58	-	
	2484-2775	dB	40	58	-	
	2775-2880	dB	40	58	-	
	2800-6000	dB	30	42	-	
Termination Impedance : ANT / Rx			50Ω(// 7.8[nH]) / 50Ω(+ 3[nH])			
TX → RX						
Isolation between Rx and Tx	703.24 ~ 732.76	dB	57	61	-	
	758.24 ~ 787.76	dB	55	58	-	

6-2-2. TEST FIXTURE

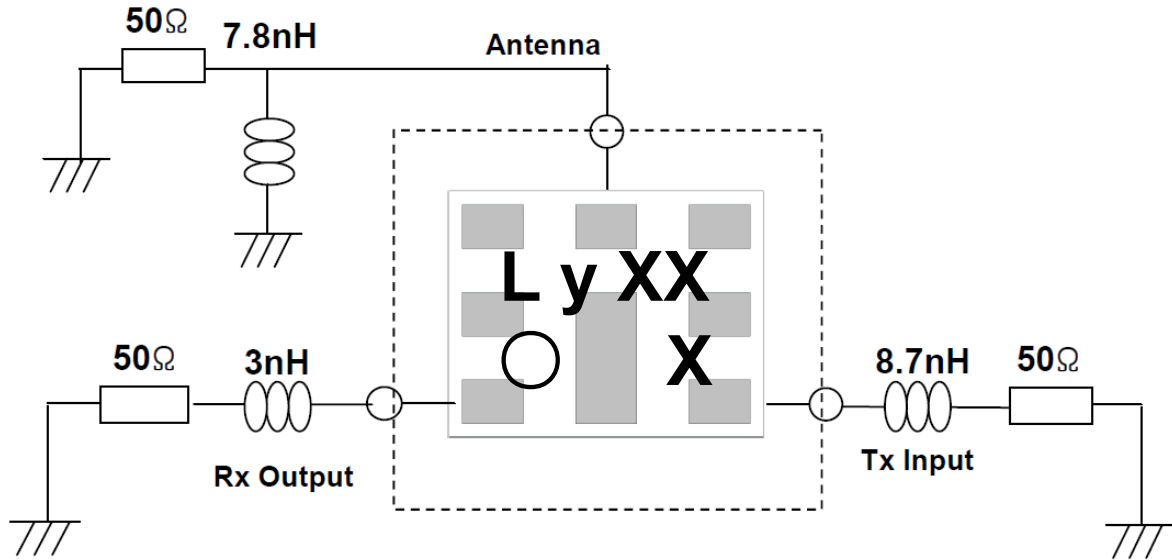

[X-Ray Top View]

6-2-3. GRAPH

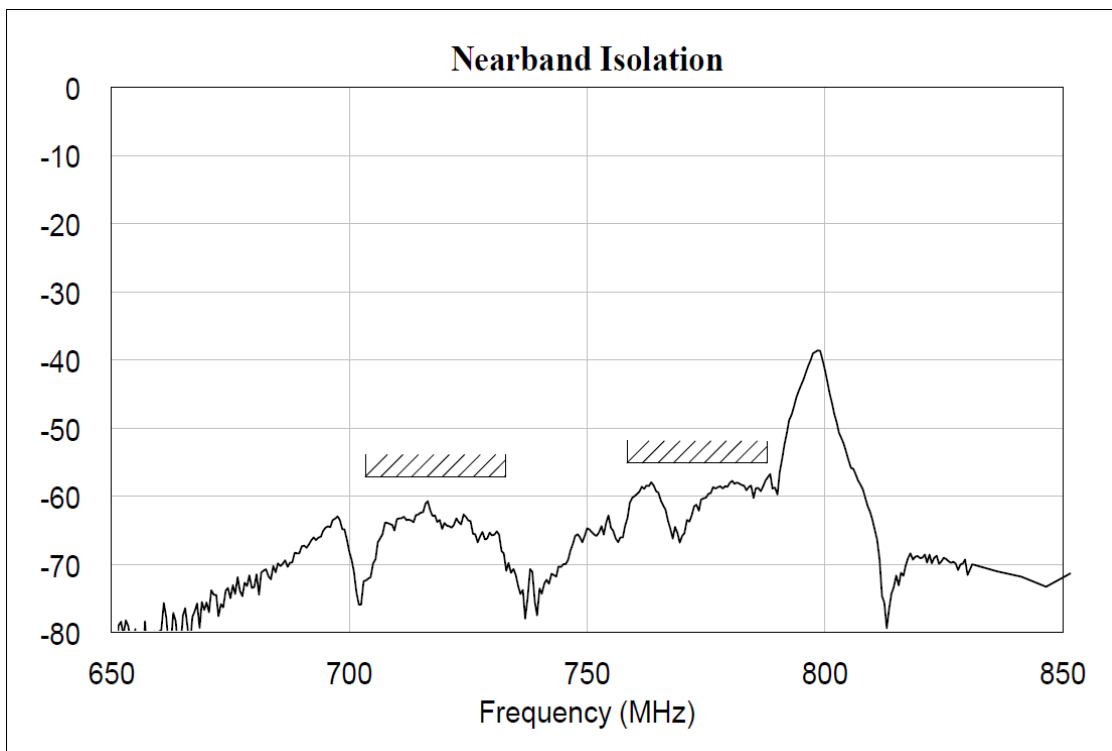
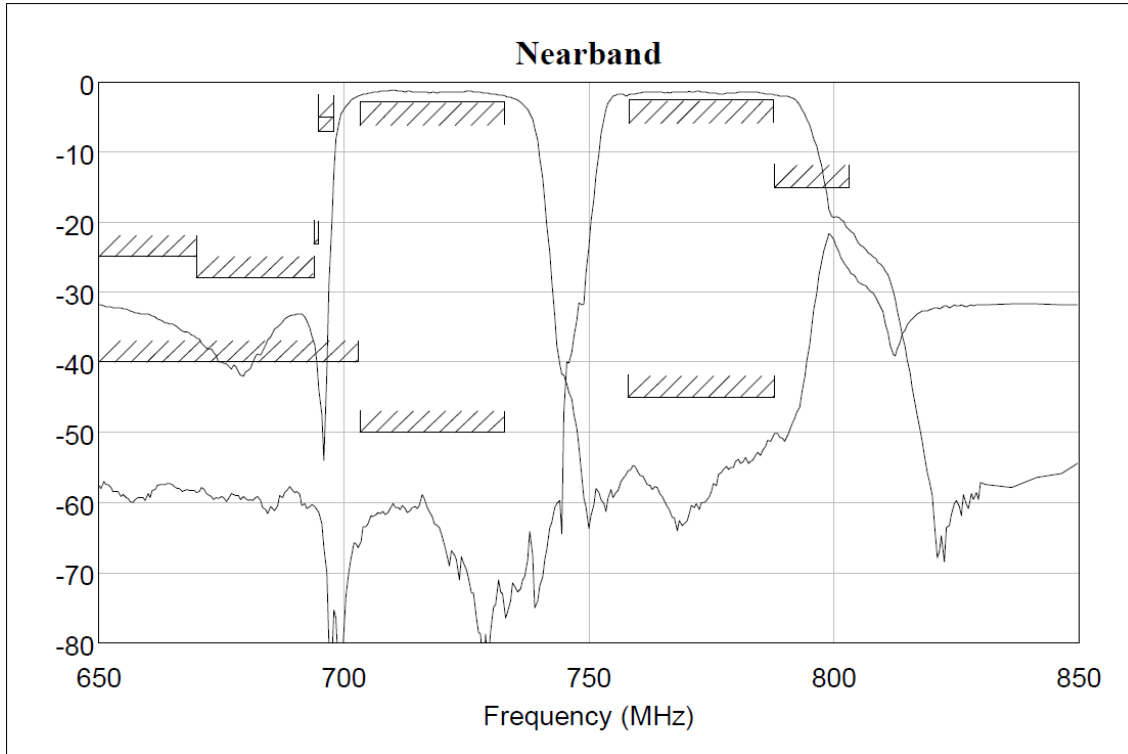

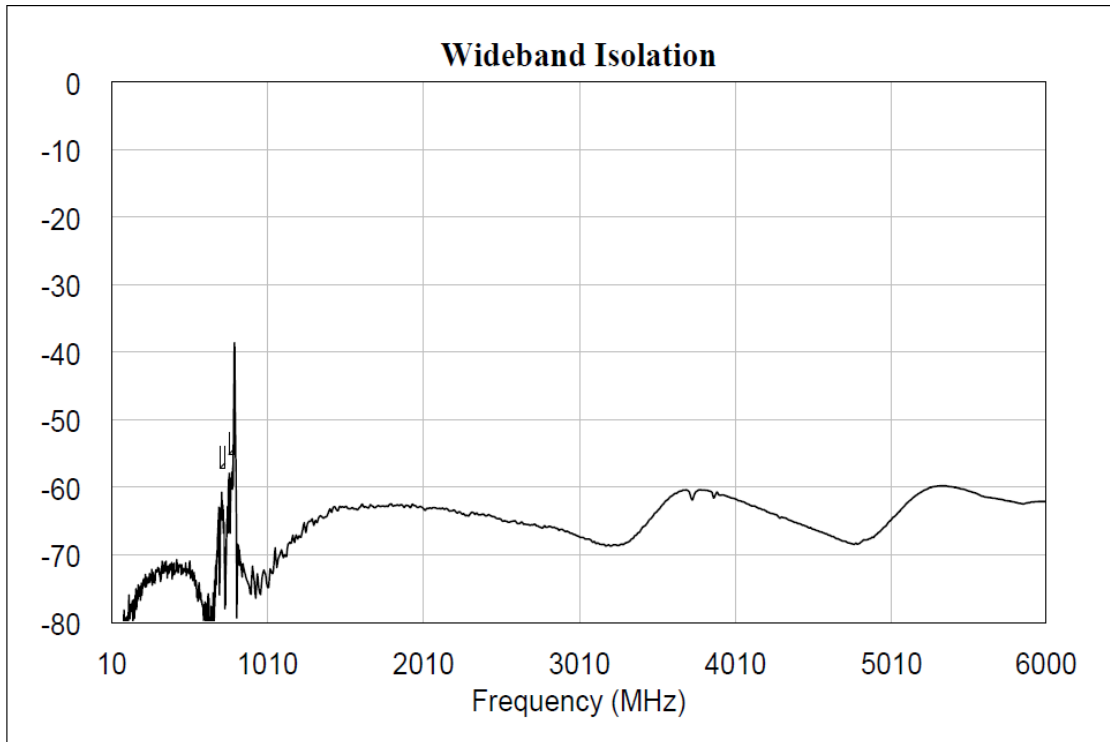
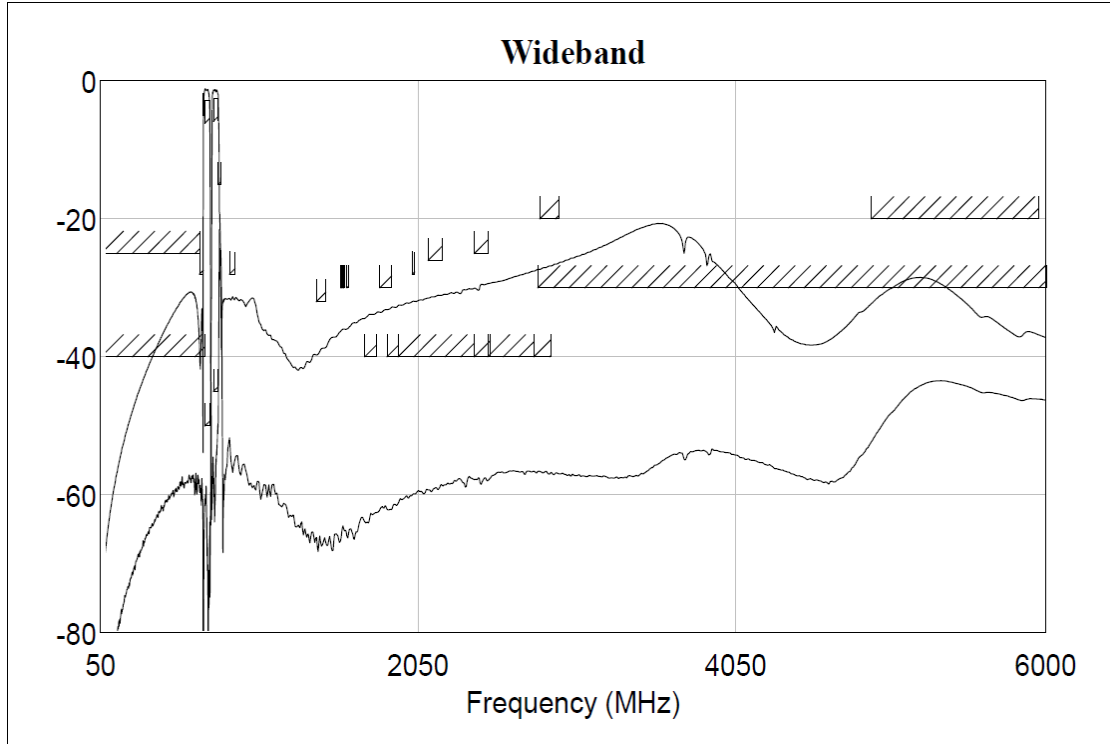

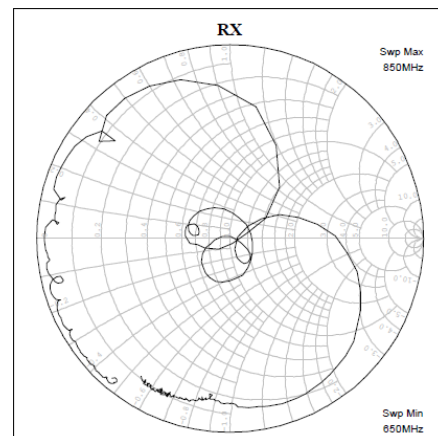
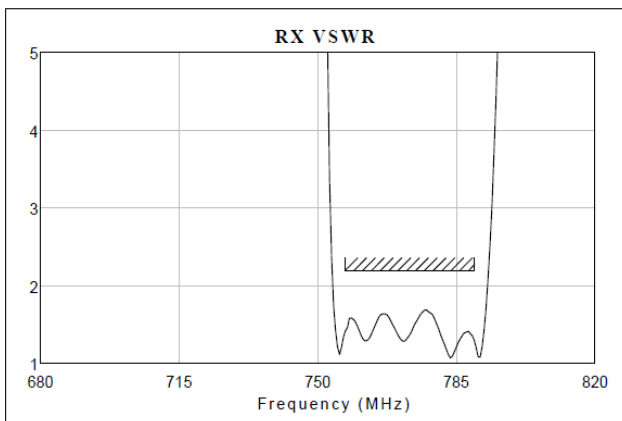
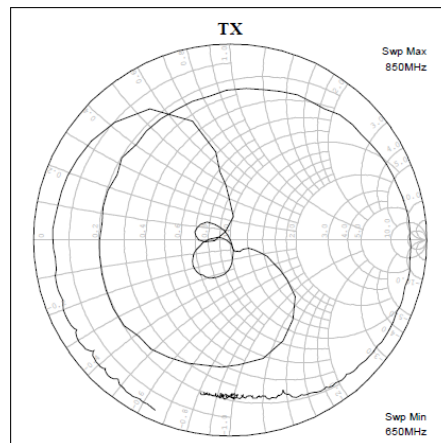
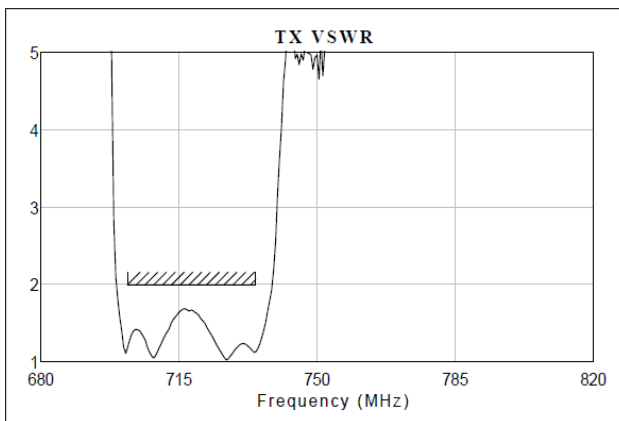
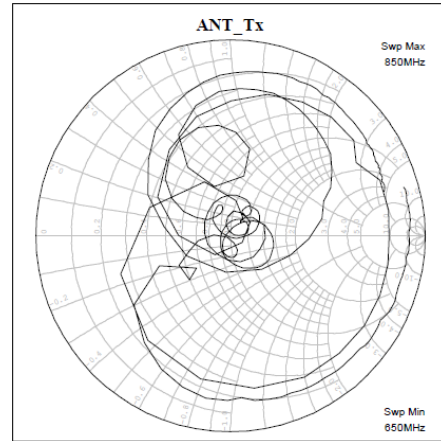
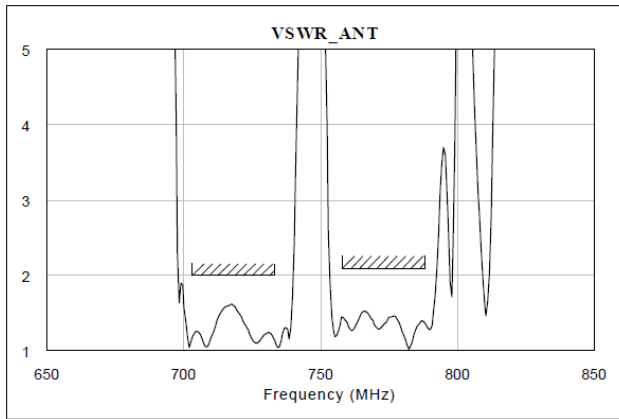

7. RELIABILITY

7-1. ENGINEERING SAMPLE FLOW CHART

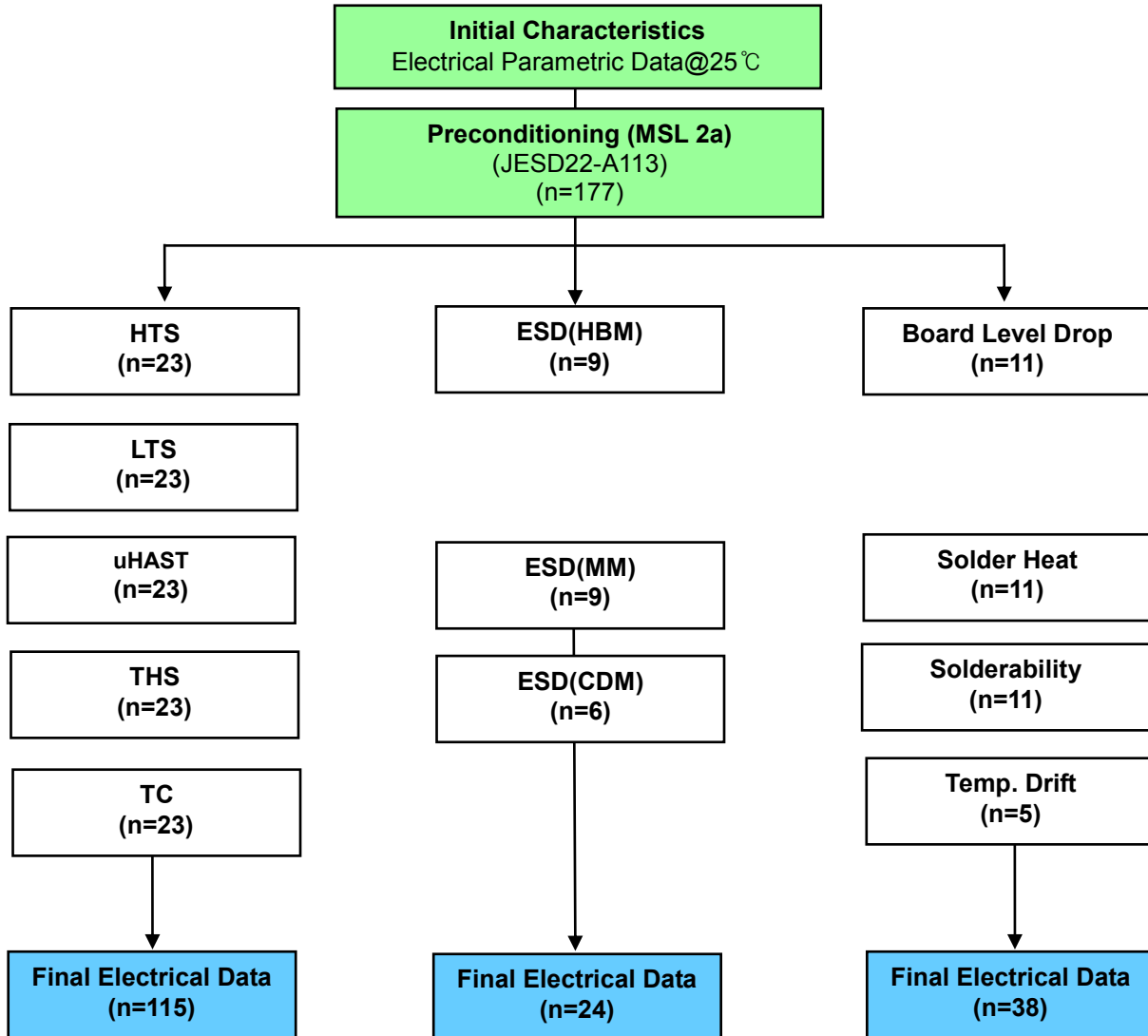

7-2. TEST ITEM & CONDITION

CATEGORY	TEST ITEM	TEST CONDITION	REMARK
Preconditioning		Bake + Soak(MSL or above) + 3X Reflow duration (Soak 60°C 60% 120HR)	JESD22-A113



TEST ITEM	REMARK	TEST CONDITION	Duration
HTS (High Temperature Storage)	JESD22-A103	condition A 125(-0/+10)°C	1000hr
LTS (Low Temperature Storage)	JESD22-A119	A -40(-10/+0)°C	1000hr
uHAST (Unbiased HAST)	JESD22-A118	130°C /85% /33.3psi	96hr
THS (Temperature Humidity Storage)	JESD22-A101	85°C /85% RH	1000hr
TC (Temperature Cycle)	JESD22-A104	Condition B (-55°C /125°C)	500cycle
ESD(HBM)	JESD22-A114	250V or above	-
ESD(MM)	JESD22-A115	No spec but need data	-
ESD(CDM)	JESD22-C101	1.0KV or above	-
Board Level Drop Test	-	120cm(12times), 152cm(19times) total(31times) Steel floor	
Solder Heat Resistance	JESD22-B106C	260°C / 10sec Solder Pore Dipping	10sec
Solderability	JESD22-B102E	235°C/ 3sec Solder Pore Dipping	3sec
Temp Drift		-40°C → +25°C → +125°C	Per Conditions 2HR

8. REFLOW CONDITION

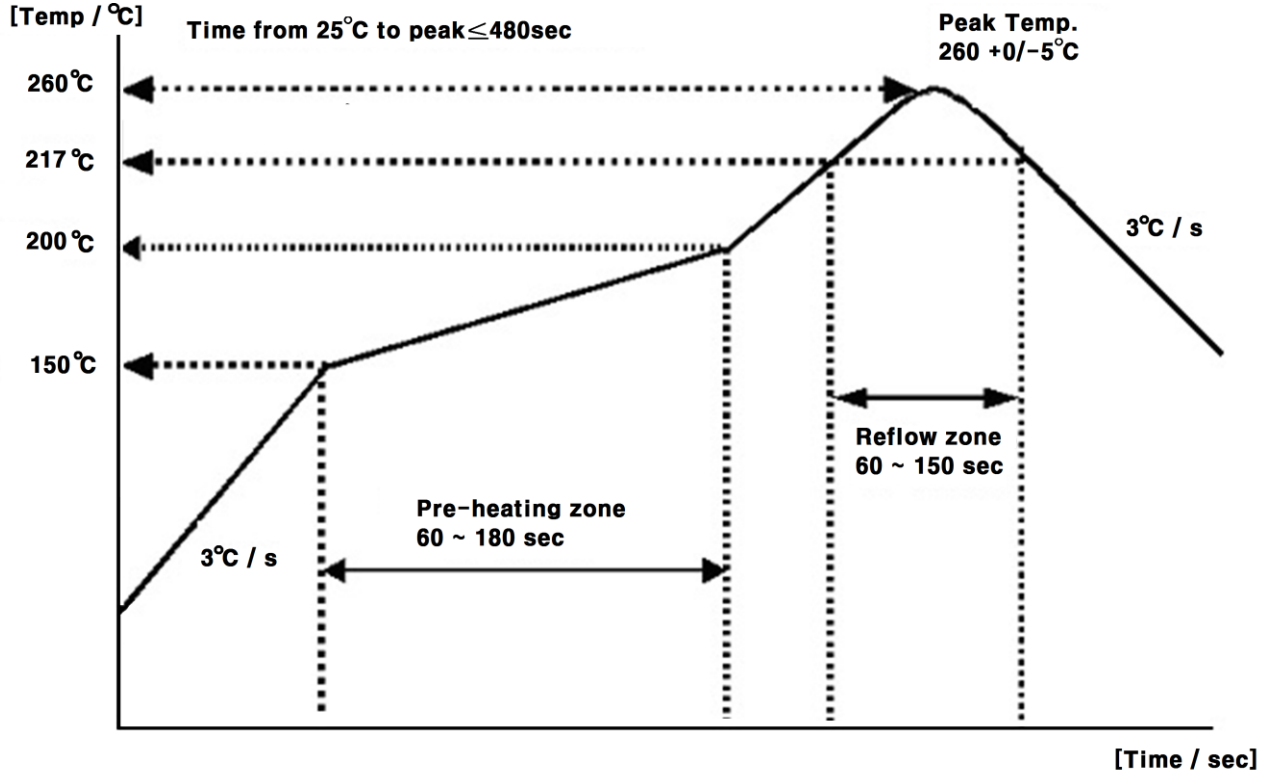

9. RECOMMENDED PCB DIMENSIONS

[unit : mm]

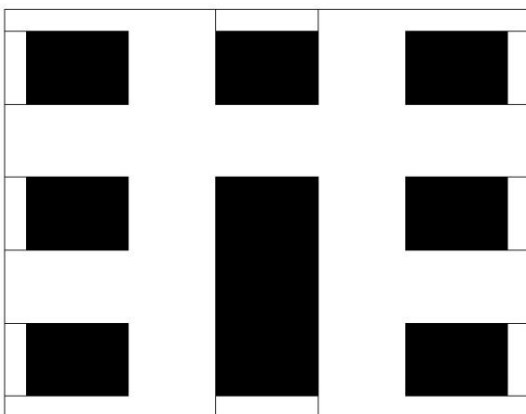

[SAW, X-ray Top view]

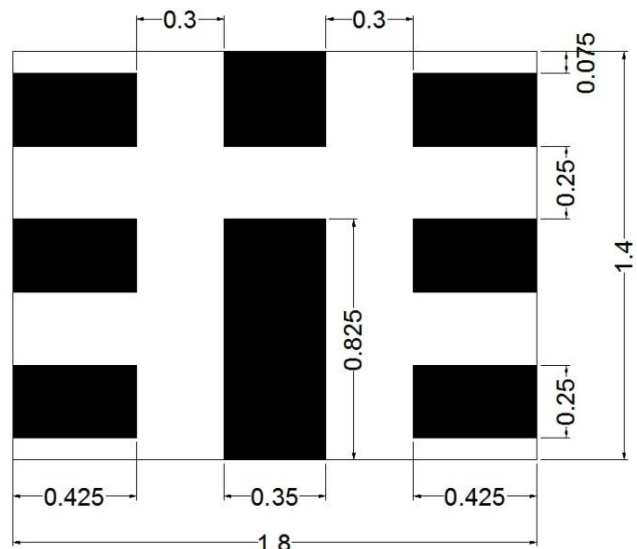

[PCB, X-ray Top view]

10. CAUTION

Moisture Sensitivity Device Caution (MSL LEVEL=2a)

1. Calculated shelf life in sealed bag : 12 month at < 40℃ and < 90% relative Humidity(RH)
 2. Peak package body temperature : **260℃**
 3. After bag is opened, devices that will be subjected to reflow solder or other high temperature process must be
 - (a) Mounted within : 672 hours of factory conditions ≤30℃/60% RH, or
 - (b) Stored per J-STD-033
 4. Device require bake, before mounting, if :
 - (a) Humidity Indicator Card reads > 60% when read at 23±5℃
 - (b) 3(a) or 3(b) are not met
 5. If baking is required, refer to IPC/JEDEC J-STD-033 for bake procedure
- Note : Level and body temperature defined by IPC/JEDEC J-STD-020

Aluminum Pack (310mmX370mm)



HIC(Humidity Indication Card)

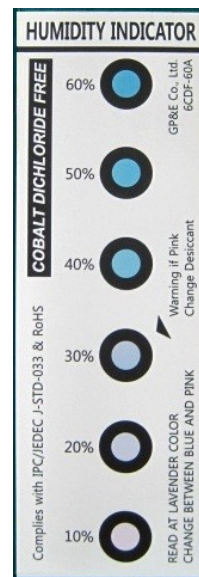

10 to 60% RH

11. PACKING

11-1. DIMENSIONS

- Carrier Tape

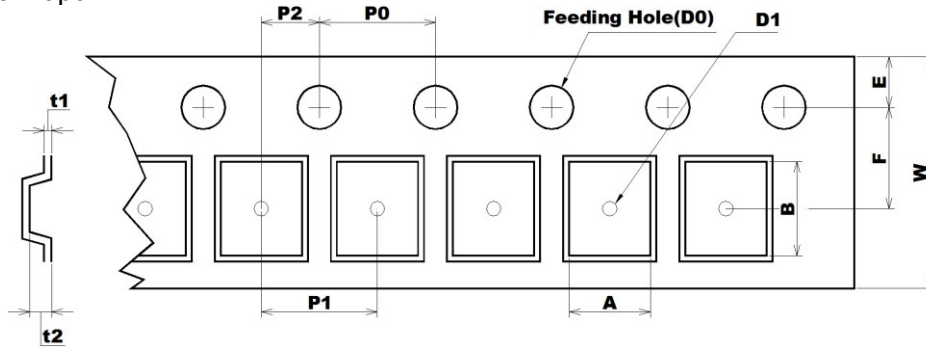

[Unit: mm]

A	B	D0	D1	E	F	P0	P1	P2	t1	t2	W
1.60	2.00	Ø1.55	Ø1.00	1.75	3.50	4.00	4.00	2.00	0.25	0.80	8.00
+0.05	+0.05	+0.05	MIN	+0.10	+0.05	+0.10	+0.10	+0.05	+0.05	+0.05	+0.10
-0.05	-0.05	-0.05		-0.10	-0.05	-0.10	-0.10	-0.05	-0.05	-0.05	-0.10

- Reel

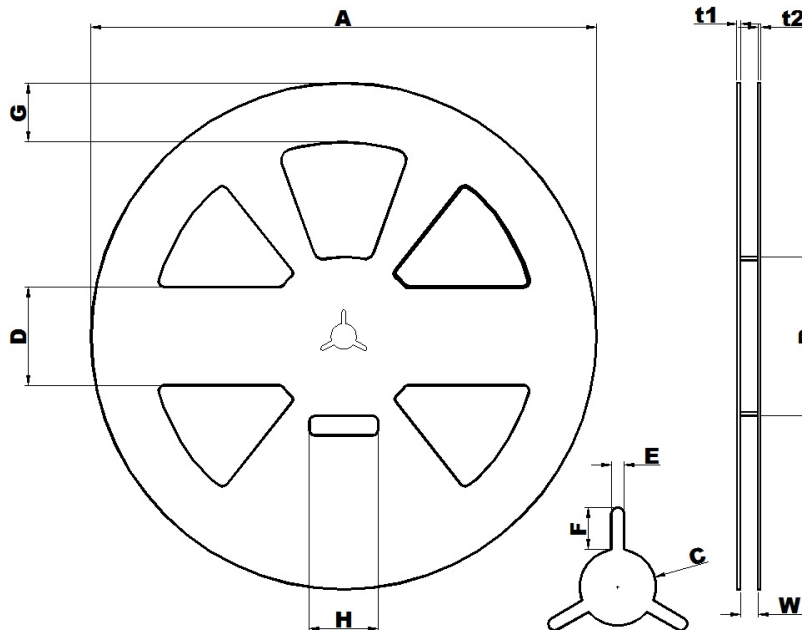

[Unit: mm]

A	B	C	D	E	F	G	H	t1	t2	W
Ø258.0	Ø81.0	Ø13.0	50.0	2.2	7.0	30.0	35.0	1.8	1.5	9.0
+1.0	+1.0	+0.5	+0.8	+0.3	+0.5	+0.8	+1.0	+0.5	+0.5	+1.0
-0.5	-1.0	-0.5	-0.8	-0.3	-0.5	-0.8	-1.0	-0.5	-0.5	-0.5

- The product shall be packed properly not to damaged during transportation and storage.

11-2. REELING QUANTITY
10 inch reel : 8,000 pcs/reel

11-3. TAPING STRUCTURE

11-3-1. The tape shall be wound around the reel in direction shown below.

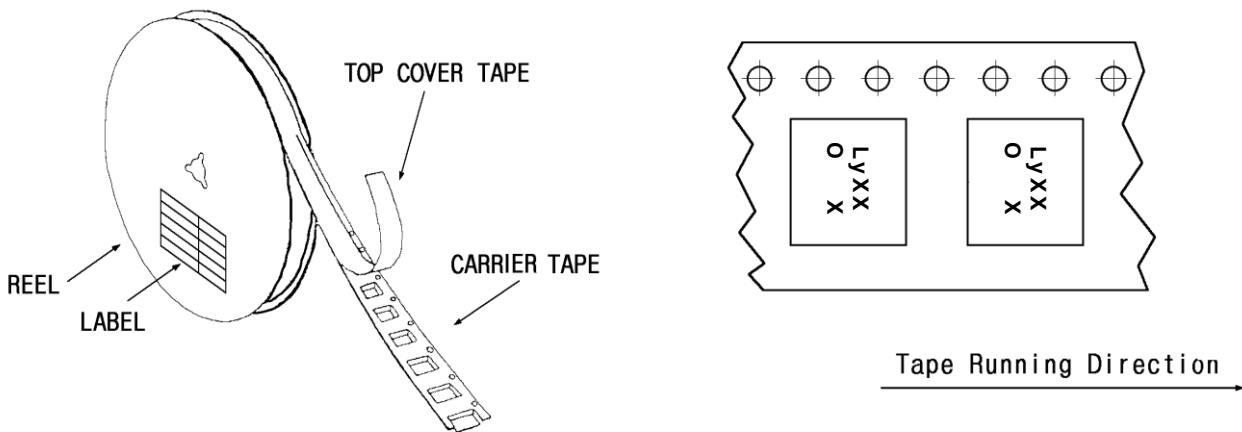

11-3-2. BARCODE LABEL

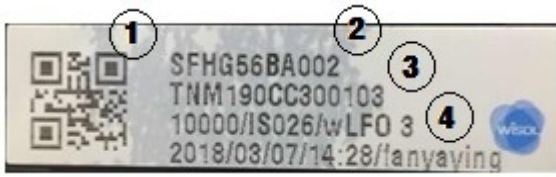

①	MODEL NAME BARCODE
②	Model Name
③	Reel number
④	Quantity / Marking

11-3-3. Leader part and vacant position specifications.

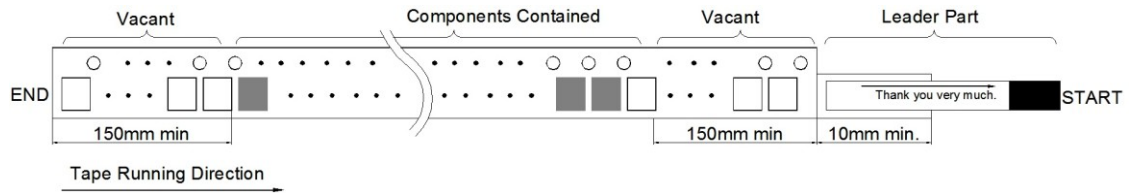

11-4. INNER BOX(Reel Packing) STRUCTURE

Material: Polycarbonate



Material : Polyethylene + Aluminium
Size : 310×370mm²

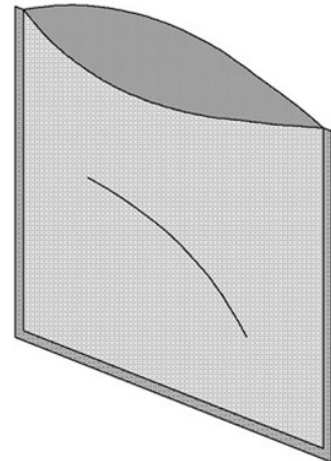

Material : Paper
Size: (D)290×(W)290×(H)42mm³

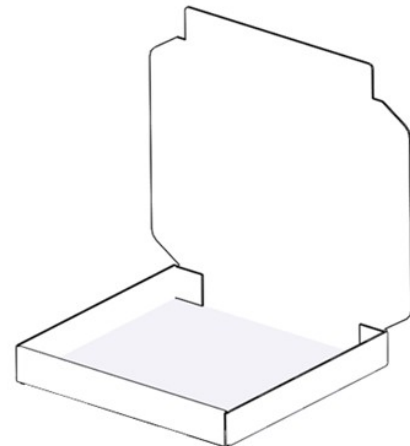

11-5. OUTER BOX STRUCTURE

Material : Paper

TYPE	SIZE(mm)			Inner Box #
	a	b	c	
A	300	270	300	6 boxes

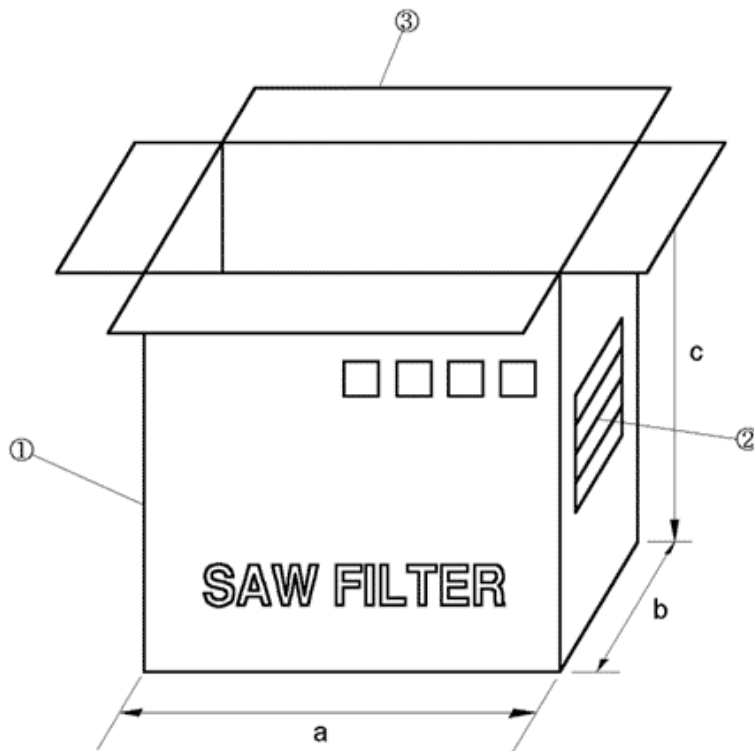

SIDE ①

SIDE ②

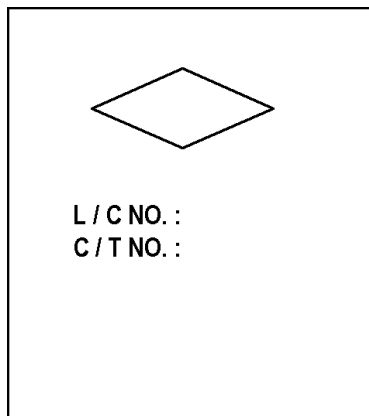

MODEL	
Q'TY	EA
USER	
DATE	. .

- SIDE is the same as front side.

12. TAPE SPECIFICATIONS

12-1. Tensile Strength of Carrier Tape: 4.4N/mm width

12-2. Top Cover Tape Adhesion (See the below figure)

- pull of angle: 0~15 degree
- speed: 300mm/min.
- force: 20~70g

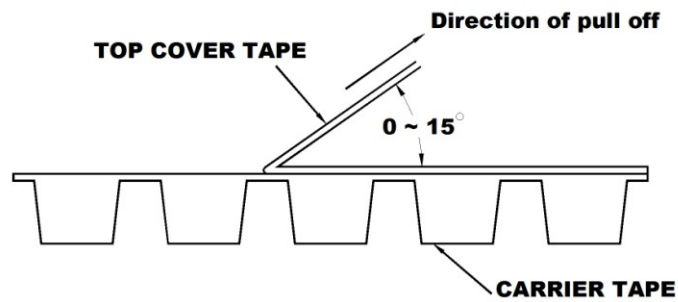

13. RoHS DATA

13-1. RAW MATERIAL(EPOXY)



Test Report

No. SHAEC1905695301

Date: 03 Apr 2019

Page 1 of 9

Nagase ChemteX Corporation

236, Tatsunocho-nakai, Tatsuno, Hyogo, 679-4124, Japan

The following sample(s) was/were submitted and identified on behalf of the clients as : A2038

SGS Job No. : SP19-009797 - SH
 Lot No. : M190313
 Date of Sample Received : 27 Mar 2019
 Testing Period : 27 Mar 2019 - 03 Apr 2019
 Test Requested : Selected test(s) as requested by client.
 Test Method : Please refer to next page(s).
 Test Results : Please refer to next page(s).
 Conclusion : Based on the performed tests on submitted sample(s), the results of Cadmium, Lead, Mercury, Hexavalent chromium, Polybrominated biphenyls (PBBs), Polybrominated diphenyl ethers (PBDEs) and Phthalates such as Bis(2-ethylhexyl) phthalate (DEHP), Butyl benzyl phthalate (BBP), Dibutyl phthalate (DBP) and Diisobutyl phthalate (DIBP) comply with the limits as set by RoHS Directive (EU) 2015/863 amending Annex II to Directive 2011/65/EU.

Signed for and on behalf of
 SGS-CSTC Standards Technical Services (Shanghai) Co., Ltd.

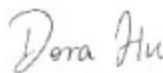

Dora Hu
 Approved Signatory



Unless otherwise agreed in writing, this document is issued by the Company subject to its General Conditions of Service granted herewith, applicable as requested or available at <http://www.sgs.com/en/terms-and-conditions.aspx> and, for electronic format documents, subject to Terms and Conditions for Electronic Documents at <http://www.sgs.com/en/terms-and-conditions/terms-e-document.aspx>. Attention is drawn to the limitation of liability, indemnification and jurisdiction issues defined therein. Any holder of this document is advised that information contained hereon reflects the Company's findings at the time of its intervention only and within the limits of Client's instructions, if any. The Company's sole responsibility is to its Client and this document does not exonerate parties to a transaction from exercising all their rights and obligations under the transaction documents. This document cannot be reproduced except in full, without prior written approval of the Company. Any unauthorized alteration, forgery or falsification of the content or appearance of this document is unlawful and offenders may be prosecuted to the fullest extent of the law. Unless otherwise stated the results shown in this test report refer only to the sample(s) tested.
 Attention: To check the authenticity of testing, inspection report & certificate, please contact us at telephone: (86) 755 8387 8843, or email: CN_Discover@sgs.com
 3 Building No.889 Yinan Road Xuhui District Shanghai China 200233 TEL (86-21) 61402553 FAX (86-21) 64953670 www.sgs.com.cn
 中国·上海·徐汇区宜山路889号3号楼 邮编: 200233 TEL (86-21) 61402594 FAX (86-21) 61159899 * sgs.china@sgs.com

Member of the SGS Group (SGS SA)



Test Report

No. SHAEC1905695301

Date: 03 Apr 2019

Page 2 of 9

Test Results :

Test Part Description :

Specimen No.	SGS Sample ID	Description
SN1	SHA19-056953.001	Black adhesive sheet

Remarks :

- (1) 1 mg/kg = 0.0001%
- (2) MDL = Method Detection Limit
- (3) ND = Not Detected (< MDL)
- (4) "-" = Not Regulated

RoHS Directive (EU) 2015/863 amending Annex II to Directive 2011/65/EU

Test Method : With reference to IEC 62321-4:2013+AMD1:2017, IEC62321-5:2013, IEC62321-7-2:2017, IEC 62321-6:2015 and IEC62321-8:2017, analyzed by ICP-OES, UV-Vis and GC-MS.

Test Item(s)	Limit	Unit	MDL	001
Lead (Pb)	1000	mg/kg	2	ND
Cadmium (Cd)	100	mg/kg	2	ND
Mercury (Hg)	1000	mg/kg	2	ND
Hexavalent Chromium (Cr(VI))	1000	mg/kg	8	ND
Sum of PBBs	1000	mg/kg	-	ND
Monobromobiphenyl	-	mg/kg	5	ND
Dibromobiphenyl	-	mg/kg	5	ND
Tribromobiphenyl	-	mg/kg	5	ND
Tetrabromobiphenyl	-	mg/kg	5	ND
Pentabromobiphenyl	-	mg/kg	5	ND
Hexabromobiphenyl	-	mg/kg	5	ND
Heptabromobiphenyl	-	mg/kg	5	ND
Octabromobiphenyl	-	mg/kg	5	ND
Nonabromobiphenyl	-	mg/kg	5	ND
Decabromobiphenyl	-	mg/kg	5	ND
Sum of PBDEs	1000	mg/kg	-	ND
Monobromodiphenyl ether	-	mg/kg	5	ND
Dibromodiphenyl ether	-	mg/kg	5	ND
Tribromodiphenyl ether	-	mg/kg	5	ND
Tetrabromodiphenyl ether	-	mg/kg	5	ND



Unless otherwise agreed in writing, this document is issued by the Company subject to its General Conditions of Service printed hereof, available on request or accessible at <http://www.sgs.com/en/Terms-and-Conditions.aspx> and, for electronic format documents, subject to Terms and Conditions for Electronic Documents at <http://www.sgs.com/en/Terms-and-Conditions/Terms-e-Documents.aspx>. Attention is drawn to the limitation of liability, indemnification and jurisdiction issues defined therein. Any holder of this document is advised that information contained hereon reflects the Company's findings at the time of its intervention only and within the limits of Client's instructions, if any. The Company's sole responsibility is to its Client and this document does not constitute parties to a transaction from exercising all their rights and obligations under the transaction documents. This document cannot be reproduced except in full, without prior written approval of the Company. Any unauthorized alteration, forgery or falsification of the content or appearance of this document is unlawful and offenders may be prosecuted to the fullest extent of the law. Unless otherwise stated the results shown in this test report refer only to the sample(s) tested.

Attention: To check the authenticity of testing/inspection report & certificate, please contact us at telephones: (86-755) 8107-1443, or email: CN-Check@sgs.com

3rd Building No. 808 Yishan Road Yuji District, Shanghai China 200233 TEL (86-21) 61402553 FAX (86-21) 61402579 www.sgs.com.cn
 中国·上海·徐汇区宜山路808号3号楼 邮编: 200233 TEL (86-21) 61402534 FAX (86-21) 61158893 sgs.china@sgs.com

Member of the SGS Group (SGS SA)

Test Report

No. SHAEC1905695301

Date: 03 Apr 2019

Page 3 of 9

Test Item(s)	Limit	Unit	MDL	001
Pentabromodiphenyl ether	-	mg/kg	5	ND
Hexabromodiphenyl ether	-	mg/kg	5	ND
Heptabromodiphenyl ether	-	mg/kg	5	ND
Octabromodiphenyl ether	-	mg/kg	5	ND
Nonabromodiphenyl ether	-	mg/kg	5	ND
Decabromodiphenyl ether	-	mg/kg	5	ND
Di-butyl Phthalate (DBP)	1000	mg/kg	50	ND
Benzyl Butyl Phthalate (BBP)	1000	mg/kg	50	ND
Di-2-Ethyl Hexyl Phthalate (DEHP)	1000	mg/kg	50	ND
Diisobutyl Phthalates (DIBP)	1000	mg/kg	50	ND

Notes :

- (1)The maximum permissible limit is quoted from RoHS Directive (EU) 2015/863. IEC 62321 series is equivalent to EN 62321 series
http://www.cenelec.eu/dyn/www/f?p=104:30:1742232870351101:::FSP_ORG_ID,FSP_LANG_ID:1258637,25
- (2)On 4 June 2015, Commission Directive (EU) 2015/863 was published in the Official Journal of the European Union (OJEU) to include the phthalates BBP, DBP, DEHP and DIBP into ANNEX II of the Rohs Recast Directive. The new law restricts each phthalate to no more than 0.1% in each homogeneous material of an electrical product.
- (3)The restriction of DEHP, BBP, DBP and DIBP shall apply to medical devices, including in vitro medical devices, and monitoring and control instruments, including industrial monitoring and control instruments, from 22 July 2021.
- (4)The restriction of DEHP, BBP, DBP and DIBP shall not apply to cables or spare parts for the repair, the reuse, the updating of functionalities or upgrading of capacity of EEE placed on the market before 22 July 2019, and of medical devices, including in vitro medical devices, and monitoring and control instruments, including industrial monitoring and control instruments, placed on the market before 22 July 2021.
- (5)The restriction of DEHP, BBP and DBP shall not apply to toys which are already subject to the restriction of DEHP, BBP and DBP through entry 51 of Annex XVII to Regulation (EC) No 1907/2006.

TVOC

Test Method : With reference to SGS in-house method (SHTC-CHEM-SOP-702),
 TVOC analysis was performed by TVOC portable detector.
 Benzene, Toluene, Formaldehyde and Phosphine analysis were performed by gas detecting tubes.



Unless otherwise agreed in writing, this document is issued by the Company subject to its General Conditions of Service printed overleaf, available on request or accessible at <http://www.sgs.com/en/Terms-and-Conditions.aspx> and, for electronic format documents, subject to Terms and Conditions for Electronic Documents at <http://www.sgs.com/en/Terms-and-Conditions/Terms-e-Documents.aspx>. Attention is drawn to the limitation of liability, indemnification and jurisdiction issues defined therein. Any holder of this document is advised that information contained herein reflects the Company's findings at the time of its intervention only and within the limits of Client's instructions, if any. The Company's sole responsibility is to its Client and this document does not exonerate parties to a transaction from exercising all their rights and obligations under the transaction documents. This document cannot be reproduced except in full, without prior written approval of the Company. Any unauthorized alteration, forgery or falsification of the content or appearance of this document is unlawful and offenders may be prosecuted to the fullest extent of the law. Unless otherwise stated the results shown in this test report refer only to the sample(s) tested.
 Attention: To check the authenticity of testing inspection report & certificates, please contact us at telephone: (86 755) 8197 1443, or email: CN_Doccheck@sgs.com
 3 Building No. 805 Yichen Road Xuhui District, Shanghai, China 200233 TEL: (86-21) 61402553 FAX: (86-21) 64485379 www.sgs.com.cn
 中国·上海·徐汇区宜山路805号3号楼 邮编: 200233 TEL: (86-21) 61402594 FAX: (86-21) 61156889 e: sgs.china@sgs.com

Member of the SGS Group (SGS SA)



Test Report

No. SHAEC1905695301

Date: 03 Apr 2019

Page 4 of 9

Test Item(s)	Unit	MDL	QOI
Sample amount	g	-	41.30
TVOC	ppmV	16	ND
Benzene	ppmV	0.8	ND
Toluene	ppmV	16	ND
Formaldehyde	ppmV	0.08	ND
Phosphine	ppmV	0.08	ND

Notes :

1. ppmV: Part per million by volume
2. Tedlar bag: 3L
3. Test condition: 40 °C , 30min

Halogen

Test Method : With reference to EN 14582: 2016 , analysis was performed by IC.

Test Item(s)	Unit	MDL	QOI
Fluorine (F)	mg/kg	50	ND
Chlorine (Cl)	mg/kg	50	ND
Bromine (Br)	mg/kg	50	ND
Iodine (I)	mg/kg	50	ND

Element(s)

Test Method : With reference to US EPA 3052:1996, analysis was performed by ICP-OES.

Test Item(s)	Unit	MDL	QOI
Antimony (Sb)	mg/kg	10	ND
Tin (Sn)	mg/kg	5	ND



Unless otherwise agreed in writing, this document is issued by the Company subject to its General Conditions of Service printed overleaf, available on request or accessible at <http://www.sgs.com/en/Terms-and-Conditions.aspx> and, for electronic format documents, subject to Terms and Conditions for Electronic Documents at <http://www.sgs.com/en/Terms-and-Conditions/Terms-a-Documents.aspx>. Attention is drawn to the limitation of liability, indemnification and jurisdiction clauses defined therein. Any holder of this document is advised that information contained herein reflects the Company's findings at the time of its intervention only and within the limits of Client's instructions, if any. The Company's sole responsibility is to its Client and this document does not constitute parties to a transaction from exercising all their rights and obligations under the transaction documents. This document cannot be reproduced, except in full, without prior written approval of the Company. Any unauthorized alteration, forgery or falsification of the content or appearance of this document is unlawful and offenders may be prosecuted to the fullest extent of the law. Unless otherwise stated the results shown in this test report refer only to the sample(s) tested.

Attention: To check the authenticity of testing/inspection report & certificate, please contact us at telephone: (86 755) 8387 1443, or email: CN_Dispatch@sgs.com

3rd Building No. 889 Yuhuan Road Xuhui District Shanghai China 200233 | F.ENE (86-21) 61402553 | F.ENE (86-21) 61402579 | www.sgs.com.cn
 中国·上海·徐汇区宜山路889号3号楼 邮编: 200235 | 电.ENE (86-21) 61402594 | 电.ENE (86-21) 61152859 | e.sgs.china@sgs.com

Member of the SGS Group (SGS SA)



Test Report

No. SHAEC1905695301

Date: 03 Apr 2019

Page 5 of 9

ATTACHMENTS

Pb/Cd/Hg/Cr⁶⁺/PBBs/PBDEs Testing Flow Chart

1) These samples were dissolved totally by pre-conditioning method according to below flow chart. (Cr⁶⁺ and PBBs/PBDEs test method excluded)

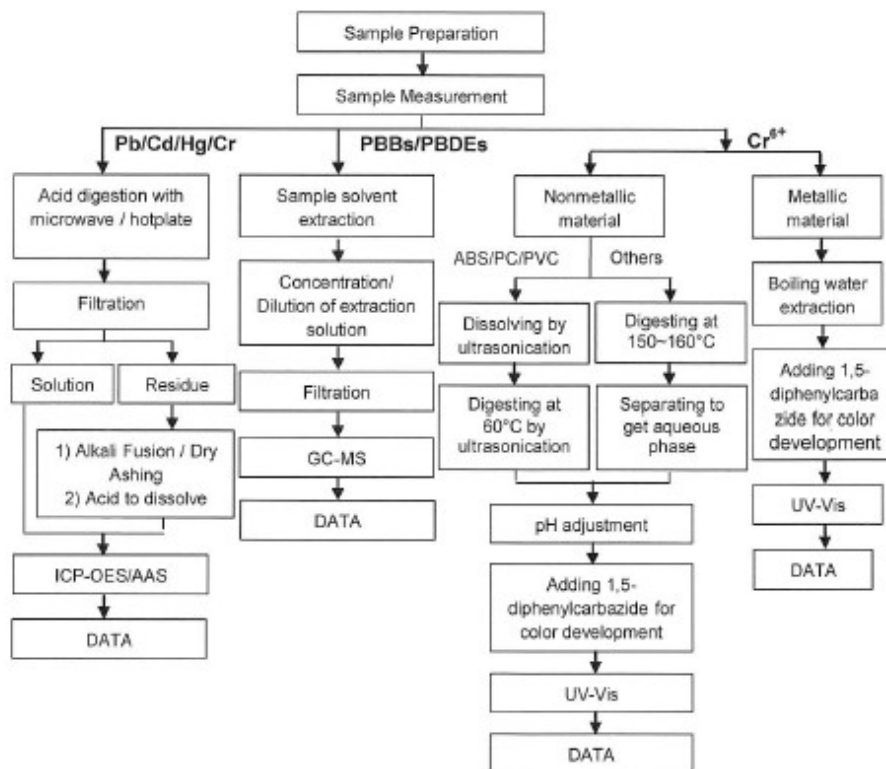

Unless otherwise agreed in writing, this document is issued by the Company subject to its General Conditions of Service printed on back, available on request or accessible at <http://www.sgs.com/Service-Terms-and-Conditions> and, for electronic format documents, subject to Terms and Conditions for Electronic Documents at <http://www.sgs.com/Service-Terms-and-Conditions/Terms-e-Documents>. Attention is drawn to the limitation of liability, indemnification and jurisdiction issues defined therein. Any holder of this document is advised that information contained herein reflects the Company's findings at the time of its inspection only and within the limits of Client's instructions, if any. The Company's sole responsibility is to its Client and this document does not concern parties to a transaction from exercising all their rights and obligations under the transaction documents. This document cannot be reproduced without the prior written approval of the Company. Any unauthorized alteration, forgery or falsification of the content or appearance of this document is unlawful and offenders may be prosecuted to the fullest extent of the law. Unless otherwise stated the results shown in this test report refer only to the sample(s) tested.

Attention: To check the authenticity of testing/inspection report & certificate, please contact us at telephone: (86) 750 8387 9443, or email: CN_Reccheck@sgs.com

3rd Building No.889 Yixian Road Xuhui District, Shanghai, China 200233 TEL: (86-21) 61402553 FAX: (86-21) 64063679 www.sgs.com.cn
 中国·上海·徐汇区宜山路889号3号楼 邮编: 200233 TEL: (86-21) 61402554 FAX: (86-21) 61150899 @ sgs.china@sgs.com

Member of the SGS Group (SGS SA)



Test Report

No. SHAEC1905695301

Date: 03 Apr 2019

Page 6 of 9

ATTACHMENTS

Phthalates Testing Flow Chart

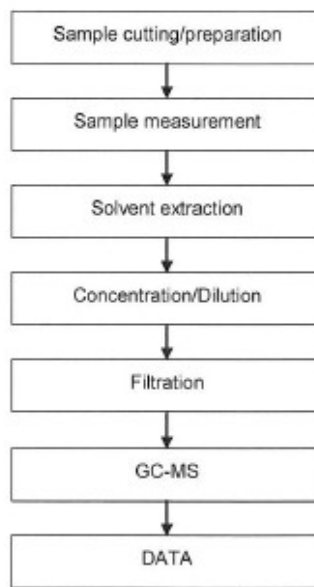

Unless otherwise agreed in writing, this document is issued by the Company subject to its General Conditions of Service printed overleaf, available on request or accessible at <http://www.sgs.com/Service-Conditions.aspx> and, for electronic format documents, subject to Terms and Conditions for Electronic Documents at <http://www.sgs.com/Service-Conditions.aspx>. Attention is drawn to the limitation of liability, indemnification and jurisdiction issues defined therein. Any holder of this document is advised that information contained herein reflects the Company's findings at the time of its issuance only, and within the limits of Client's instructions, if any. The Company's sole responsibility is to its Client and this document does not accredit parties to a transaction from exercising all their rights and obligations under the transaction documents. This document cannot be reproduced except in full, without prior written approval of the Company. Any unauthorized alteration, forgery or falsification of the content or appearance of this document is unlawful and offenders may be prosecuted to the fullest extent of the law. Unless otherwise stated the results shown in this test report refer only to the sample(s) tested.

Attention: To check the authenticity of testing inspection report & certificate, please contact us at telephone: 86-755-8167 1443, or email: CN_Deconack@sgs.com.
 3 Building No. 888 Yixian Road, Futu District, Shanghai, China 200233 TEL: (86-21) 61402553 FAX: (86-21) 64863679 www.sgs.com.cn
 中国·上海·徐汇区宜山路888号3号楼 邮编: 200233 TEL: (86-21) 6142294 FAX: (86-21) 61158890 e: sgs.china@sgs.com

Member of the SGS Group (SGS SA)



Test Report

No. SHAEC1905695301

Date: 03 Apr 2019

Page 7 of 9

ATTACHMENTS

Halogen Testing (oxygen bomb) Flow Chart

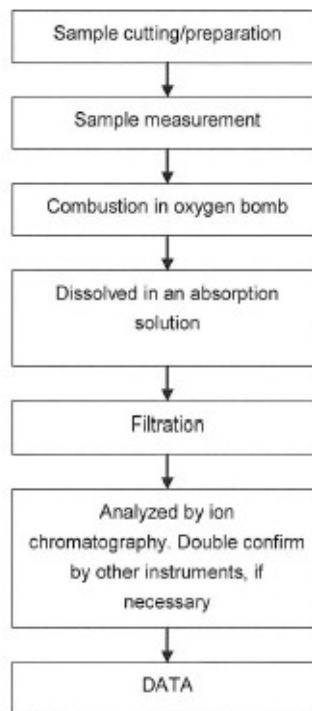

Unless otherwise agreed in writing, this document is issued by the Company subject to its General Conditions of Service printed overleaf, available on request or accessible at <http://www.sgs.com/terms-and-conditions.aspx> and, for electronic format documents, subject to Terms and Conditions for Electronic Documents at <http://www.sgs.com/terms-and-conditions/Terms-e-Documents.aspx>. Attention is drawn to the limitation of liability, indemnification and jurisdiction clauses defined therein. Any holder of this document is advised that information contained herein reflects the Company's findings at the time of its intervention only and within the limits of Client's instructions, if any. The Company's sole responsibility is to its Client and this document does not constitute parties to a transaction from exercising all their rights and obligations under the transaction documents. This document cannot be reproduced except in full, without prior written approval of the Company. Any unauthorized alteration, forgery or falsification of the content or appearance of this document is unlawful and offenders may be prosecuted to the fullest extent of the law. Unless otherwise stated the results shown in this report refer only to the samples tested.

Attention: To check the authenticity of testing inspection report & certificate, please contact us at telephone: (86-755)81671443, or email: SGSchina@sgs.com

3rd Building No. 888 Yishan Road, Pudong District, Shanghai, China 200233 TEL: (86-21) 61402553 FAX: (86-21) 64953679 www.sgs.com
 中国·上海·徐汇区宜山路888号3号楼 邮编: 200233 TEL: (86-21) 61402594 FAX: (86-21) 61156899 sgs.china@sgs.com

Member of the SGS Group (SGS SA)



Test Report

No. SHAEC1905695301

Date: 03 Apr 2019

Page 8 of 9

ATTACHMENTS

Elements Testing Flow Chart

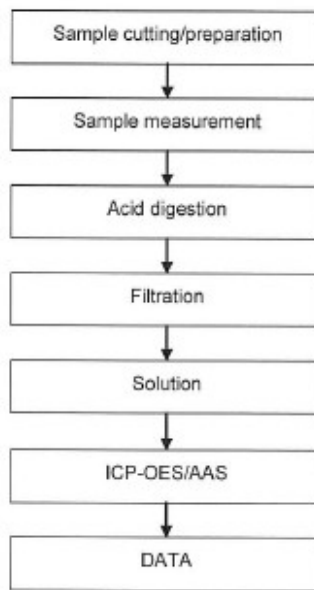

Unless otherwise agreed in writing, this document is issued by the Company subject to its General Conditions of Service printed overleaf, available on request or accessible at <http://www.sgs.com/en/Terms-and-Conditions.aspx> and, for electronic format documents, subject to Terms and Conditions for Electronic Documents at <http://www.sgs.com/en/Terms-and-Conditions/Terms-9-Documents.aspx>. Attention is drawn to the limitations of liability, indemnification and jurisdiction clauses defined therein. Any holder of this document is advised that information contained hereon reflects the Company's findings at the time of its intervention only and within the limits of Client's instructions, if any. The Company's sole responsibility is to its Client and this document does not exonerate parties to a transaction from exercising all their rights and obligations under the transaction documents. This document cannot be reproduced except in full, without prior written approval of the Company. Any unauthorized alteration, forgery or falsification of the content or appearance of this document is unlawful and offenders may be prosecuted to the fullest extent of the law. Unless otherwise stated the results shown in this test report refer only to the sample(s) tested.

Attention: To check the authenticity of testing inspection report & certificate, please contact us at telephone: (86) 795131071443, or email: CN_Docscheck@sgs.com

3 Building No. 589 Yishan Road, Anfu District, Shanghai, China 200233 TEL (86-21) 61402583 FAX (86-21) 61405379 www.sgs.com
 中国·上海·徐汇区宜山路689号3号楼 邮编: 200233 TEL (86-21) 61402584 FAX (86-21) 61159883 sgs.dcn@sgs.com

Member of the SGS Group (SGS SA)



Test Report

No. SHAEC1905695301

Date: 03 Apr 2019

Page 9 of 9

Sample photo:

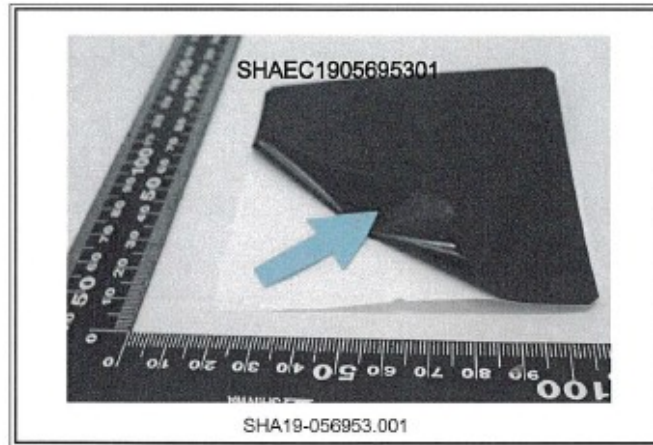

SGS authenticate the photo on original report only

*** End of Report ***



Unless otherwise agreed in writing, this document is issued by the Company subject to its General Conditions of Service printed overleaf, available on request or accessible at <http://www.sgs.com/en/Terms-and-Conditions.aspx> and, for electronic format documents, subject to Terms and Conditions for Electronic Documents at <http://www.sgs.com/en/Terms-and-Conditions/Terms-9-Electronic.aspx>. Attention is drawn to the limitation of liability, indemnification and jurisdiction issues defined therein. Any holder of this document is advised that information concerning herein reflects the Company's findings at the time of its intervention only and within the limits of Client's instructions, if any. The Company's sole responsibility is to its Client and this document does not exonerate parties to a transaction from exercising all their rights and obligations under the transaction documents. This document cannot be reproduced except in full, without prior written approval of the Company. Any unauthorized alteration, forgery or falsification of the content or appearance of this document is unlawful and offenders may be prosecuted to the fullest extent of the law. Unless otherwise stated the results shown in this test report refer only to the sample(s) tested.
Attention: To check the authenticity of testing, inspection report & certificate, please contact us at telephone: (86) 755(8367)4443, or email: CN_Sales@sgs.com

3rd Building No. 888 Yixian Road Xuhui District, Shanghai, China 200233 TEL (86-21) 61402553 FAX (86-21) 64826279 www.sgs.com.cn
中国·上海·徐汇区宜山路888号3号楼 邮编: 200233 TEL (86-21) 61402594 FAX (86-21) 61160889 e: sgs.china@sgs.com

Member of the SGS Group (SGS SA)

13-2. RAW MATERIAL(PACKAGE)



TEST REPORT

REPORT NO. JP/2019/111011 DATE: January 10,2020 PAGE: 1 OF 4

KYOCERA CORPORATION

1810 TAKI-CHO SATSUMASENDAI-SHI KAGOSHIMA JAPAN

THE FOLLOWING SAMPLE(S) WAS/WERE SUBMITTED AND IDENTIFIED BY/ON BEHALF OF THE CLIENT AS:
以下のサンプルは顧客により提供され、顧客に代わって確認を行いました:

SAMPLE DESCRIPTION : 1-01-4-20 KYOCERA: CERAMIC A440

CLIENT REF.NO :

SAMPLE RECEIVED : 2019/11/22

TESTING DATE : 2019/11/22 TO 2020/01/10

TEST REQUESTED : SELECTED TEST(S) AS REQUESTED BY CLIENT.
分析項目 : 分析項目は顧客の要求によります。

TEST METHOD(S) : WITH REFERENCE TO LATEST EDITION OF IEC62321 FOR RoHS 10 SUBSTANCES.
分析方法 : OTHER CHEMICALS WERE TESTED BY EACH APPROPRIATE METHOD.
RoHS 10物質の分析は最新版のIEC62321を参照しました。
それ以外の化学物質についてはそれぞれに最適な方法で分析を行いました。

TEST RESULT(S) : PLEASE REFER TO THE NEXT PAGE(S).
分析結果 : 以下のページをご参照願います。

丸山 文隆



Fumitaka Maruyama / Quality Officer
Central Chemical Laboratory
SGS Japan Inc.

This Test Report is issued by the Company under its General Conditions of Service printed overleaf or available on request and accessible at <http://www.sgs.com>. Attention is drawn to the limitation of liability, indemnification and jurisdiction issues defined therein. Unless otherwise stated the results shown in this Test Report refer only to the sample(s) tested. This Test Report cannot be reproduced except in full, without prior approval of the Company. Any unauthorized alteration, forgery or falsification of the content or appearance of this test report is unlawful and offenders may be prosecuted to the fullest extent of the law.

SGS Japan Inc. | YBP East Tower 12F, 134 Godo-cho Hodogaya-ku Yokohama 240-0005, Japan
t +81(0) 45 330 1100 f +81(0) 45 330 1108 URL: www.sgs.com

Member of the SGS Group (Société Générale de Surveillance)



TEST REPORT

REPORT NO. JP/2019/111011 DATE: January 10, 2020 PAGE: 2 OF 4

KYOCERA CORPORATION

1810 TAKI-CHO SATSUMASENDAI-SHI KAGOSHIMA JAPAN

TEST RESULT(S)

ITEM(S)	UNIT	RESULT	METHOD	INST./PLACE	MDL
CADMIUM(Cd)	mg/kg	N.D.	IEC62321-5: 2013	ICP-OES	2
LEAD(Pb)	mg/kg	N.D.	IEC62321-5: 2013	ICP-OES	2
MERCURY(Hg)	mg/kg	N.D.	IEC62321-4: 2013+AMD1: 2017	ICP-OES	2
CHROMIUM VI(Cr(VI))	mg/kg	N.D.	IEC62321-7-1: 2015	UV/VIS	2

NOTES: mg/kg = ppm, N.D. = Not Detected, INST. = INSTRUMENT, MDL = Method Detection Limit

REMARK: Test process and/or expression of test result have been specified by client.
The content of Cr(VI) has been calculated with regard to the sample weight as specified by client.

This Test Report is issued by the Company under its General Conditions of Service printed overleaf or available on request and accessible at <http://www.sgs.com>. Attention is drawn to the limitation of liability, indemnification and jurisdiction issues defined therein. Unless otherwise stated the results shown in this Test Report refer only to the sample(s) tested. This Test Report cannot be reproduced except, in full, without prior approval of the Company. Any unauthorized alteration, forgery or falsification of the content or appearance of this test report is unlawful and offenders may be prosecuted to the fullest extent of the law. A
この検査報告書は裏面に記載された、もしくは<http://www.sgs.com>で入手が可能なサービスに関する一般的条件に照して発行されます。さらには明記されている弊社の負うべき債務・補償の範囲及び責任免除の項目をご確認ください。特に弊に明記のない限り、この検査報告書に記載された結果は、検査した試料のみに限ります。この書類全体の複製・改変には、弊社からの事前の許可を得ること無く複製することを禁じます。この検査報告書を無断で複製、偽造、改ざんすることは違法であり、違反者に対しては法的手段を講ずることとなります。

SGS Japan Inc. | YBP East Tower 12F, 134 Godo-cho Hodogaya-ku Yokohama 240-0005, Japan
t +81(0) 45 330 1100 f +81(0) 45 330 1108 URL: www.sgs.com

Member of the SGS Group (Société Générale de Surveillance)



TEST REPORT

REPORT NO. JP/2019/111011 DATE: January 10, 2020 PAGE: 3 OF 4

KYOCERA CORPORATION

1810 TAKI-CHO SATSUMASENDAI-SHI KAGOSHIMA JAPAN

分析フローチャート MEASUREMENT FLOW CHART

1)酸分解前処理において試料を完全分解しています。

The sample was dissolved/ decomposed totally by acid pre-conditioning method according to below flow chart.

2)Cd, Pb, Hg, Cr, Cr(VI), PBB/PBDE

分析担当者 Name of the person in charge of measurement: 府川 亮平 Ryohei Fukawa

3)分析責任者 Name of the person responsible for measurement: 大谷 真由美 Mayumi Otani

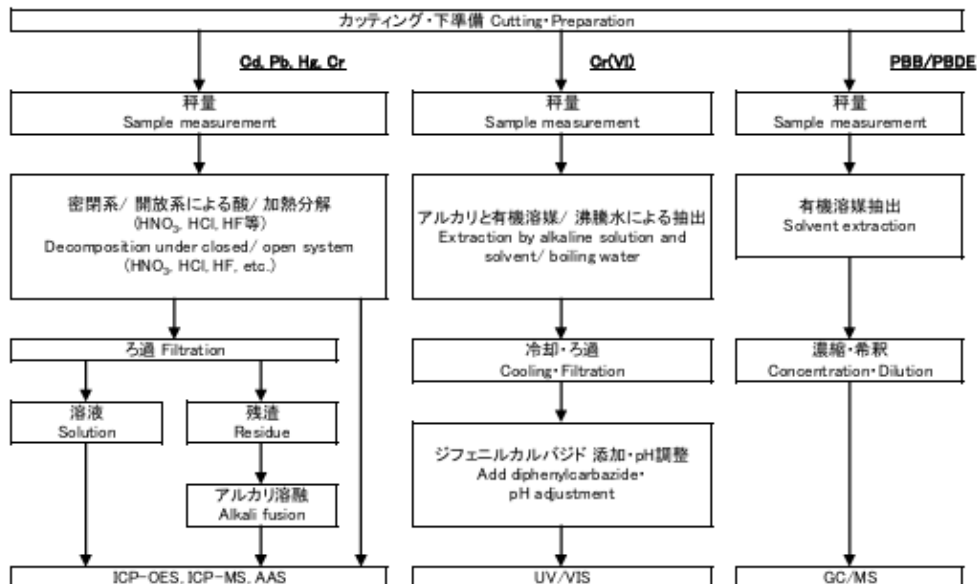

This Test Report is issued by the Company under its General Conditions of Service printed overleaf or available on request and accessible at <http://www.sgs.com>. Attention is drawn to the limitation of liability, indemnification and jurisdiction issues defined therein. Unless otherwise stated the results shown in this Test Report refer only to the sample(s) tested. This Test Report cannot be reproduced except, in full, without prior approval of the Company. Any unauthorized alteration, forgery or falsification of the content or appearance of this test report is unlawful and offenders may be prosecuted to the fullest extent of the law. A

この検査報告書は裏面に記載された、もしくは<http://www.sgs.com>で入手可能なサービスに関する一般的条件に照して発行されます。さららに明記されている弊社の負うべき債務・権限の範囲及び当該管轄の項目をご注意ください。他に弊に明記のない限り、この検査報告書に記載された結果は、検査した試料のみに限ります。この検査結果の複製・改竄は、弊社からの事前の許可を得ること無く複製することを禁じます。この複製報告書を無断で変更、偽造、改ざんすることは違法であり、違反者に対しては法的手段を講ずることとなります。

SGS Japan Inc. | YBP East Tower 12F, 134 Godo-cho Hodogaya-ku Yokohama 240-0005, Japan
t +81(0) 45 330 1100 f +81(0) 45 330 1108 URL: www.sgs.com

Member of the SGS Group (Société Générale de Surveillance)



TEST REPORT

REPORT NO. JP/2019/111011 DATE: January 10 2020 PAGE: 4 OF 4

KYOCERA CORPORATION

1810 TAKI-CHO SATSUMASENDAI-SHI KAGOSHIMA JAPAN

SAMPLE IMAGE



<END>

This Test Report is issued by the Company under its General Conditions of Service printed overleaf or available on request and accessible at <http://www.sgs.com>. Attention is drawn to the limitation of liability, indemnification and jurisdiction issues defined therein. Unless otherwise stated the results shown in this Test Report refer only to the sample(s) tested. This Test Report cannot be reproduced except, in full, without prior approval of the Company. Any unauthorized alteration, forgery or falsification of the content or appearance of this test report is unlawful and offenders may be prosecuted to the fullest extent of the law.

この検査報告書は裏面に記載された、もしくは<http://www.sgs.com>で入手可能なサービスに関する一般的条件に準じて発行されます。さらに明記されている弊社の責務・補償の範囲及び商品管轄の項目をご確認ください。特に弊に明記のない限り、この検査報告書に記載された結果は、検査した試料のみに属します。この書面全体の複製以外には、弊社からの事前の許可を得ること無く複製することを禁じます。この検査報告書を無断で変更、偽造、改ざんすることは違法であり、違反者に対しては法的手段を講ずることとなります。

SGS Japan Inc. YBP East Tower 12F, 134 Godo-cho Hodogaya-ku Yokohama 240-0005, Japan
t +81(0) 45 330 1100 f +81(0) 45 330 1108 URL: www.sgs.com

Member of the SGS Group (Société Générale de Surveillance)

TEST REPORT

REPORT NO. JP/2019/111053 DATE: January 10, 2020 PAGE: 1 OF 4

KYOCERA CORPORATION

1810 TAKI-CHO SATSUMASENDAI-SHI KAGOSHIMA JAPAN

THE FOLLOWING SAMPLE(S) WAS/WERE SUBMITTED AND IDENTIFIED BY/ON BEHALF OF THE CLIENT AS:
以下のサンプルは顧客により提供され、顧客に代わって確認を行いました:
SAMPLE DESCRIPTION : 4-01-4-20 KYOCERA: GOLD E-T

CLIENT REF.NO :

SAMPLE RECEIVED : 2019/11/22

TESTING DATE : 2019/11/22 TO 2020/01/10

TEST REQUESTED : SELECTED TEST(S) AS REQUESTED BY CLIENT.
分析項目 : 分析項目は顧客の要求によります。

TEST METHOD(S) : WITH REFERENCE TO LATEST EDITION OF IEC62321 FOR RoHS 10 SUBSTANCES.
分析方法 : OTHER CHEMICALS WERE TESTED BY EACH APPROPRIATE METHOD.
 RoHS 10物質の分析は最新版のIEC62321を参照しました。
 それ以外の化学物質についてはそれぞれに最適な方法で分析を行いました。

TEST RESULT(S) : PLEASE REFER TO THE NEXT PAGE(S).
分析結果 : 以下のページをご参照願います。

丸山 文隆

**Fumitaka Maruyama / Quality Officer
Central Chemical Laboratory
SGS Japan Inc.**

This Test Report is issued by the Company under its General Conditions of Service printed overleaf or available on request and accessible at <http://www.sgs.com>. Attention is drawn to the limitation of liability, indemnification and jurisdiction issues defined therein. Unless otherwise stated the results shown in this Test Report refer only to the sample(s) tested. A

This Test Report cannot be reproduced except in full, without prior approval of the Company. Any unauthorized alteration, forgery or falsification of the content or appearance of this test report is unlawful and offenders may be prosecuted to the fullest extent of the law.
 この検査報告書は裏面に記載された、もしくは<http://www.sgs.com>で入手可能なサービスに関する一般的条件に併せて発行されます。さららに明記されている弊社の商標・商標の範囲及び同社管轄の項目をご確認ください。特に弊に明記のない限り、この検査報告書に記載された結果は、検査した試料のみに限ります。この書面全体の複製以外には、弊社からの事前の許可を得ること無く複製することを禁じます。この検査報告書を無断で複製、偽造、改ざんすることは違法であり、違反者に対しては法的手段を講ずることとなります。

 SGS Japan Inc. | YBP East Tower 12F, 134 Godo-cho Hodogaya-ku Yokohama 240-0005, Japan
 t +81(0) 45 330 1100 f +81(0) 45 330 1108 URL: www.sgs.com

Member of the SGS Group (Société Générale de Surveillance)



TEST REPORT

REPORT NO. JP/2019/111053 DATE: January 10,2020 PAGE: 2 OF 4

KYOCERA CORPORATION

18 10 TAKI-CHO SATSUMASENDAI-SHI KAGOSHIMA JAPAN

TEST RESULT(S)

ITEM(S)	UNIT	RESULT	METHOD	INST./PLACE	MDL
CADMIUM(Cd)	mg/kg	N.D.	IEC62321-5: 2013	ICP-OES	2
LEAD(Pb)	mg/kg	N.D.	IEC62321-5: 2013	ICP-OES	2
MERCURY(Hg)	mg/kg	N.D.	IEC62321-4: 2013+AMD1: 2017	ICP-OES	2
CHROMIUM VI(Cr(VI))	μg/cm ²	N.D.	IEC62321-7-1: 2015	UV/VIS	0.01

NOTES: mg/kg = ppm, N.D. = Not Detected, INST. = INSTRUMENT, MDL = Method Detection Limit

REMARK: Cr(VI) has been tested with regard to the surface area of 12cm².
Reference: The MDL of Cr(VI) can be converted into 2 (ppm) with regard to the sample weight.

This Test Report is issued by the Company under its General Conditions of Service printed overleaf or available on request and accessible at <http://www.sgs.com>. Attention is drawn to the limitation of liability, indemnification and jurisdiction issues defined therein. Unless otherwise stated the results shown in this Test Report refer only to the sample(s) tested. This Test Report cannot be reproduced except in full, without prior approval of the Company. Any unauthorized alteration, forgery or falsification of the content or appearance of this test report is unlawful and offenders may be prosecuted to the fullest extent of the law. A
この検査報告書は裏面に記載された、もしくは<http://www.sgs.com>で入手可能なサービスに関する一般的条件に照して発行されます。さららに用記されている弊社の負うべき債務・補償の範囲及び品質管理の項目をご確認ください。特に弊に明記のない限り、この検査報告書に記載された結果は、検査した試料のみに属します。この書類全体の複製以外には、弊社からの事前の許可を得ること無く複製することを禁じます。この検査報告書を無断で複製、偽造、改ざんすることは違法であり、違反者に対しては法的手段を講ずることとなります。

SGS Japan Inc. | YBP East Tower 12F, 134 Godo-cho Hodogaya-ku Yokohama 240-0005, Japan
t +81(0) 45 330 1100 f +81(0) 45 330 1108 URL: www.sgsgroup.jp

Member of the SGS Group (Société Générale de Surveillance)



TEST REPORT

REPORT NO. JP/2019/111053 DATE: January 10, 2020 PAGE: 3 OF 4

KYOCERA CORPORATION

1810 TAKI-CHO SATSUMASENDAI-SHI KAGOSHIMA JAPAN

分析フローチャート MEASUREMENT FLOW CHART

1)酸分解前処理において試料を完全分解しています。

The sample was dissolved/ decomposed totally by acid pre-conditioning method according to below flow chart.

2)Cd, Pb, Hg, Cr, Cr(VI), PBB/PBDE

分析担当者 Name of the person in charge of measurement: 府川 亮平 Ryohei Fukawa

3)分析責任者 Name of the person responsible for measurement: 大谷 真由美 Mayumi Otani

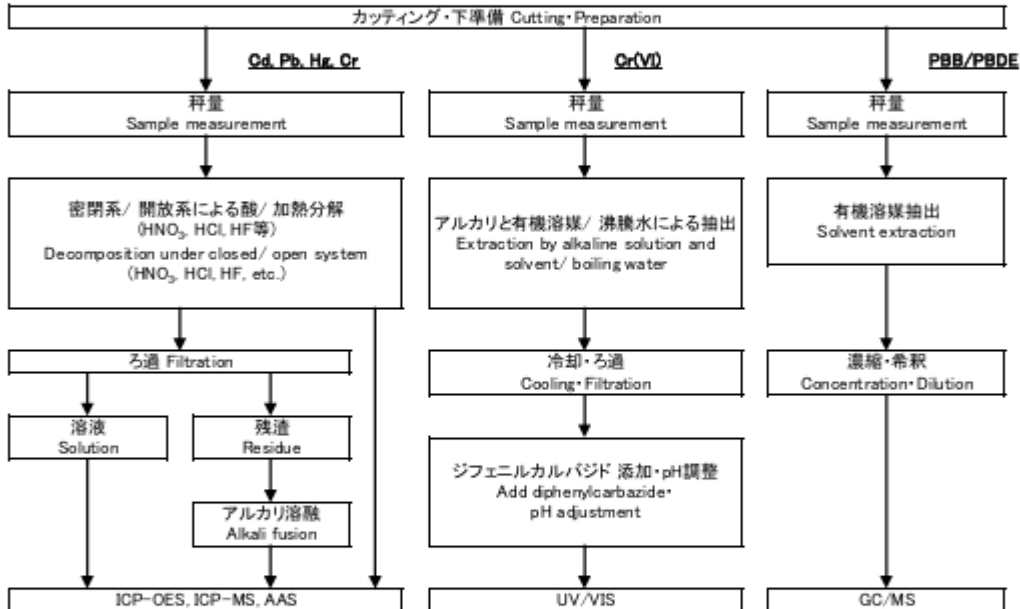

This Test Report is issued by the Company under its General Conditions of Service printed overleaf or available on request and accessible at <http://www.sgs.com>. Attention is drawn to the limitation of liability, indemnification and jurisdiction issues defined therein. Unless otherwise stated the results shown in this Test Report refer only to the sample(s) tested. This Test Report cannot be reproduced except, in full, without prior approval of the Company. Any unauthorized alteration, forgery or falsification of the content or appearance of this test report is unlawful and offenders may be prosecuted to the fullest extent of the law. A
この検査報告書は裏面に記載された、もしくは<http://www.sgs.com>で入手可能なサービスに関する一般的条件に照して発行されます。さらには明記されている弊社の負うべき債務・補償の範囲及び責任の項目をご注意ください。他に弊に類似のなごり、この検査報告書に記載された結果は、検査した試料のみに限ります。この検査報告書の複製以外には、弊社からの事前の許可を得ることなく複製することを禁じます。この検査報告書を無断で複製、偽造、改ざんすることは違法であり、違反者に対しては法的手段を講ずることとなります。

SGS Japan Inc. YBP East Tower 12F, 134 Godo-cho Hodogaya-ku Yokohama 240-0005, Japan
t +81(0) 45 330 1100 f +81(0) 45 330 1108 URL: www.sgs.com

Member of the SGS Group (Société Générale de Surveillance)



TEST REPORT

REPORT NO. JP/2019/111053 DATE: January 10 2020 PAGE: 4 OF 4

KYOCERA CORPORATION

1810 TAKI-CHO SATSUMASENDAI-SHI KAGOSHIMA JAPAN

SAMPLE IMAGE



<END>

This Test Report is issued by the Company under its General Conditions of Service printed overleaf or available on request and accessible at <http://www.sgs.com>. Attention is drawn to the limitation of liability, indemnification and jurisdiction issues defined therein. Unless otherwise stated the results shown in this Test Report refer only to the sample(s) tested. This Test Report cannot be reproduced except, in full, without prior approval of the Company. Any unauthorized alteration, forgery or falsification of the content or appearance of this test report is unlawful and offenders may be prosecuted to the fullest extent of the law.

A

この検査報告書は表紙に記載された、もしくは<http://www.sgs.com>で入手可能なサービスに関する一般的条件に則して発行されます。さららに明記されている弊社の負うべき債務・補償の範囲及び消滅管轄の項目をご確認ください。他に弊に明記のない限り、この検査報告書に記載された結果は、検査した試料のみに属します。この書面全体の複製以外には、弊社からの事前の許可を得ること無く複製することを禁じます。この検査報告書を無断で変更、偽造、改ざんすることは違法であり、違反者に対しては法的手段を講ずることとなります。

SGS Japan Inc. YBP East Tower 12F, 134 Godo-cho Hodogaya-ku Yokohama 240-0005, Japan
t +81(0) 45 330 1100 f +81(0) 45 330 1106 URL: www.sgs.com

Member of the SGS Group (Société Générale de Surveillance)

TEST REPORT

REPORT NO. JP/2019/111035

DATE: January 10, 2020

PAGE: 1 OF 4

KYOCERA CORPORATION

1810 TAKI-CHO SATSUMASENDAI-SHI KAGOSHIMA JAPAN

THE FOLLOWING SAMPLE(S) WAS/WERE SUBMITTED AND IDENTIFIED BY/ON BEHALF OF THE CLIENT AS:
 以下のサンプルは顧客により提供され、顧客に代わって確認を行いました:

SAMPLE DESCRIPTION : 2-01-4-20 KYOCERA: METALLIZATION for ALUMINA

CLIENT REF.NO :

SAMPLE RECEIVED : 2019/11/22

TESTING DATE : 2019/11/22 TO 2020/01/10

TEST REQUESTED : SELECTED TEST(S) AS REQUESTED BY CLIENT.
分析項目 : 分析項目は顧客の要求によります。

TEST METHOD(S) : WITH REFERENCE TO LATEST EDITION OF IEC62321 FOR RoHS 10 SUBSTANCES.
分析方法 : OTHER CHEMICALS WERE TESTED BY EACH APPROPRIATE METHOD.
 RoHS 10物質の分析は最新版のIEC62321を参照しました。
 それ以外の化学物質についてはそれぞれに最適な方法で分析を行いました。

TEST RESULT(S) : PLEASE REFER TO THE NEXT PAGE(S).
分析結果 : 以下のページをご参照願います。

丸山 文隆

Fumitaka Maruyama / Quality Officer
Central Chemical Laboratory
SGS Japan Inc.

This Test Report is issued by the Company under its General Conditions of Service printed overleaf or available on request and accessible at <http://www.sgs.com>. Attention is drawn to the limitation of liability, indemnification and jurisdiction issues defined therein. Unless otherwise stated the results shown in this Test Report refer only to the sample(s) tested. This Test Report cannot be reproduced except, in full, without prior approval of the Company. Any unauthorized alteration, forgery or falsification of the content or appearance of this test report is unlawful and offenders may be prosecuted to the fullest extent of the law.

この検査報告書は裏面に記載された、もしくは<http://www.sgs.com>で入手可能なサービスマニュアルに関する一般的条件に因りて発行されます。さらにも記載されている弊社の負うべき債務・補償の範囲及び責任の項目をご注意ください。特に明記のない限り、この検査報告書に記載された結果は、検査した試料のみに属します。この書類全体の複製以外には、弊社からの事前の許可を得ること無く複製することを禁じます。この検査報告書を無断で変更、偽造、改ざんすることは違法であり、違反者に対しては法的手段を講ずることとなります。

SGS Japan Inc. | YBP East Tower 12F, 134 Godo-cho Hodogaya-ku Yokohama 240-0005, Japan
 t +81(0) 45 330 1100 f +81(0) 45 330 1108 URL: www.sgsgroup.jp

Member of the SGS Group (Société Générale de Surveillance)



TEST REPORT

REPORT NO. JP/2019/111035 DATE: January 10,2020 PAGE: 2 OF 4

KYOCERA CORPORATION

18 10 TAKI-CHO SATSUMASENDAI-SHI KAGOSHIMA JAPAN

TEST RESULT(S)

ITEM(S)	UNIT	RESULT	METHOD	INST./PLACE	MDL
CADMIUM(Cd)	mg/kg	N.D.	IEC62321-5: 2013	ICP-OES	2
LEAD(Pb)	mg/kg	N.D.	IEC62321-5: 2013	ICP-OES	2
MERCURY(Hg)	mg/kg	N.D.	IEC62321-4: 2013+AMD1: 2017	ICP-OES	2
CHROMIUM VI(Cr(VI))	mg/kg	N.D.	IEC62321-7-1: 2015	UV/VIS	2

NOTES: mg/kg = ppm, N.D. = Not Detected, INST. = INSTRUMENT, MDL = Method Detection Limit

REMARK: Test process and/or expression of test result have been specified by client.
The content of Cr(VI) has been calculated with regard to the sample weight as specified by client.

This Test Report is issued by the Company under its General Conditions of Service printed overleaf or available on request and accessible at <http://www.sgs.com>. Attention is drawn to the limitation of liability, indemnification and jurisdiction issues defined therein. Unless otherwise stated the results shown in this Test Report refer only to the sample(s) tested. This Test Report cannot be reproduced except, in full, without prior approval of the Company. Any unauthorized alteration, forgery or falsification of the content or appearance of this test report is unlawful and offenders may be prosecuted to the fullest extent of the law. A
この検査報告書は裏面に記載された、もしくは<http://www.sgs.com>で入手可能なサービスに関する一般的条件に照して発行されます。さららに明記されている弊社の負うべき債務・補償の範囲及び責任管轄の項目をご注意ください。特に明記のない限り、この検査報告書に記載された結果は、検査した試料のみに限ります。この書類全体の複製以外には、弊社からの事前の許可を得ること無く複製することを禁じます。この検査報告書が無断で変更、偽造、改ざんすることは違法であり、違反者に対しては法的手段を講ずることとなります。

SGS Japan Inc. | YBP East Tower 12F, 134 Godo-cho Hodogaya-ku Yokohama 240-0005, Japan
t +81(0) 45 330 1100 f +81(0) 45 330 1108 URL: www.sgsgroup.jp

Member of the SGS Group (Société Générale de Surveillance)



TEST REPORT

REPORT NO. JP/2019/111035

DATE: January 10, 2020

PAGE: 3 OF 4

KYOCERA CORPORATION

1810 TAKI-CHO SATSUMASENDAI-SHI KAGOSHIMA JAPAN

分析フローチャート MEASUREMENT FLOW CHART

1)酸分解前処理において試料を完全分解しています。

The sample was dissolved/ decomposed totally by acid pre-conditioning method according to below flow chart.

2)Cd, Pb, Hg, Cr, Cr(VI), PBB/PBDE

分析担当者 Name of the person in charge of measurement: 府川 亮平 Ryohei Fukawa

3)分析責任者 Name of the person responsible for measurement: 大谷 真由美 Mayumi Otani

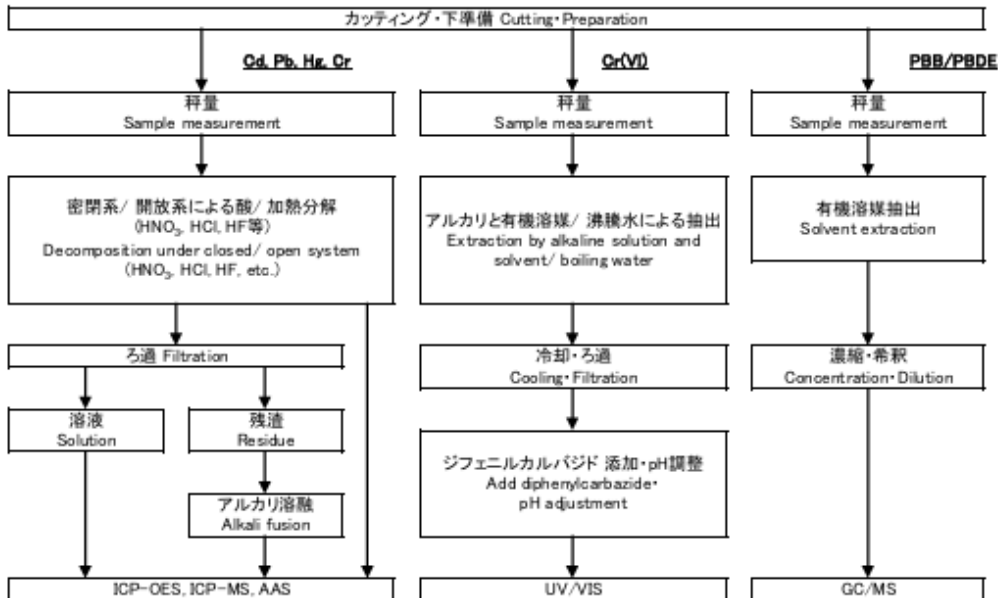

This Test Report is issued by the Company under its General Conditions of Service printed overleaf or available on request and accessible at <http://www.sgs.com>. Attention is drawn to the limitation of liability, indemnification and jurisdiction issues defined therein. Unless otherwise stated the results shown in this Test Report refer only to the sample(s) tested. This Test Report cannot be reproduced except in full, without prior approval of the Company. Any unauthorized alteration, forgery or falsification of the content or appearance of this test report is unlawful and offenders may be prosecuted to the fullest extent of the law.

この検査報告書は裏面に記載された、もしくは<http://www.sgs.com>で入手可能なサービスに関する一般的条件に準じて発行されます。さらに明記されている弊社の負うべき債務・補償の範囲及び司法管轄の項目をご確認ください。特に特に明記のない限り、この検査報告書に記載された結果は、検査した試料のみに限ります。この書類全体の複製以外には、弊社からの事前の許可を得ること無く複製することを禁じます。この検査報告書が無断で変更、偽造、改ざんすることは違法であり、違反者に対しては法的手段を講ずることとなります。

SGS Japan Inc. YBP East Tower 12F, 134 Godo-cho Hodogaya-ku Yokohama 240-0005, Japan
t +81(0) 45 330 1100 f +81(0) 45 330 1108 URL: www.sgs.com

Member of the SGS Group (Société Générale de Surveillance)



TEST REPORT

REPORT NO. JP/2019/111035

DATE: January 10, 2020

PAGE: 4 OF 4

KYOCERA CORPORATION

1810 TAKI-CHO SATSUMASENDAI-SHI KAGOSHIMA JAPAN

SAMPLE IMAGE



<END>

This Test Report is issued by the Company under its General Conditions of Service printed overleaf or available on request and accessible at <http://www.sgs.com>. Attention is drawn to the limitation of liability, indemnification and jurisdiction issues defined therein. Unless otherwise stated the results shown in this Test Report refer only to the sample(s) tested. This Test Report cannot be reproduced except, in full, without prior approval of the Company. Any unauthorized alteration, forgery or falsification of the content or appearance of this test report is unlawful and offenders may be prosecuted to the fullest extent of the law. A

この検査報告書は表紙に記載された、もしくは<http://www.sgs.com>で入手可能なサービスに関する一般的条件に照して発行されます。さらには明記されている弊社の責務・権限の範囲及び出払書類の項目をご注意ください。特に弊に明記のない限り、この検査報告書に記載された結果は、検査した試料のみに限ります。この書類全体の複製は弊社は、弊社からの事前の許可を得ること無く複製することを禁じます。この複製報告書が無断で変更、偽造、改ざんすることは違法であり、違反者に対しては法的手段を講ずることとなります。

SGS Japan Inc. | YBP East Tower 12F, 134 Godo-cho Hodogaya-ku Yokohama 240-0005, Japan
t +81(0) 45 330 1100 f +81(0) 45 330 1108 URL: www.ssgroup.jp

Member of the SGS Group (Société Générale de Surveillance)

TEST REPORT

REPORT NO. JP/2019/111047

DATE: January 10, 2020

PAGE: 1 OF 4

KYOCERA CORPORATION

1-1 KOKUBUYAMASHITA-CHO KIRISHIMA-SHI KAGOSHIMA JAPAN

THE FOLLOWING SAMPLE(S) WAS/WERE SUBMITTED AND IDENTIFIED BY/ON BEHALF OF THE CLIENT AS:
以下のサンプルは顧客により提供され、顧客に代わって確認を行いました:
SAMPLE DESCRIPTION : 3-01-4-20 KYOCERA: NICKEL E-S

CLIENT REF.NO :
SAMPLE RECEIVED : 2019/11/22

TESTING DATE : 2019/11/22 TO 2020/01/10

TEST REQUESTED : SELECTED TEST(S) AS REQUESTED BY CLIENT.
分析項目 : 分析項目は顧客の要求によります。

TEST METHOD(S) : WITH REFERENCE TO LATEST EDITION OF IEC62321 FOR RoHS 10 SUBSTANCES.
分析方法 : OTHER CHEMICALS WERE TESTED BY EACH APPROPRIATE METHOD.
 RoHS 10物質の分析は最新版のIEC62321を参照しました。
 それ以外の化学物質についてはそれぞれに最適な方法で分析を行いました。

TEST RESULT(S) : PLEASE REFER TO THE NEXT PAGE(S).
分析結果 : 以下のページをご参照願います。

丸山 文隆

**Fumitaka Maruyama / Quality Officer
Central Chemical Laboratory
SGS Japan Inc.**

This Test Report is issued by the Company under its General Conditions of Service printed overleaf or available on request and accessible at <http://www.sgs.com>. Attention is drawn to the limitation of liability, indemnification and jurisdiction issues defined therein. Unless otherwise stated the results shown in this Test Report refer only to the sample(s) tested. This Test Report cannot be reproduced except, in full, without prior approval of the Company. Any unauthorized alteration, forgery or falsification of the content or appearance of this test report is unlawful and offenders may be prosecuted to the fullest extent of the law.

この検査報告書は裏面に記載された、もしくは<http://www.sgs.com>で入手可能なサービスに関する一般的条件に照して発行されます。さらには記載されている弊社の負うべき債務・補償の範囲及び司法管轄の項目をご確認ください。他に特に明記のない限り、この検査報告書に記載された結果は、検査した試料のみに属します。この書類全体の複製以外には、弊社からの事前の許可を得ること無く複製することを禁じます。この検査報告書を無断で変更、偽造、改ざんすることは違法であり、違反者に対しては法的手段を講ずることとなります。

SGS Japan Inc. | YBP East Tower 12F, 134 Godo-cho Hodogaya-ku Yokohama 240-0005, Japan
 t +81(0) 45 330 1100 f +81(0) 45 330 1108 URL: www.sgs.com

Member of the SGS Group (Société Générale de Surveillance)



TEST REPORT

REPORT NO. JP/2019/111047 DATE: January 10, 2020 PAGE: 2 OF 4

KYOCERA CORPORATION

1-1 KOKUBUYAMASHITA-CHO KIRISHIMA-SHI KAGOSHIMA JAPAN

TEST RESULT(S)

ITEM(S)	UNIT	RESULT	METHOD	INST./PLACE	MDL
CADMIUM(Cd)	mg/kg	N.D.	Acid dissolution	ICP-OES	5
LEAD(Pb)	mg/kg	35	Acid dissolution	ICP-MS	5
MERCURY(Hg)	mg/kg	N.D.	Acid dissolution	ICP-OES	5
CHROMIUM VI(Cr(VI))	μg/cm ²	N.D.	IEC62321-7-1: 2015	UV/VIS	0.01

NOTES: mg/kg = ppm, N.D. = Not Detected, INST. = INSTRUMENT, MDL = Method Detection Limit

REMARK: The content of Cd, Pb and Hg have been calculated with regard to Ni, Co and Pb result.
Cr(VI) has been tested with regard to the surface area of 40cm².
Reference: The MDL of Cr(VI) can be converted into 10 (ppm).

This Test Report is issued by the Company under its General Conditions of Service printed overleaf or available on request and accessible at <http://www.sgs.com>. Attention is drawn to the limitation of liability, indemnification and jurisdiction issues defined therein. Unless otherwise stated the results shown in this Test Report refer only to the sample(s) tested. This Test Report cannot be reproduced except, in full, without prior approval of the Company. Any unauthorized alteration, forgery or falsification of the content or appearance of this test report is unlawful and offenders may be prosecuted to the fullest extent of the law. **A**

この検査報告書は裏面に記載された、もしくは<http://www.sgs.com>で入手が可能なサービスに関する一般的条件に準じて発行されます。それらに記載されている弊社の負うべき債務・補償の範囲及び責任免除の項目をご注意ください。特に弊に記載のない限り、この検査報告書に記載された結果は、検査した試料のみに限ります。この書類全体の複製以外には、弊社からの事前の許可を得ること無く複製することを禁じます。この検査報告書を無断で複製、偽造、改ざんすることは違法であり、違反者に対しては法的手段を講ずることとなります。

SGS Japan Inc. | YBP East Tower 12F, 134 Godo-cho Hodogaya-ku Yokohama 240-0005, Japan
t +81(0) 45 330 1100 f +81(0) 45 330 1108 URL: www.sgs.com

Member of the SGS Group (Société Générale de Surveillance)



TEST REPORT

REPORT NO. JP/2019/111047

DATE: January 10, 2020

PAGE: 3 OF 4

KYOCERA CORPORATION

1-1 KOKUBUYAMASHITA-CHO KIRISHIMA-SHI KAGOSHIMA JAPAN

分析フローチャート MEASUREMENT FLOW CHART

- 1) 分析担当者 Name of the person in charge of measurement: 府川 亮平 Ryohei Fukawa
- 2) 分析責任者 Name of the person responsible for measurement: 大谷 真由美 Mayumi Otani

メッキ皮膜中の重金属分析
Analysis of Heavy metal
for Plating layer

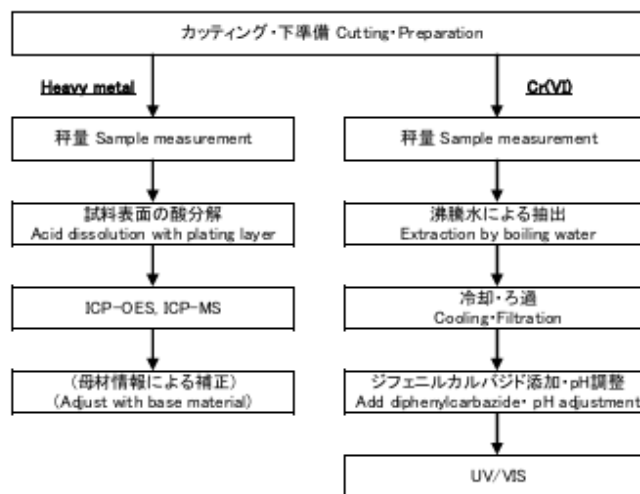

This Test Report is issued by the Company under its General Conditions of Service printed overleaf or available on request and accessible at <http://www.sgs.com>. Attention is drawn to the limitation of liability, indemnification and jurisdiction issues defined therein. Unless otherwise stated the results shown in this Test Report refer only to the sample(s) tested. This Test Report cannot be reproduced except, in full, without prior approval of the Company. Any unauthorized alteration, forgery or falsification of the content or appearance of this Test Report is unlawful and offenders may be prosecuted to the fullest extent of the law.

この検査報告書は裏面に記載された、もしくは<http://www.sgs.com>で入手可能なサービスに関する一般的条件に因りて発行されます。それらに記載されている弊社の負うべき債務・補償の範囲及び責任の項目をご確認ください。特に明記のない限り、この検査報告書に記載された結果は、検査した試料のみに属します。この書面全体の複製以外には、弊社からの事前の許可を得ること無く複製することを禁じます。この検査報告書が無断で変更、偽造、改ざんすることは違法であり、違反者に対しては法的手段を講ずることとなります。

SGS Japan Inc. YBP East Tower 12F, 134 Godo-cho Hodogaya-ku Yokohama 240-0005, Japan
t +81(0) 45 330 1100 f +81(0) 45 330 1108 URL: www.sgs.com

Member of the SGS Group (Société Générale de Surveillance)



TEST REPORT

REPORT NO. JP/2019/111047

DATE: January 10, 2020

PAGE: 4 OF 4

KYOCERA CORPORATION

1-1 KOKUBUYAMASHITA-CHO KIRISHIMA-SHI KAGOSHIMA JAPAN

SAMPLE IMAGE

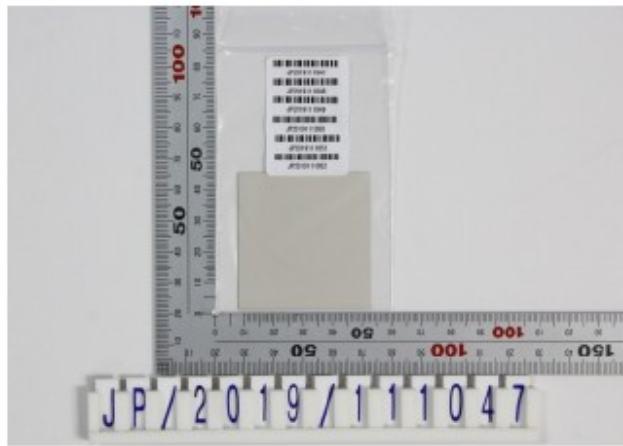

<END>

This Test Report is issued by the Company under its General Conditions of Service printed overleaf or available on request and accessible at <http://www.sgs.com>. Attention is drawn to the limitation of liability, indemnification and jurisdiction issues defined therein. Unless otherwise stated the results shown in this Test Report refer only to the sample(s) tested. This Test Report cannot be reproduced except in full, without prior approval of the Company. Any unauthorized alteration, forgery or falsification of the content or appearance of this test report is unlawful and offenders may be prosecuted to the fullest extent of the law. A

この検査報告書は裏面に記載された、もしくは<http://www.sgs.com>で入手可能なサービスに関する一般的条件に照して発行されます。さらに明記されている弊社の負うべき債務・補償の範囲及び責任免除の項目をご注意ください。他に無断での複製・改ざり、この検査報告書に記載された結果は、検査した試料のみに限ります。この書面全体の複製以外には、弊社からの事前の許可を得ること無く複製することを禁じます。この検査報告書を無断で変更、偽造、改ざんすることは違法であり、違反者に対しては法的手段を講ずることとなります。

SGS Japan Inc. YBP East Tower 12F, 134 Godo-cho Hodogaya-ku Yokohama 240-0005, Japan
t +81(0) 45 330 1100 f +81(0) 45 330 1108 URL: www.sgs.com

Member of the SGS Group (Société Générale de Surveillance)

13-3. RAW MATERIAL(LT WAFER)



Test Report

No. : CE/2019/B1562

Date : 2019/11/14

Page : 1 of 9

Shinetsu Chemical Co.,Ltd.

13-1, Isobe 2-chome, Annaka-shi, Gunma 379-0195 Japan

The following samples was/were submitted and identified by/on behalf of the applicant as :

Sample Submitted By : Shinetsu Chemical Co.,Ltd.
 Sample Description : BLT
 Lot No : 71554A
 Composition : Lithium Tantalate
 Sample Receiving Date : 2019/11/08
 Testing Period : 2019/11/08 to 2019/11/14

Test Requested :

- (1) As specified by client, with reference to RoHS 2011/65/EU Annex II and amending Directive (EU) 2015/863 to determine Cadmium, Lead, Mercury, Cr(VI), PBBs, PBDEs, DBP, BBP, DEHP, DIBP contents in the submitter sample(s).
- (2) Please refer to next pages for the other item(s).

Test Result(s) : Please refer to following pages.

Conclusion : (1) Based on the performed tests on submitted sample(s), the test results of Cadmium, Lead, Mercury, Cr(VI), PBBs, PBDEs, DBP, BBP, DEHP, DIBP comply with the limits as set by RoHS Directive (EU) 2015/863 amending Annex II to Directive 2011/65/EU.

 Troy Chang / Manager - Sec
 Signed for and behalf of
 SGS TAIWAN LTD.
 Chemical Laboratory - Taipei



This document is issued by the Company subject to its General Conditions of Service printed overleaf, available on request or accessible at <http://www.sgs.com/en/Terms-and-Conditions.aspx> and, for electronic format documents, subject to Terms and Conditions for Electronic Documents at <http://www.sgs.com/en/Terms-and-Conditions/terms-e-document>. Attention is drawn to the limitation of liability, indemnification and jurisdiction issues defined therein. Any holder of this document is advised that information contained herein reflects the Company's findings at the time of its intervention only and within the limits of client's instruction, if any. The Company's sole responsibility is to its Client and this document does not constitute parties to a transaction from exercising all their rights and obligations under the transaction documents. This document cannot be reproduced, except in full, without prior written approval of the Company. Any unauthorized alteration, forgery or falsification of the content or appearance of this document is unlawful and offenders may be prosecuted to the fullest extent of the law. Unless otherwise stated the results shown in this test report refer only to the sample(s) tested.

SGS TAIWAN LTD. 台灣檢驗科技股份有限公司 | 25, Wu Chuan 7th Road, New Taipei Industrial Park, Wu Ku District, New Taipei City, Taiwan 新北市五股區新五路七段25號
 +886 (02)2299 3030 +886 (02)2299 3237 www.sgs.com.tw

Member of the SGS Group



Test Report

No. : CE/2019/B1562

Date : 2019/11/14

Page : 2 of 9

Shinetsu Chemical Co.,Ltd.

13-1, Isobe 2-chome, Annaka-shi, Gunma 379-0195 Japan

Test Result(s)

PART NAME No.1 : SHEET

Test Item(s)	Unit	Method	MDL	Result	Limit
				No.1	
Cadmium (Cd)	mg/kg	With reference to IEC 62321-5 (2013) and performed by ICP-OES.	2	n.d.	100
Lead (Pb)	mg/kg	With reference to IEC 62321-5 (2013) and performed by ICP-OES.	2	n.d.	1000
Mercury (Hg)	mg/kg	With reference to IEC 62321-4:2013+AMD1:2017 and performed by ICP-OES.	2	n.d.	1000
Hexavalent Chromium Cr(VI)	mg/kg	With reference to IEC 62321-7-2 (2017) and performed by UV-VIS.	8	n.d.	1000
Sum of PBBs	mg/kg		-	n.d.	1000
Monobromobiphenyl	mg/kg		5	n.d.	-
Dibromobiphenyl	mg/kg		5	n.d.	-
Tribromobiphenyl	mg/kg		5	n.d.	-
Tetrabromobiphenyl	mg/kg		5	n.d.	-
Pentabromobiphenyl	mg/kg		5	n.d.	-
Hexabromobiphenyl	mg/kg		5	n.d.	-
Heptabromobiphenyl	mg/kg		5	n.d.	-
Octabromobiphenyl	mg/kg		5	n.d.	-
Nonabromobiphenyl	mg/kg		5	n.d.	-
Decabromobiphenyl	mg/kg	With reference to IEC 62321-8 (2015) and performed by GC/MS.	5	n.d.	-
Sum of PBDEs	mg/kg		-	n.d.	1000
Monobromodiphenyl ether	mg/kg		5	n.d.	-
Dibromodiphenyl ether	mg/kg		5	n.d.	-
Tribromodiphenyl ether	mg/kg		5	n.d.	-
Tetrabromodiphenyl ether	mg/kg		5	n.d.	-
Pentabromodiphenyl ether	mg/kg		5	n.d.	-
Hexabromodiphenyl ether	mg/kg		5	n.d.	-
Heptabromodiphenyl ether	mg/kg		5	n.d.	-
Octabromodiphenyl ether	mg/kg		5	n.d.	-
Nonabromodiphenyl ether	mg/kg		5	n.d.	-
Decabromodiphenyl ether	mg/kg		5	n.d.	-

This document is issued by the Company subject to its General Conditions of Service printed overleaf, available on request or accessible at <http://www.sgs.com/en/terms-and-conditions.aspx> and, for electronic format documents, subject to Terms and Conditions for Electronic Documents at <https://www.sgs.com/en/terms-and-conditions/terms-e-document>. Attention is drawn to the limitation of liability, indemnification and jurisdiction issues defined therein. Any holder of this document is advised that information contained herein reflects the Company's findings at the time of its intervention only and within the limits of client's instruction, if any. The Company's sole responsibility is to its Client and this document does not constitute parties to a transaction from exercising all their rights and obligations under the transaction documents. This document cannot be reproduced, except in full, without prior written approval of the Company. Any unauthorized alteration, forgery or falsification of the content or appearance of this document is unlawful and offenders may be prosecuted to the fullest extent of the law. Unless otherwise stated the results shown in this test report refer only to the sample(s) tested.

SGS TAIWAN LTD. 台灣檢驗科技股份有限公司

25, Wu Chuan 7th Road, New Taipei Industrial Park, Wu Ku District, New Taipei City, Taiwan 新北市五股區新北產業園區七路25號
+886 (02)2299 3339 +886 (02)2299 3337 www.sgs.com.tw

Member of the SGS Group



Test Report

No. : CE/2019/B1562

Date : 2019/11/14

Page : 3 of 9

Shinetsu Chemical Co.,Ltd.

13-1, Isobe 2-chome, Annaka-shi, Gunma 379-0195 Japan

Test Item(s)	Unit	Method	MDL	Result	Limit
				No.1	
DEHP (Di- (2-ethylhexyl) phthalate) (CAS No.: 117-81-7)	mg/kg	With reference to IEC 62321-8 (2017). Analysis was performed by GC/MS.	50	n.d.	1000
BBP (Butyl Benzyl phthalate) (CAS No.: 85-88-7)	mg/kg	With reference to IEC 62321-8 (2017). Analysis was performed by GC/MS.	50	n.d.	1000
DBP (Dibutyl phthalate) (CAS No.: 84-74-2)	mg/kg	With reference to IEC 62321-8 (2017). Analysis was performed by GC/MS.	50	n.d.	1000
DIBP (Di-isobutyl phthalate) (CAS No.: 84-89-5)	mg/kg	With reference to IEC 62321-8 (2017). Analysis was performed by GC/MS.	50	n.d.	1000
Halogen-Chlorine (Cl) (CAS No.: 22537-15-1)	mg/kg	With reference to BS EN 14582 (2016). Analysis was performed by IC.	50	n.d.	-
Halogen-Bromine (Br) (CAS No.: 10097-32-2)	mg/kg	With reference to BS EN 14582 (2016). Analysis was performed by IC.	50	n.d.	-
Antimony (Sb)	mg/kg	With reference to US EPA 3052 (1996). Analysis was performed by ICP-OES.	2	n.d.	-
Beryllium (Be)	mg/kg	With reference to US EPA 3052 (1996). Analysis was performed by ICP-OES.	2	n.d.	-

Note :

1. mg/kg = ppm ; 0.1wt% = 1000ppm
2. MDL = Method Detection Limit
3. n.d. = Not Detected = less than MDL
4. " - " = Not Regulated

This document is issued by the Company subject to its General Conditions of Service printed overleaf, available on request or accessible at <http://www.sgs.com/en/Terms-and-Conditions.aspx> and, for electronic format documents, subject to Terms and Conditions for Electronic Documents at <http://www.sgs.com/en/terms-and-conditions/terms-and-conditions>. Attention is drawn to the limitation of liability, indemnification and jurisdiction issues defined therein. Any holder of this document is advised that information contained therein reflects the Company's findings at the time of its intervention only and within the limits of client's instruction, if any. The Company's sole responsibility is to its Client and this document does not exonerate parties to a transaction from exercising all their rights and obligations under the transaction documents. This document cannot be reproduced, except in full, without prior written approval of the Company. Any unauthorized alteration, forgery or falsification of the content or appearance of this document is unlawful and offenders may be prosecuted to the fullest extent of the law. Unless otherwise stated the results shown in this test report refer only to the sample(s) tested.

SGS TAIWAN LTD. 台灣檢驗科技股份有限公司

 25, Wu Chuan 7th Road, New Taipei Industrial Park, Wu Ku District, New Taipei City, Taiwan/新北市新莊區吳川第七路25號
 +886 (0)22299 3939 +886 (0)22299 3237 www.sgs.com.tw

Member of the SGS Group



Test Report

No. : CE/2019/B1562

Date : 2019/11/14

Page : 4 of 9

Shinetsu Chemical Co.,Ltd.

13-1, Isobe 2-chome, Annaka-shi, Gunma 379-0195 Japan

Analytical flow chart of Heavy Metal

These samples were dissolved totally by pre-conditioning method according to below flow chart. (Cr⁶⁺ test method excluded)

- Technician : Rita Chen
- Supervisor: Troy Chang

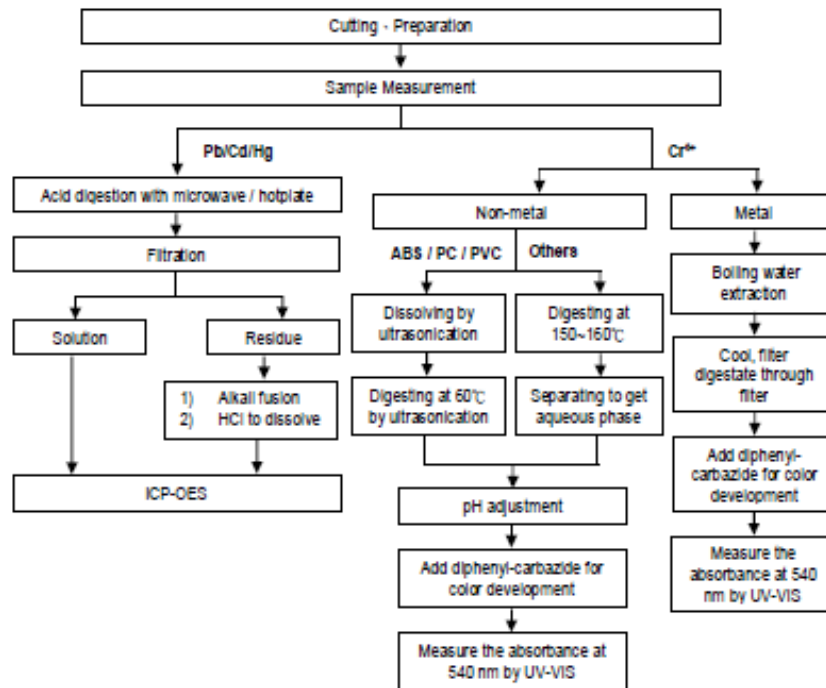

This document is issued by the Company subject to its General Conditions of Service printed overleaf, available on request or accessible at <http://www.sgs.com/en/Terms-and-Conditions.aspx> and, for electronic format documents, subject to Terms and Conditions for Electronic Documents at <http://www.sgs.com/en/terms-and-conditions/terms-and-conditions-document>. Attention is drawn to the limitation of liability, indemnification and jurisdiction issues defined therein. Any holder of this document is advised that information contained therein reflects the Company's findings at the time of its intervention only and within the limits of client's instruction, if any. The Company's sole responsibility is to its Client and this document does not exonerate parties to a transaction from exercising all their rights and obligations under the transaction documents. This document cannot be reproduced, except in full, without prior written approval of the Company. Any unauthorized alteration, forgery or falsification of the content or appearance of this document is unlawful and offenders may be prosecuted to the fullest extent of the law. Unless otherwise stated the results shown in this test report refer only to the sample(s) tested.

SGS Taiwan Ltd. 台灣檢驗科技股份有限公司

25, Wu Chuan 7th Road, New Taipei Industrial Park, Wu Ku District, New Taipei City, Taiwan 新北市立霧峰區立霧七路25號
+886 (0)22299 3939 +886 (0)2299 3237 www.sgs.com.tw

Member of the SGS Group



Test Report

No. : CE/2019/B1562

Date : 2019/11/14

Page : 5 of 9

Shinetsu Chemical Co.,Ltd.

13-1, Isobe 2-chome, Annaka-shi, Gunma 379-0195 Japan

Analytical flow chart – PBB / PBDE

- Technician : Yaling Tu
- Supervisor: Troy Chang

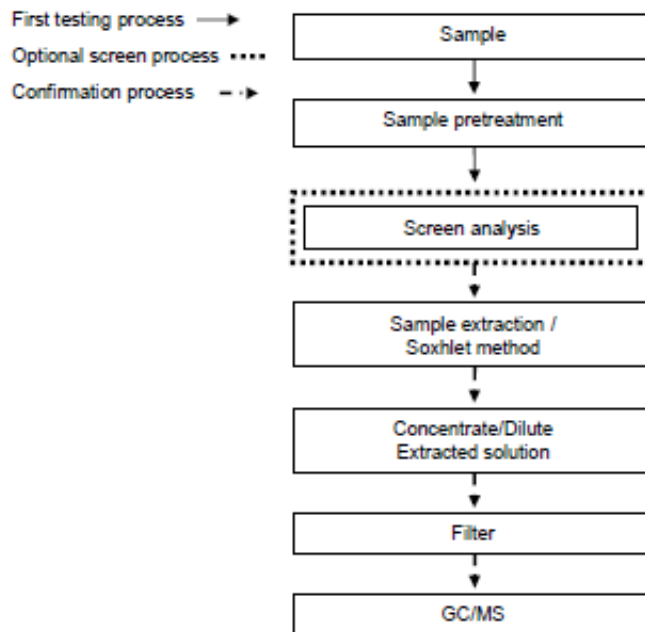

This document is issued by the Company subject to its General Conditions of Service printed overleaf, available on request or accessible at <http://www.sgs.com/en/terms-and-conditions.aspx> and, for electronic format documents, subject to Terms and Conditions for Electronic Documents at <https://www.sgs.com/en/terms-and-conditions/terms-e-document>. Attention is drawn to the limitation of liability, indemnification and jurisdiction issues defined therein. Any holder of this document is advised that information contained herein reflects the Company's findings at the time of its intervention only and within the limits of client's instruction, if any. The Company's sole responsibility is to its Client and this document does not exonerate parties to a transaction from exercising all their rights and obligations under the transaction documents. This document cannot be reproduced, except in full, without prior written approval of the Company. Any unauthorized alteration, forgery or falsification of the content or appearance of this document is unlawful and offenders may be prosecuted to the fullest extent of the law. Unless otherwise stated the results shown in this test report refer only to the sample(s) tested.

SGS Taiwan Ltd. 台灣檢驗科技股份有限公司

25, Wu Chuan 7th Road, New Taipei Industrial Park, Wu Ku District, New Taipei City, Taiwan 新北市五股區新五路七段25號
t+886 (02)299 3939 f+886 (02)299 3237 www.sgs.com.tw

Member of the SGS Group



Test Report

No. : CE/2019/B1562

Date : 2019/11/14

Page : 6 of 9

Shinetsu Chemical Co.,Ltd.

13-1, Isobe 2-chome, Annaka-shi, Gunma 379-0195 Japan

Analytical flow chart - Phthalate

- Technician: Yaling Tu
- Supervisor: Troy Chang

【 Test method: IEC 62321-8】

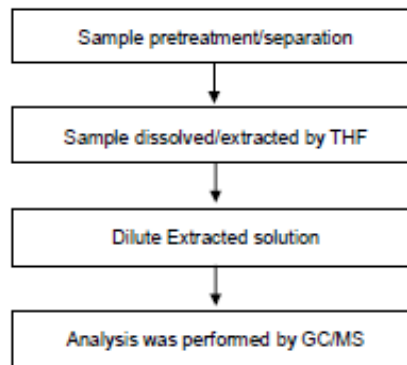

This document is issued by the Company subject to its General Conditions of Service printed overleaf, available on request or accessible at <http://www.sgs.com/en/terms-and-conditions.aspx> and, for electronic format documents, subject to Terms and Conditions for Electronic Documents at <http://www.sgs.com/en/terms-and-conditions/terms-e-document>. Attention is drawn to the limitation of liability, indemnification and jurisdiction issues defined therein. Any holder of this document is advised that information contained therein reflects the Company's findings at the time of its intervention only and within the limits of client's instruction, if any. The Company's sole responsibility is to its Client and this document does not exonerate parties to a transaction from exercising all their rights and obligations under the transaction documents. This document cannot be reproduced, except in full, without prior written approval of the Company. Any unauthorized alteration, forgery or falsification of the content or appearance of this document is unlawful and offenders may be prosecuted to the fullest extent of the law. Unless otherwise stated the results shown in this test report refer only to the sample(s) tested.

SGS TAIWAN LTD. 台灣檢驗科技股份有限公司

25, Wu Chuan 7th Road, New Taipei Industrial Park, Wu Ku District, New Taipei City, Taiwan 新北市五股區新北產業園區五權七路25號
t+886 (02)2299 3939 f+886 (02)2299 3237 www.sgs.com.tw

Member of the SGS Group



Test Report

No. : CE/2019/B1562

Date : 2019/11/14

Page : 7 of 9

Shinetsu Chemical Co.,Ltd.

13-1, Isobe 2-chome, Annaka-shi, Gunma 379-0195 Japan

Analytical flow chart - Halogen

- Technician: Rita Chen
- Supervisor: Troy Chang

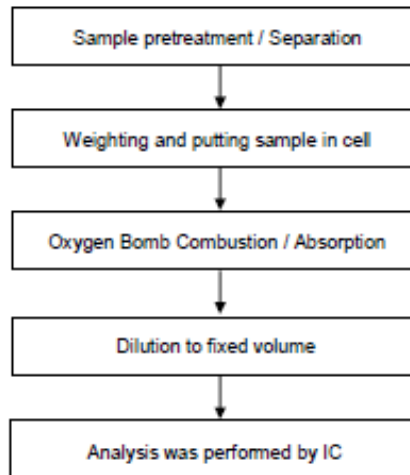

This document is issued by the Company subject to its General Conditions of Service printed overleaf, available on request or accessible at <http://www.sgs.com/en/Terms-and-Conditions.aspx> and, for electronic format documents, subject to Terms and Conditions for Electronic Documents at <https://www.sgs.com/en/terms-and-conditions/terms-and-conditions>. Attention is drawn to the limitation of liability, indemnification and jurisdiction issues defined therein. Any holder of this document is advised that information contained herein reflects the Company's findings at the time of its intervention only and within the limits of client's instruction, if any. The Company's sole responsibility is to its Client and this document does not exonerate parties to a transaction from exercising all their rights and obligations under the transaction documents. This document cannot be reproduced, except in full, without prior written approval of the Company. Any unauthorized alteration, forgery or falsification of the content or appearance of this document is unlawful and offenders may be prosecuted to the fullest extent of the law. Unless otherwise stated the results shown in this test report refer only to the sample(s) tested.

SGS TAIWAN LTD. 台灣檢驗科技股份有限公司

25, Wu Chuan 7th Road, New Taipei Industrial Park, Wu Ku District, New Taipei City, Taiwan 新北市立臥室新北產業園區立豐七路25號
+886 (0)2299 3039 +886 (0)2299 3237 www.sgs.com.tw

Member of the SGS Group



Test Report

No. : CE/2019/B1562

Date : 2019/11/14

Page : 8 of 9

Shinetsu Chemical Co.,Ltd.

13-1, Isobe 2-chome, Annaka-shi, Gunma 379-0195 Japan

These samples were dissolved totally by pre-conditioning method according to below flow chart.

- Technician: Rita Chen
- Supervisor: Troy Chang

Flow Chart of digestion for the elements analysis performed by ICP-OES

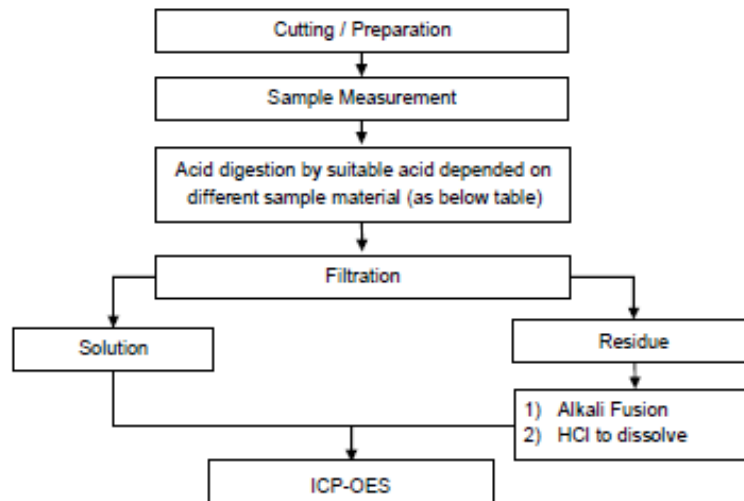

Steel, copper, aluminum, solder	Aqua regia, HNO ₃ , HCl, HF, H ₂ O ₂
Glass	HNO ₃ /HF
Gold, platinum, palladium, ceramic	Aqua regia
Silver	HNO ₃
Plastic	H ₂ SO ₄ , H ₂ O ₂ , HNO ₃ , HCl
Others	Added appropriate reagent to total digestion

This document is issued by the Company subject to its General Conditions of Service printed overleaf, available on request or accessible at <http://www.sgs.com/en/Terms-and-Conditions.aspx> and, for electronic format documents, subject to Terms and Conditions for Electronic Documents at <http://www.sgs.com/en/terms-and-conditions/terms-and-conditions>. Attention is drawn to the limitation of liability, indemnification and jurisdiction issues defined therein. Any holder of this document is advised that information contained herein reflects the Company's findings at the time of its intervention only and within the limits of client's instruction, if any. The Company's sole responsibility is to its Client and this document does not exonerate parties to a transaction from exercising all their rights and obligations under the transaction documents. This document cannot be reproduced, except in full, without prior written approval of the Company. Any unauthorized alteration, forgery or falsification of the content or appearance of this document is unlawful and offenders may be prosecuted to the fullest extent of the law. Unless otherwise stated the results shown in this test report refer only to the sample(s) tested.

SGS I3W30 LTD. 台灣檢驗科技股份有限公司

25, Wu Chuan 7th Road, New Taipei Industrial Park, Wu Ku District, New Taipei City, Taiwan 新北市五股區新五路七號
+886 (0)2299 3239 +886 (0)2299 3237 www.sgs.com.tw

Member of the SGS Group



Test Report

No. : CE/2019/B1562

Date : 2019/11/14

Page : 9 of 9

Shinetsu Chemical Co.,Ltd.

13-1, Isobe 2-chome, Annaka-shi, Gunma 379-0195 Japan

* The tested sample / part is marked by an arrow if it's shown on the photo. *

CE/2019/B1562

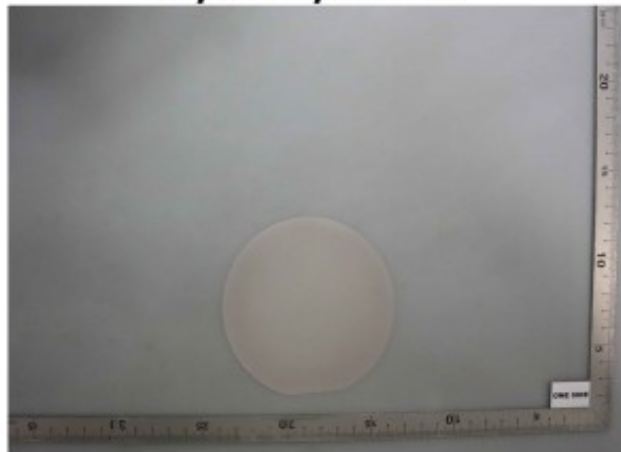

CE/2019/B1562

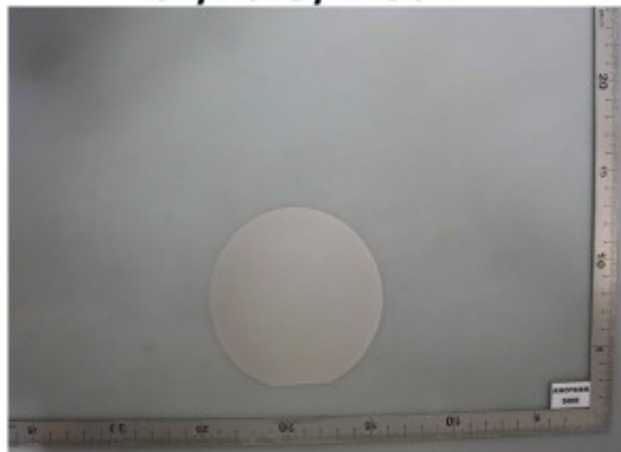

** End of Report **

This document is issued by the Company subject to its General Conditions of Service printed overleaf, available on request or accessible at <http://www.sgs.com/en/Terms-and-Conditions.aspx> and, for electronic format documents, subject to Terms and Conditions for Electronic Documents at <http://www.sgs.com/en/Terms-and-Conditions/Terms-e-Document>. Attention is drawn to the limitation of liability, indemnification and jurisdiction issues defined therein. Any holder of this document is advised that information contained therein reflects the Company's findings at the time of its intervention only and within the limits of client's instruction, if any. The Company's sole responsibility is to its Client and this document does not exonerate parties to a transaction from exercising all their rights and obligations under the transaction documents. This document cannot be reproduced, except in full, without prior written approval of the Company. Any unauthorized alteration, forgery or falsification of the content or appearance of this document is unlawful and offenders may be prosecuted to the fullest extent of the law. Unless otherwise stated the results shown in this test report refer only to the sample(s) tested.

SGS TAIWAN LTD. 台灣檢驗科技股份有限公司 | 25, Wu Chuan 7th Road, New Taipei Industrial Park, Wu Ku District, New Taipei City, Taiwan 新北市五股區新北產業園區五權七路25號
+886 (0)2299 3939 +886 (0)2299 3237 www.sgs.com.tw

Member of the SGS Group

13-4. RAW MATERIAL(GOLD WIRE)



TEST REPORT: No. CRSSA/190920848-CA19935 **REPORTED DATE:** 10/09/2019
Job Ref. CRS/2019-08-27-022

TANAKA ELECTRONICS (M) SDN BHD
PLOT 11, PHASE IV, BAYAN LEPAS FIZ,
11900, PENANG, MALAYSIA

The following sample(s) was/were submitted and identified by/on behalf of applicant as:

SAMPLE DESCRIPTION	: Au Bonding Wire
SAMPLE RECEIVED	: 27/08/2019
TESTING PERIOD	: 27/08/2019 to 10/09/2019
<hr/>	
TEST REQUESTED	: Selected test(s) as requested by customer
TEST METHOD	: -PLEASE REFER TO NEXT PAGE(S)-
TEST RESULTS	: -PLEASE REFER TO NEXT PAGE(S)-
REMARKS	: 1) This report supersede report no. : CRSSA/190920780-CA19935.

SIGNED FOR AND ON BEHALF OF
SGS (MALAYSIA) SDN BHD



TAY SIAM PINE
TECHNICAL MANAGER
IKM No. M/3452/6047/11/12

The Report Form No.: SGS/TPCR6003, Ver: 4.0, Effective Date: 10/01/2019

Page 1 of 15

This document is issued by the Company subject to its General Conditions of Service printed overleaf, available on request or accessible at <http://www.sgs.com/en/terms-and-conditions> and, for electronic format documents, subject to Terms and Conditions for Electronic Documents at <http://www.sgs.com/en/terms-and-conditions/e-documents>. Attention is drawn to the limitation of liability, indemnification and jurisdiction issues defined therein. Any holder of this document is advised that information contained herein reflects the Company's findings at the time of its intervention only and within the limits of Client's instructions, if any. The Company's sole responsibility is to its Client and this document does not exonerate parties to a transaction from exercising all their rights and obligations under the transaction documents. This document cannot be reproduced except in full, without prior written approval of the Company. Any unauthorized alteration, forgery or falsification of the content or appearance of this document is unlawful and offenders may be prosecuted to the fullest extent of the law. Unless otherwise stated the results shown in this test report refer only to the sample(s) tested and such sample(s) are retained for 14 days (for perishable samples) or 90 days only.

SGS (Malaysia) Sdn Bhd Lot 4, Persiaran Jubli Perak Seksyen 22, 40300 Shah Alam, Selangor Darul Ehsan, Malaysia.
(Company No. 10671-T) t +6 (03) 7827 0080 f +6 (03) 7827 0082 www.sgs.com

Member of the SGS Group (SGS SA)



TEST REPORT:

No. CRSSA/190920848-CA19935
Job Ref. CRS/2019-08-27-022

REPORTED DATE: 10/09/2019

TEST RESULTS:

Test Part Description

Sample Description: -PLEASE REFER TO PAGE 1-

RoHS Directive (EU) 2015/863 amending Annex II to Directive 2011/65/EU

Test Item(s)	Unit	Test Method	Result	MDL	Limit
Cadmium (Cd)	mg/kg	With reference to IEC 62321-5:2013, determination of Cadmium by ICP-OES.	N.D.	2	Max 100
Lead (Pb)	mg/kg	With reference to IEC 62321-5:2013, determination of Lead by ICP-OES.	N.D.	2	Max 1000
Mercury (Hg)	mg/kg	With reference to IEC 62321-4:2013+A1:2017, determination of Mercury by ICP-OES.	N.D.	2	Max 1000
Hexavalent Chromium (CrVI)	µg/cm ²	With reference to IEC 62321-7-1:2015, determination of Hexavalent Chromium by Colorimetric Method using UV-Vis.	N.D.	0.10	-
Hexavalent Chromium (CrVI)	mg/kg	With reference to JIS H 8625, determination of Hexavalent Chromium by Colorimetric Method using UV-Vis.	N.D.	2	Max 1000
Sum of PBBs	mg/kg	With reference to IEC 62321-6:2015, determination of PBBs and PBDEs by GC-MS.	N.D.	5	Max 1000
Monobromobiphenyl	mg/kg	With reference to IEC 62321-6:2015, determination of PBBs and PBDEs by GC-MS.	N.D.	5	-
Dibromobiphenyl	mg/kg	With reference to IEC 62321-6:2015, determination of PBBs and PBDEs by GC-MS.	N.D.	5	-
Tribromobiphenyl	mg/kg	With reference to IEC 62321-6:2015, determination of PBBs and PBDEs by GC-MS.	N.D.	5	-
Tetrabromobiphenyl	mg/kg	With reference to IEC 62321-6:2015, determination of PBBs and PBDEs by GC-MS.	N.D.	5	-
Pentabromobiphenyl	mg/kg	With reference to IEC 62321-6:2015, determination of PBBs and PBDEs by GC-MS.	N.D.	5	-
Hexabromobiphenyl	mg/kg	With reference to IEC 62321-6:2015, determination of PBBs and PBDEs by GC-MS.	N.D.	5	-
Heptabromobiphenyl	mg/kg	With reference to IEC 62321-6:2015, determination of PBBs and PBDEs by GC-MS.	N.D.	5	-
Octabromobiphenyl	mg/kg	With reference to IEC 62321-6:2015, determination of PBBs and PBDEs by GC-MS.	N.D.	5	-
Nonabromobiphenyl	mg/kg	With reference to IEC 62321-6:2015, determination of PBBs and PBDEs by GC-MS.	N.D.	5	-
Decabromobiphenyl	mg/kg	With reference to IEC 62321-6:2015, determination of PBBs and PBDEs by GC-MS.	N.D.	5	-

SIGNED FOR AND ON BEHALF OF
SGS (MALAYSIA) SDN BHD

TAY SIAM PINE
TECHNICAL MANAGER
IKM No. M/3452/6047/11/12



Test Report Form No. 9667/19/09/003, Ver. 4.0, Effective Date: 10/07/2019

Page 2 of 15

This document is issued by the Company subject to its General Conditions of Service printed overleaf, available on request or accessible at <http://www.sgs.com/en/terms-and-conditions> and, for electronic format documents, subject to Terms and Conditions for Electronic Documents at <http://www.sgs.com/en/terms-and-conditions/terms-e-document>. Attention is drawn to the limitation of liability, indemnification and jurisdiction issues defined therein. Any holder of this document is advised that information contained herein reflects the Company's findings at the time of its intervention only and within the limits of Client's instructions, if any. The Company's sole responsibility is to its Client and this document does not exonerate parties to a transaction from exercising all their rights and obligations under the transaction documents. This document cannot be reproduced except in full, without prior written approval of the Company. Any unauthorized alteration, forgery or falsification of the content or appearance of this document is unlawful and offenders may be prosecuted to the fullest extent of the law. Unless otherwise stated the results shown in this test report refer only to the sample(s) tested and such sample(s) are retained for 14 days (for perishable samples) or 90 days only.

SGS (Malaysia) Sdn Bhd
(Company No. 10671-1)

Lot 4, Persiaran Jubli Perak, Seksyen 22, 40300 Shah Alam, Selangor Darul Ehsan, Malaysia.
T +6(05) 7627 0080 F +6 (05) 7627 0082 www.sgs.com

Member of the SGS Group (SGS SA)



TEST REPORT: No. CRSSA/190920848-CA19935 REPORTED DATE: 10/09/2019
Job Ref. CRS/2019-08-27-022

TEST RESULTS:

Test Part Description

Sample Description: -PLEASE REFER TO PAGE 1-

RoHS Directive (EU) 2015/863 amending Annex II to Directive 2011/65/EU

Test Item(s):	Unit	Test Method	Result	MDL	Limit
Sum of PBDEs	mg/kg	With reference to IEC 62321-6:2015, determination of PBBs and PBDEs by GC-MS.	N.D.	5	Max 1000
Monobromodiphenyl ether	mg/kg	With reference to IEC 62321-6:2015, determination of PBBs and PBDEs by GC-MS.	N.D.	5	-
Dibromodiphenyl ether	mg/kg	With reference to IEC 62321-6:2015, determination of PBBs and PBDEs by GC-MS.	N.D.	5	-
Tribromodiphenyl ether	mg/kg	With reference to IEC 62321-6:2015, determination of PBBs and PBDEs by GC-MS.	N.D.	5	-
Tetrabromodiphenyl ether	mg/kg	With reference to IEC 62321-6:2015, determination of PBBs and PBDEs by GC-MS.	N.D.	5	-
Pentabromodiphenyl ether	mg/kg	With reference to IEC 62321-6:2015, determination of PBBs and PBDEs by GC-MS.	N.D.	5	-
Hexabromodiphenyl ether	mg/kg	With reference to IEC 62321-6:2015, determination of PBBs and PBDEs by GC-MS.	N.D.	5	-
Heptabromodiphenyl ether	mg/kg	With reference to IEC 62321-6:2015, determination of PBBs and PBDEs by GC-MS.	N.D.	5	-
Octabromodiphenyl ether	mg/kg	With reference to IEC 62321-6:2015, determination of PBBs and PBDEs by GC-MS.	N.D.	5	-
Nonabromodiphenyl ether	mg/kg	With reference to IEC 62321-6:2015, determination of PBBs and PBDEs by GC-MS.	N.D.	5	-
Decabromodiphenyl ether	mg/kg	With reference to IEC 62321-6:2015, determination of PBBs and PBDEs by GC-MS.	N.D.	5	-

Note : (a) mg/kg = ppm ; ug/kg = ppb (0.01 mg/kg = 10 ug/kg); 0.1wt% = 1000ppm
 (b) N.D. = Not Detected
 (c) MDL = Method Detection Limit
 (d) - = Not regulated
 (e) a. The sample is positive for CrVI if the CrVI concentration is greater than 0.13 µg/cm². The sample coating is considered to contain CrVI.
 b. The sample is negative for CrVI if CrVI is N.D. (concentration less than 0.10 µg/cm²). The coating is considered a non-CrVI based coating.
 c. The result between 0.10 µg/cm² and 0.13 µg/cm² is considered to be inconclusive - unavoidable coating variations may influence the determination.
 For corrosion protection coatings on metals: Information on storage conditions and production date of the tested sample is unavailable and thus results of Cr(VI) represent status of the sample at the time of testing.

SIGNED FOR AND ON BEHALF OF

SGS (MALAYSIA) SDN BHD

 TAY SIAM PINE
 TECHNICAL MANAGER
 IKM No. M/3452/6047/11/12



Test Report Form No. 9067/ROHS06/03, Ver. 4.0, Effective Date: 12/01/2019

Page 3 of 15

This document is issued by the Company subject to its General Conditions of Service printed overleaf, available on request or accessible at <https://sgs.com/en/terms-and-conditions> and, for electronic format documents, subject to Terms and Conditions for Electronic Documents at <https://www.sgs.com/en/terms-and-conditions/electronic-documents>. Attention is drawn to the limitation of liability, indemnification and jurisdiction issues defined therein. Any holder of this document is advised that information contained herein reflects the Company's findings at the time of its intervention only and within the limits of Client's instructions, if any. The Company's sole responsibility is to its Client and this document does not exonerate parties to a transaction from exercising all their rights and obligations under the transaction documents. This document cannot be reproduced except in full, without prior written approval of the Company. Any unauthorized alteration, forgery or falsification of the content or appearance of this document is unlawful and offenders may be prosecuted to the fullest extent of the law. Unless otherwise stated the results shown in this test report refer only to the sample(s) tested and such sample(s) are retained for 14 days (for perishable samples) or 90 days only.

SGS (Malaysia) Sdn Bhd
 (Company No. 10671-T)

Lot 4, Persiaran Jubli Perak Seksyen 22, 40300 Shah Alam, Selangor Darul Ehsan, Malaysia.
 T +6 (03) 7627 0060 F +6 (03) 7627 0082 www.sgs.com

Member of the SGS Group (SGS SA)



TEST REPORT: No. CRSSA/190920848-CA19935 **REPORTED DATE:** 10/09/2019
Job Ref. CRS/2019-08-27-022

TEST RESULTS:

Test Part Description

Sample Description: -PLEASE REFER TO PAGE 1-

Optional: RoHS Directive 2011/65/EU, priority substances

Test Item(s):	Unit	Test Method	Result	MDL
Hexabromocyclododecane (HBCDD)	mg/kg	In-house method, SGS-TM-RSTS-O-012, with reference to IEC 62321-6:2015	N.D.	5

Note : (a) Reference Information: Directive 2011/65/EU recasting RoHS directive 2002/95/EC: Hexabromocyclododecane (HBCDD), Bis (2-ethylhexyl) phthalate (DEHP), Butyl benzyl phthalate (BBP), Dibutyl phthalate (DBP) are considered as a priority for risk evaluation and substance restriction.
(b) N.D. = Not Detected

SIGNED FOR AND ON BEHALF OF
SGS (MALAYSIA) SDN BHD

TAY SIAM PINE
TECHNICAL MANAGER
IKM No. M/3452/6047/11/12



Test Report Form No. 969/92000070, Ver. 4.0, Effective Date: 12/01/2019

Page 4 of 15

This document is issued by the Company subject to its General Conditions of Service printed overleaf, available on request or accessible at <https://www.sgs.com/en/terms-and-conditions> and, for electronic format documents, subject to Terms and Conditions for Electronic Documents at <https://www.sgs.com/en/terms-and-conditions/e-documents>. Attention is drawn to the limitation of liability, indemnification and jurisdiction issues defined therein. Any holder of this document is advised that information contained hereon reflects the Company's findings at the time of its intervention only and within the limits of Client's instructions, if any. The Company's sole responsibility is to its Client and this document does not exonerate parties to a transaction from exercising all their rights and obligations under the transaction documents. This document cannot be reproduced except in full, without prior written approval of the Company. Any unauthorized alteration, forgery or falsification of the content or appearance of this document is unlawful and offenders may be prosecuted to the fullest extent of the law. Unless otherwise stated the results shown in this test report refer only to the sample(s) tested and such sample(s) are retained for 14 days (for perishable samples) or 90 days only.

SGS (Malaysia) Sdn Bhd
(Company No. 10671-T)

Lot 4, Pejabatan Jubli Perak, Seksyen 22, 40300 Shah Alam, Selangor Darul Ehsan, Malaysia.
t +6(03) 7627 0080 f +6 (03) 7627 0082 www.sgs.com

Member of the SGS Group (SGS SA)



TEST REPORT: No. CRSSA/190920848-CA19935 **REPORTED DATE:** 10/09/2019
Job Ref. CRS/2019-08-27-022

TEST RESULTS:

Test Part Description

Sample Description: -PLEASE REFER TO PAGE 1-

RoHS Directive (EU) 2015/863 amending Annex II to Directive 2011/65/EU

Test Item(s):	Unit	Test Method	Result	MDL	Limit
Dibutyl phthalate (DBP) (CAS No. 84-74-2)	mg/kg	With reference to IEC 62321-8:2017, determination of phthalates by GC-MS.	N.D.	50	Max 1000
Di(2-ethylhexyl) phthalate (DEHP) (CAS No. 117-81-7)	mg/kg	With reference to IEC 62321-8:2017, determination of phthalates by GC-MS.	N.D.	50	Max 1000
Benzyl butyl phthalate (BBP) (CAS No. 85-68-7)	mg/kg	With reference to IEC 62321-8:2017, determination of phthalates by GC-MS.	N.D.	50	Max 1000
Dilisobutyl phthalate (DIBP) (CAS No. 84-69-5)	mg/kg	With reference to IEC 62321-8:2017, determination of phthalates by GC-MS.	N.D.	50	Max 1000

- Note : (a) mg/kg = ppm ; ug/kg = ppb (0.01 mg/kg = 10 ug/kg); 0.1wt% = 1000ppm
 (b) N.D. = Not Detected
 (c) MDL = Method Detection Limit
 (d) - = Not regulated
 (e) On 4 June 2015, Commission Directive (EU) 2015/863 was published in the Official Journal of the European Union (OJEU) to include the phthalates BBP, DBP, DEHP and DIBP into ANNEX II of the RoHS Recast Directive. The new law restricts each phthalate to no more than 0.1% in each homogeneous material of an electrical product.
 (f) The restriction of DEHP, BBP, DBP and DIBP shall apply to medical devices, including in vitro medical devices, and monitoring and control instruments, including industrial monitoring and control instruments, from 22 July 2021.
 (g) The restriction of DEHP, BBP, DBP and DIBP shall not apply to cables or spare parts for the repair, the reuse, the updating of functionalities or upgrading of capacity of EEE placed on the market before 22 July 2019, and of medical devices, including in vitro medical devices, and monitoring and control instruments, including industrial monitoring and control instruments, placed on the market before 22 July 2021.
 (h) The restriction of DEHP, BBP and DBP shall not apply to toys which are already subject to the restriction of DEHP, BBP and DBP through entry 51 of Annex XVII to Regulation (EC) No 1907/2006.

SIGNED FOR AND ON BEHALF OF
SGS (MALAYSIA) SDN BHD

TAY SIAM PINE
TECHNICAL MANAGER
IKM No. M/3452/6047/11/12



Test Report Form No. 903/19CRS(01), Ver. 4.0, Effective Date: 10/07/2019

Page 5 of 15

This document is issued by the Company subject to its General Conditions of Service printed overleaf, available on request or accessible at <https://www.sgs.com/en/terms-and-conditions> and, for electronic format documents, subject to Terms and Conditions for Electronic Documents at <https://www.sgs.com/en/terms-and-conditions/electronic-documents>. Attention is drawn to the limitation of liability, indemnification and jurisdiction issues defined therein. Any holder of this document is advised that information contained herein reflects the Company's findings at the time of its intervention only and within the limits of Client's instructions, if any. The Company's sole responsibility is to its Client and this document does not exonerate parties to a transaction from exercising all their rights and obligations under the transaction documents. This document cannot be reproduced except in full, without prior written approval of the Company. Any unauthorized alteration, forgery or falsification of the content or appearance of this document is unlawful and offenders may be prosecuted to the fullest extent of the law. Unless otherwise stated the results shown in this test report refer only to the sample(s) tested and such sample(s) are retained for 14 days (for perishable samples) or 90 days only.

SGS (Malaysia) Sdn Bhd (Company No. 10671-T) | Lot 4, Persiaran Jubli Perak Seksyen 22, 40300 Shah Alam, Selangor Darul Ehsan, Malaysia.
T+6(05) 7627 0080 F+6 (03) 7627 0082 www.sgs.com

Member of the SGS Group (SGS SA)



TEST REPORT: No. CRSSA/190920848-CA19035 REPORTED DATE: 10/09/2019
Job Ref. CRS/2019-08-27-022

TEST RESULTS BY CHEMICAL METHOD:

Test Part Description

Sample Description: -PLEASE REFER TO PAGE 1-

Test Item(s):	Unit	Test Method	Result	MDL
Dimethyl Fumarate (CAS No.:624-49-7)	mg/kg	In-house method, SGS-TM-RSTS-O-005, with reference to RSTS-CHEM-233-1. Analysis performed by GC-MS	N.D.	0.1
Polyvinylchloride (PVC)	-	Analysis was performed by FTIR and FLAME Test	N.D.	-
Antimony (Sb)	mg/kg	With reference to EPA Method 3051A, and performed by ICP-OES.	N.D.	2
Beryllium (Be)	mg/kg	With reference to EPA Method 3051A, and performed by ICP-OES.	10	2
Magnesium (Mg)	mg/kg	With reference to EPA Method 3051A, and performed by ICP-OES.	N.D.	20
Arsenic (As)	mg/kg	With reference to EPA Method 3051A, and performed by ICP-OES.	N.D.	2
Halogen	-	-	-	-
Halogen-Fluorine (F)	mg/kg	With reference to BS EN 14582:2016, analysis performed by IC method for Fluorine content.	N.D.	50
Halogen-Chlorine (Cl)	mg/kg	With reference to BS EN 14582:2016, analysis performed by IC method for Chlorine content.	N.D.	50
Halogen-Bromine (Br)	mg/kg	With reference to BS EN 14582:2016, analysis performed by IC method for Bromine content.	N.D.	50
Halogen-Iodine (I)	mg/kg	With reference to BS EN 14582:2016, analysis performed by IC method for Iodine content.	N.D.	50

Note : (a) mg/kg = ppm ; ug/kg = ppb (0.01 mg/kg = 10 ug/kg); 0.1wt% = 1000ppm
(b) N.D. = Not Detected
(c) MDL = Method Detection Limit
(d) Negative = Undetectable / Positive = Detectable

SIGNED FOR AND ON BEHALF OF
SGS (MALAYSIA) SDN BHD



TAY SIAM PINE
TECHNICAL MANAGER
IKM No. M/3452/6047/11/12

The Report Form No. SGS/RCR0303, Ver. 4.0, Effective Date: 12/01/2019

Page 6 of 15

This document is issued by the Company subject to its General Conditions of Service printed overleaf, available on request or accessible at <https://www.sgs.com/en/terms-and-conditions> and, for electronic format documents, subject to Terms and Conditions for Electronic Documents at <https://www.sgs.com/en/terms-and-conditions/for-electronic-documents>. Attention is drawn to the limitation of liability, indemnification and jurisdiction issues defined therein. Any holder of this document is advised that information contained herein reflects the Company's findings at the time of its intervention only and within the limits of Client's instructions, if any. The Company's sole responsibility is to its Client and this document does not exonerate parties to a transaction from exercising all their rights and obligations under the transaction documents. This document cannot be reproduced except in full, without prior written approval of the Company. Any unauthorized alteration, forgery or falsification of the content or appearance of this document is unlawful and offenders may be prosecuted to the fullest extent of the law. Unless otherwise stated the results shown in this test report refer only to the sample(s) tested and such sample(s) are retained for 14 days (for perishable sample) or 90 days only.

SGS (Malaysia) Sdn Bhd | Lot 4, Precinct Jabil Perak Seksyen 22, 40300 Shah Alam, Selangor Darul Ehsan, Malaysia.
(Company No. 10671-T) | t+6(03) 7627 0080 f+6(03) 7627 0082 www.sgs.com

Member of the SGS Group (SGS SA)



TEST REPORT:

No. CRSSA/190920848-CA19935
Job Ref. CRS/2019-08-27-022

REPORTED DATE: 10/09/2019

TEST RESULTS BY CHEMICAL METHOD:

Test Part Description

Sample Description: -PLEASE REFER TO PAGE 1-

Test Item(s):	Unit	Test Method	Result	MDL
Phthalates	-	-	-	-
Dibutyl phthalate (DBP) (CAS No. 84-74-2)	mg/kg	With reference to EN14372:2004, determination of phthalates by GC-MS.	N.D.	30
Di(2-ethylhexyl) phthalate (DEHP) (CAS No. 117-81-7)	mg/kg	With reference to EN14372:2004, determination of phthalates by GC-MS.	N.D.	30
Di-n-octyl phthalate (DNOP) (CAS No. 117-84-0)	mg/kg	With reference to EN14372:2004, determination of phthalates by GC-MS.	N.D.	30
Di-isononyl phthalate (DINP)(CAS No.: 26553-12-0,68515-48-	mg/kg	With reference to EN14372:2004, determination of phthalates by GC-MS.	N.D.	100
Di-isodecyl phthalate (DIDP)(CAS No.: 26761-40-0,68515-49-	mg/kg	With reference to EN14372:2004, determination of phthalates by GC-MS.	N.D.	100
Benzyl butyl phthalate (BBP) (CAS No. 85-68-7)	mg/kg	With reference to EN14372:2004, determination of phthalates by GC-MS.	N.D.	30
Di-n-hexyl phthalate (DnHP/DHEXP) (CAS No. 84-75-3)	mg/kg	With reference to EN14372:2004, determination of phthalates by GC-MS.	N.D.	30
Bis(2-methoxyethyl) phthalate (DMEP) (CAS No.:117-82-8)	mg/kg	Based on EN 14372: 2004, and performed by GC-MS	N.D.	30
Diisobutyl phthalate (DIBP) (CAS No. 84-59-5)	mg/kg	With reference to EN14372:2004, determination of phthalates by GC-MS.	N.D.	30

SIGNED FOR AND ON BEHALF OF
SGS (MALAYSIA) SDN BHD

TAY SIAM PINE
TECHNICAL MANAGER

IKM No. M/3452/6047/11/12

Test Report Form No.: 906/1702/CRS003, Ver. 4.0, Effective Date: 12/01/2019



Page 7 of 15

This document is issued by the Company subject to its General Conditions of Service printed overleaf, available on request or accessible at <http://www.sgs.com/en/terms-and-conditions> and, for electronic format documents, subject to Terms and Conditions for Electronic Documents at <http://www.sgs.com/en/terms-and-conditions/electronic-documents>. Attention is drawn to the limitation of liability, indemnification and jurisdiction issues defined therein. Any holder of this document is advised that information contained herein reflects the Company's findings at the time of its intervention only and within the limits of Client's instructions, if any. The Company's sole responsibility is to its Client and this document does not exonerate parties to a transaction from exercising all their rights and obligations under the transaction documents. This document cannot be reproduced except in full, without prior written approval of the Company. Any unauthorized alteration, forgery or falsification of the content or appearance of this document is unlawful and offenders may be prosecuted to the fullest extent of the law. Unless otherwise stated the results shown in this test report refer only to the sample(s) tested and such sample(s) are retained for 14 days (for perishable samples) or 90 days only.

SGS (Malaysia) Sdn Bhd (Company No. 10671-T) | Lot 4, Pempayan, Jubli Perk Sekoyan 22, 40300 Shah Alam, Selangor Darul Ehsan, Malaysia. | T +6(03) 7627 0060 F +6 (03) 7627 0062 www.sgs.com

Member of the SGS Group (SGS SA)

TEST REPORT:

No. CRSSA/190920848-CA19935

REPORTED DATE: 10/09/2019

Job Ref. CRS/2019-08-27-022

Note : (a) mg/kg = ppm ; ug/kg = ppb (0.01 mg/kg = 10 ug/kg); 0.1wt% = 1000ppm

(b) N.D. = Not Detected

(c) MDL = Method Detection Limit

(d) On 4 June 2015, Commission Directive (EU) 2015/863 was published in the Official Journal of the European Union (OJEU) to include the phthalates BBP, DBP, DEHP and DIBP into ANNEX II of the RoHS Recast Directive. The new law restricts each phthalate to no more than 0.1% in each homogeneous material of an electrical product.

(e) The restriction of DEHP, BBP, DBP and DIBP shall apply to medical devices, including in vitro medical devices, and monitoring and control instruments, including industrial monitoring and control instruments, from 22 July 2021.

(f) The restriction of DEHP, BBP, DBP and DIBP shall not apply to cables or spare parts for the repair, the reuse, the updating of functionalities or upgrading of capacity of EEE placed on the market before 22 July 2019, and of medical devices, including in vitro medical devices, and monitoring and control instruments, including industrial monitoring and control instruments, placed on the market before 22 July 2021.

(g) The restriction of DEHP, BBP and DBP shall not apply to toys which are already subject to the restriction of DEHP, BBP and DBP through entry 51 of Annex XVII to Regulation (EC) No 1907/2006.

 SIGNED FOR AND ON BEHALF OF
 SGS (MALAYSIA) SDN BHD



 TAY SIAM PINE
 TECHNICAL MANAGER

IKM No. M/3452/6047/11/12

Test Report Form No. 808/19(08/03), Ver. 4.0, Effective Date: 10/01/2019

Page 8 of 15

This document is issued by the Company subject to its General Conditions of Service printed overleaf, available on request or accessible at <https://www.sgs.com/en/terms-and-conditions> and, for electronic format documents, subject to Terms and Conditions for Electronic Documents at <https://www.sgs.com/en/terms-and-conditions/sgs-electronic-documents>. Attention is drawn to the limitation of liability, indemnification and jurisdiction issues defined therein. Any holder of this document is advised that information contained herein reflects the company's findings at the time of its intervention only and within the limits of Client's instructions, if any. The Company's sole responsibility is to its Client and this document does not exonerate parties to a transaction from exercising all their rights and obligations under the transaction documents. This document cannot be reproduced except in full, without prior written approval of the Company. Any unauthorized alteration, forgery or falsification of the content or appearance of this document is unlawful and offenders may be prosecuted to the fullest extent of the law. Unless otherwise stated the results shown in this test report refer only to the sample(s) tested and such sample(s) are retained for 14 days (for perishable samples) or 90 days only.

 SGS (Malaysia) Sdn Bhd
 (Company No. 15671-T)

 Lot 4, Persiaran Jubli Perak Seksyen 22, 40300 Shah Alam, Selangor Darul Ehsan, Malaysia.
 T +6(03) 7827 0080 F +6 (03) 7827 0082 www.sgs.com

Member of the SGS Group (SGS SA)



TEST REPORT: No. CRSSA/190920848-CA19935 **REPORTED DATE:** 10/09/2019
Job Ref. CRS/2019-08-27-022

TEST RESULTS:

Test Part Description

Sample Description: -PLEASE REFER TO PAGE 1-

Test Method: CEN/TS 15968:2010

Test Item(s):	Result (%)	Max. Limit (µg/m ²) (Textile/Coated material)	Max.Limit(%) (Plastic)	Max. Limit(%) (Substances/ In mixtures)
Perfluorooctanesulfonic acid (PFOS)	N.D.	1	0.1	0.001
Perfluorooctanoic acid (PFOA) (CAS No. 335-67-1)	N.D.	/	/	/
Conclusion	Pass			

Note: (a) N.D. = Not Detected
(b) Detection limit = 1 µg/m² for Textile / Coated Material
= 0.001% for Plastic, substances or mixtures
(c) Max. limit specified by commission regulation (EU) No. 757/2010 amending Regulation (EC) No. 850/2004
(previously restricted under entry 53 of Regulation (EC) No 552/2009 amending Annex XVII of REACH Regulation
(EC) No 1907/2006).
(d) PFOS refers to Perfluorooctanesulfonic acid and its derivatives including Perfluorooctanesulfonic acid,
Perfluorooctane sulfonamide, N-Methylperfluorooctane sulfonamide, N-Ethylperfluorooctane sulfonamide, N-
Methylperfluorooctane sulfonamidoethanol and N-Ethylperfluorooctane sulfonamidoethanol.

SIGNED FOR AND ON BEHALF OF
SGS (MALAYSIA) SDN BHD



TAY SIAM PINE
TECHNICAL MANAGER
IKM No. M/3452/6047/11/12

Test Report Form No.: 968/19/CRS003, Ver. 4.0, Effective Date: 12/01/2019

This document is issued by the Company subject to its General Conditions of Service printed overleaf, available on request or accessible at <https://www.sgs.com/en/terms-and-conditions> and, for electronic format documents, subject to Terms and Conditions for Electronic Documents at <https://www.sgs.com/en/terms-and-conditions/e-documents>. Attention is drawn to the limitation of liability, indemnification and jurisdiction issues defined therein. Any holder of this document is advised that information contained hereon reflects the Company's findings at the time of its intervention only and within the limits of Client's instructions, if any. The Company's sole responsibility is to its Client and this document does not exonerate parties to a transaction from exercising all their rights and obligations under the transaction documents. This document cannot be reproduced except in full, without prior written approval of the Company. Any unauthorized alteration, forgery or falsification of the content or appearance of this document is unlawful and offenders may be prosecuted to the fullest extent of the law. Unless otherwise stated the results shown in this test report refer only to the sample(s) tested and such sample(s) are retained for 14 days (for perishable samples) or 90 days only.



TEST REPORT:

No. CRSSA/190920848-CA19935
Job Ref. CRS/2019-08-27-022

REPORTED DATE: 10/09/2019

Test Part Description :

Sample Description: -PLEASE REFER TO PAGE 1-

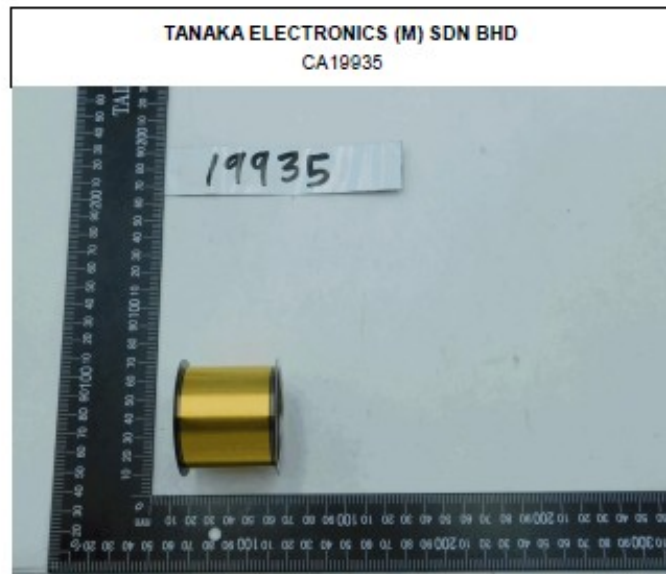

SGS authenticate the photo on original report only

SIGNED FOR AND ON BEHALF OF
SGS (MALAYSIA) SDN BHD

TAY SIAM PINE
TECHNICAL MANAGER

IKM No. M/3452/6047/11/12

The Report Form No. SGS/TKCRS003, Ver. 4.0, Effective Date: 10/01/2019

Page 10 of 15

This document is issued by the Company subject to its General Conditions of Service printed overleaf, available on request or accessible at <http://www.sgs.com/en/terms-and-conditions> and, for electronic format documents, subject to Terms and Conditions for Electronic Documents at <http://www.sgs.com/en/terms-and-conditions/electronic>. Attention is drawn to the limitation of liability, indemnification and jurisdiction issues defined therein. Any holder of this document is advised that information contained herein reflects the Company's findings at the time of its intervention only and within the limits of Client's instructions, if any. The Company's sole responsibility is to its Client and this document does not exonerate parties to a transaction from exercising all their rights and obligations under the transaction documents. This document cannot be reproduced except in full, without prior written approval of the Company. Any unauthorized alteration, forgery or falsification of the content or appearance of this document is unlawful and offenders may be prosecuted to the fullest extent of the law. Unless otherwise stated the results shown in this test report refer only to the sample(s) tested and such sample(s) are retained for 14 days (for perishable samples) or 90 days only.

SGS (Malaysia) Sdn Bhd
(Company No. 10671-T)

Lot 4, Precinct 5, Jln Perak Seksyen 22, 40300 Shah Alam, Selangor Darul Ehsan, Malaysia.
t +6(03) 7627 0080 f +6 (03) 7627 0082 www.sgs.com

Member of the SGS Group (SGS SA)



TEST REPORT:

No. CRSSA/190920848-CA19935
Job Ref. CRS/2019-08-27-022

REPORTED DATE: 10/09/2019

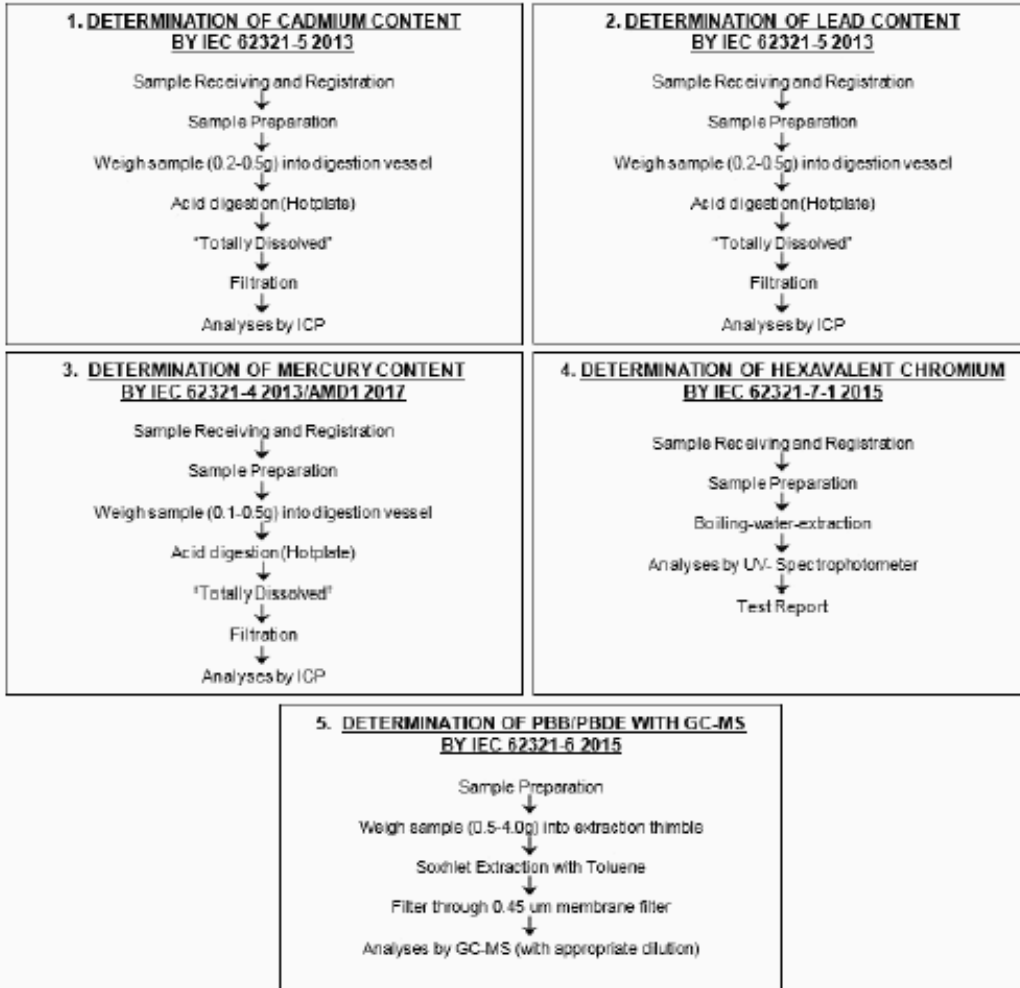

SIGNED FOR AND ON BEHALF OF
SGS (MALAYSIA) SDN BHD

TAY SIAM PINE
TECHNICAL MANAGER
IKM No. M/3452/6047/11/12



Test Report Form No.: 806/19/CRS(02), Ver. 4.0, Effective Date: 10/01/2019

Page 11 of 15

This document is issued by the Company subject to its General Conditions of Service printed overleaf, available on request or accessible at <http://www.sgs.com/en/terms-and-conditions> and, for electronic format documents, subject to Terms and Conditions for Electronic Documents at <http://www.sgs.com/en/terms-and-conditions/terms-electronic-documents>. Attention is drawn to the limitation of liability, indemnification and jurisdiction issue defined therein. Any holder of this document is advised that information contained herein reflects the company's findings at the time of its intervention only and within the limits of Client's instructions, if any. The Company's sole responsibility is to its Client and this document does not exonerate parties to a transaction from exercising all their rights and obligations under the transaction documents. This document cannot be reproduced except in full, without prior written approval of the Company. Any unauthorized alteration, forgery or falsification of the content or appearance of this document is unlawful and offenders may be prosecuted to the fullest extent of the law. Unless otherwise stated the results shown in this test report refer only to the sample(s) tested and such sample(s) are retained for 14 days (for perishable samples) or 90 days only.

SGS (Malaysia) Sdn Bhd (Company No. 10671-T) | Lot 4, Pengajaran, Jabil Perak Bekayon 22, 40300 Shah Alam, Selangor Darul Ehsan, Malaysia.
T +6(03) 7827 0080 F +6 (03) 7827 0082 www.sgs.com

Member of the SGS Group (SGS SA)



TEST REPORT:

No. CRSSA/190920848-CA19935
Job Ref. CRS/2019-08-27-022

REPORTED DATE: 10/09/2019

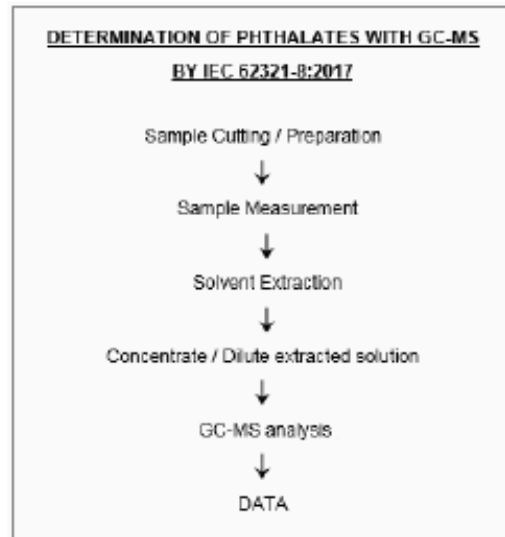
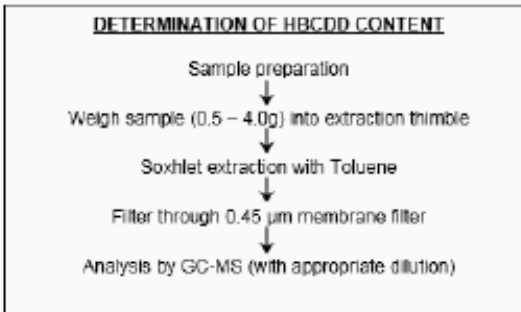

SIGNED FOR AND ON BEHALF OF
SGS (MALAYSIA) SDN BHD

TAY SIAM PINE
TECHNICAL MANAGER
IKM No. M/3452/6047/11/12



The Report Form No.: 966/PR/CR603, Ver. 4.0, Effective Date: 13/01/2019

Page 12 of 15

This document is issued by the Company subject to its General Conditions of Service printed overleaf, available on request or accessible at <https://www.sgs.com/en/terms-and-conditions> and, for electronic format documents, subject to Terms and Conditions for Electronic Documents at <https://www.sgs.com/en/terms-and-conditions/e-document>. Attention is drawn to the limitation of liability, indemnification and jurisdiction issues defined therein. Any holder of this document is advised that information contained herein reflects the Company's findings at the time of its intervention only and within the limits of Client's instructions, if any. The Company's sole responsibility is to its Client and this document does not exonerate parties to a transaction from exercising all their rights and obligations under the transaction documents. This document cannot be reproduced except in full, without prior written approval of the Company. Any unauthorized alteration, forgery or falsification of the content or appearance of this document is unlawful and offenders may be prosecuted to the fullest extent of the law. Unless otherwise stated the results shown in this test report refer only to the sample(s) tested and such sample(s) are retained for 14 days (for perishable samples) or 90 days only.

SGS (Malaysia) Sdn Bhd (Company No. 10871-T) Lot 4, Persiaran Jubli Perak Seksyen 22, 40300 Shah Alam, Selangor Darul Ehsan, Malaysia.
T +6 (03) 7827 0080 F +6 (03) 7827 0082 www.sgs.com

Member of the SGS Group (SGS SA)



TEST REPORT:

No. CRSSA/190920848-CA19935
Job Ref. CRS/2019-08-27-022

REPORTED DATE: 10/09/2019

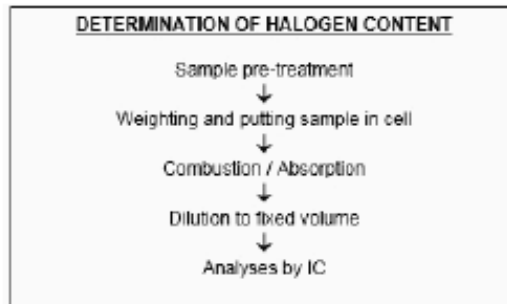
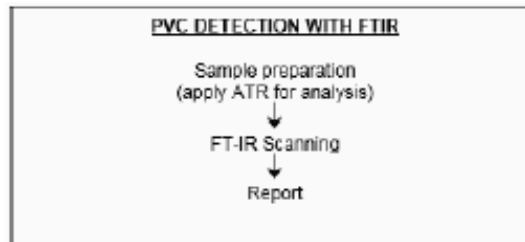
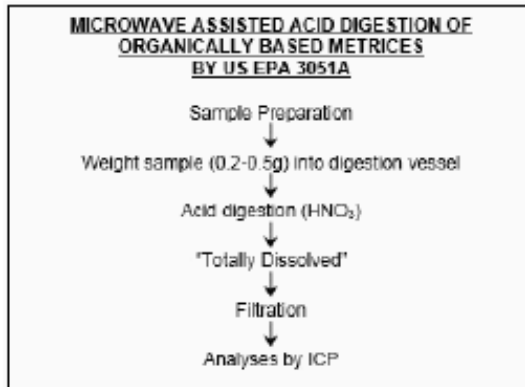

SIGNED FOR AND ON BEHALF OF
SGS (MALAYSIA) SDN BHD

TAY SIAM PINE
TECHNICAL MANAGER
IKM No. M/3452/6047/11/12



Test Report Form No.: 9068/PCOR0013, Ver: 4.0, Effective Date: 10/01/2019

Page 13 of 15

This document is issued by the Company subject to its General Conditions of Service printed overleaf, available on request or accessible at <https://www.sgs.com/en/terms-and-conditions> and, for electronic format documents, subject to Terms and Conditions for Electronic Documents at <https://www.sgs.com/en/terms-and-conditions/terms-a-conditions>. Attention is drawn to the limitation of liability, indemnification and jurisdiction issues defined therein. Any holder of this document is advised that information contained hereon reflects the Company's findings at the time of its intervention only and within the limits of Client's instructions, if any. The Company's sole responsibility is to its Client and this document does not exonerate parties to a transaction from exercising all their rights and obligations under the transaction documents. This document cannot be reproduced except in full, without prior written approval of the Company. Any unauthorized alteration, forgery or falsification of the content or appearance of this document is unlawful and offenders may be prosecuted to the fullest extent of the law. Unless otherwise stated the results shown in this test report refer only to the sample(s) tested and such sample(s) are retained for 14 days (for perishable samples) or 90 days only.



TEST REPORT:

No. CRSSA/190920848-CA19935
Job Ref. CRS/2019-08-27-022

REPORTED DATE: 10/09/2019

DETERMINATION OF DIMETHYL FUMARATE

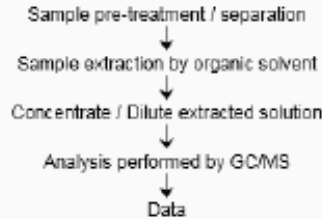

DETERMINATION OF PHTHALATES CONTENT

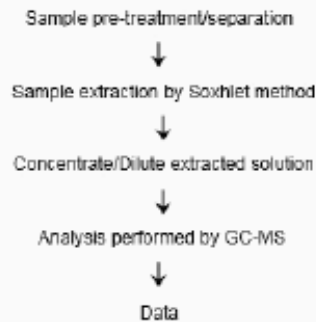

SIGNED FOR AND ON BEHALF OF
SGS (MALAYSIA) SDN BHD

TAY SIAM PINE
TECHNICAL MANAGER ★
IKM No. M/3452/6047/11/12



Test Report Form No. SGS/TCR08070, Ver. 4.0, Effective Date: 10/07/2019

Page 14 of 15

This document is issued by the Company subject to its General Conditions of Service printed overleaf, available on request or accessible at <http://www.sgs.com/en/terms-and-conditions> and, for electronic format documents, subject to Terms and Conditions for Electronic Documents at <http://www.sgs.com/en/terms-and-conditions/electronic-documents>. Attention is drawn to the limitation of liability, indemnification and jurisdiction issues defined therein. Any holder of this document is advised that information contained herein reflects the Company's findings at the time of its intervention only and within the limits of Client's instructions, if any. The Company's sole responsibility is to its Client and this document does not exonerate parties to a transaction from exercising all their rights and obligations under the transaction documents. This document cannot be reproduced except in full, without prior written approval of the Company. Any unauthorized alteration, forgery or falsification of the content or appearance of this document is unlawful and offenders may be prosecuted to the fullest extent of the law. Unless otherwise stated the results shown in this test report refer only to the sample(s) tested and such sample(s) are retained for 14 days (for perishable samples) or 90 days only.

SGS (Malaysia) Sdn Bhd
(Company No. 15671-T)

Lot 4, Persiaran Jubli Perak Seksyen 22, 40300 Shah Alam, Selangor Darul Ehsan, Malaysia.
T +6(03) 7827 0080 F +6 (03) 7827 0082 www.sgs.com

Member of the SGS Group (SGS SA)



TEST REPORT:

No. CRSSA/190920848-CA19935
Job Ref. CRS/2019-08-27-022

REPORTED DATE: 10/09/2019

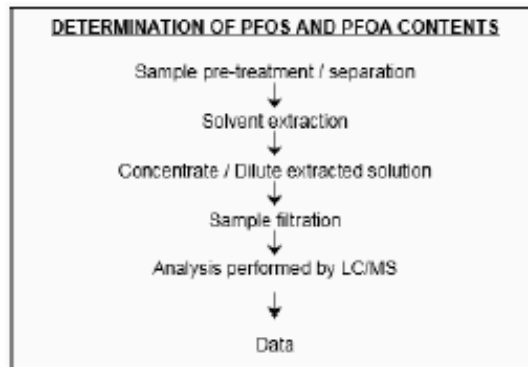

SIGNED FOR AND ON BEHALF OF
SGS (MALAYSIA) SDN BHD

TAY SIAM PINE
TECHNICAL MANAGER
IKM No. M/3452/6047/11/12



Test Report Form No.: 868/170CR6013, Ver.: 4.0, Effective Date: 13/01/2019

*** End of test report ***

Page 15 of 15

This document is issued by the Company subject to its General Conditions of Service printed overleaf, available on request or accessible at <https://www.sgs.com/en/terms-and-conditions> and, for electronic format documents, subject to Terms and Conditions for Electronic Documents at <https://www.sgs.com/en/terms-and-conditions/sgs-malaysia-sdn-bhd>. Attention is drawn to the limitation of liability, indemnification and jurisdiction issues defined therein. Any holder of this document is advised that information contained hereon reflects the Company's findings at the time of its intervention only and within the limits of Client's instructions. If any, the Company's sole responsibility is to its Client and this document does not exonerate parties to a transaction from exercising all their rights and obligations under the transaction documents. This document cannot be reproduced except in full, without prior written approval of the Company. Any unauthorized alteration, forgery or falsification of the content or appearance of this document is unlawful and offenders may be prosecuted to the fullest extent of the law. Unless otherwise stated the results shown in this test report refer only to the sample(s) tested and such sample(s) are retained for 14 days (for perishable samples) or 90 days only.