

ULTRAFAST RECOVERY RECTIFIERS

VOLTAGE	100 to 600 Volts
CURRENT	20 Amperes

FEATURES

- Plastic package has Underwriters Laboratory Flammability Classification 94V-0. Flame Retardant Epoxy Molding Compound.
- Low power loss, high efficiency.
- Low forward voltage, high current capability.
- High surge capability
- Ultra fast recovery time, high voltage.
- Lead free in comply with EU RoHS.

MECHANICAL DATA

- Case: TO-220AB molded plastic
- Terminals: solder plated, solderable per MIL-STD-750, Method 2026
- Polarity: As marked.
- Mounting Position: Any

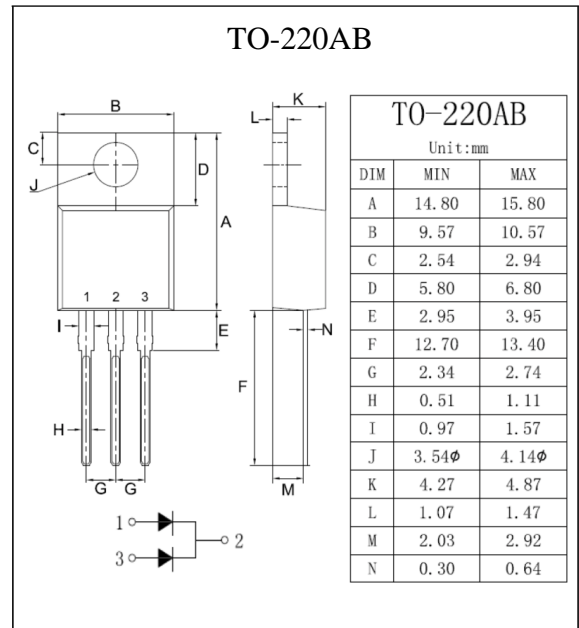

MAXIMUM RATINGS AND ELECTRICAL CHARACTERISTICS

Ratings at 25°C ambient temperature unless otherwise specified. Single phase, half wave, 60 Hz, resistive or inductive load.

For capacitive load, derate current by 20%

PARAMETER	SYMBOL	SF2010CT	SF2020CT	SF2030CT	SF2040CT	SF2050CT	SF2060CT	UNITS
Maximum Recurrent Peak Reverse Voltage	V_{RRM}	100	200	300	400	500	600	V
Maximum RMS Voltage	V_{RMS}	70	140	210	280	350	420	V
Maximum DC Blocking Voltage	V_{DC}	100	200	300	400	500	600	V
Maximum Average Forward Current at $T_c = 100^\circ\text{C}$	$I_{F(AV)}$	20						A
Peak Forward Surge Current : 8.3ms single half sine-wave superimposed on rated load (JEDEC method)	I_{FSM}	110						A
Maximum Forward Voltage at 10A	V_F	1	1.3		1.7			V
Maximum DC Reverse Current at Rated DC Blocking Voltage $T_j=25^\circ\text{C}$ $T_j=125^\circ\text{C}$	I_R	10				500		μA
Typical Junction Capacitance (Note 1)	C_j	200						pF
Maximum Reverse Recovery Time (Note 2)	t_{rr}	35						ns
Typical Thermal Resistance (Note 3)	$R_{\theta JC}$	3						$^\circ\text{C} / \text{W}$
Operating Junction and Storage Temperature Range	T_j, T_{STG}	-55 to +150						$^\circ\text{C}$

NOTES:

1. Measured at 1 MHz and applied reverse voltage of 4.0 VDC.
2. Reverse Recovery Test Conditions: $I_F=0.5\text{A}$, $I_R=1\text{A}$, $I_{rr}=0.25\text{A}$.
3. Thermal resistance from Junction to case.

RATING AND CHARACTERISTIC CURVES

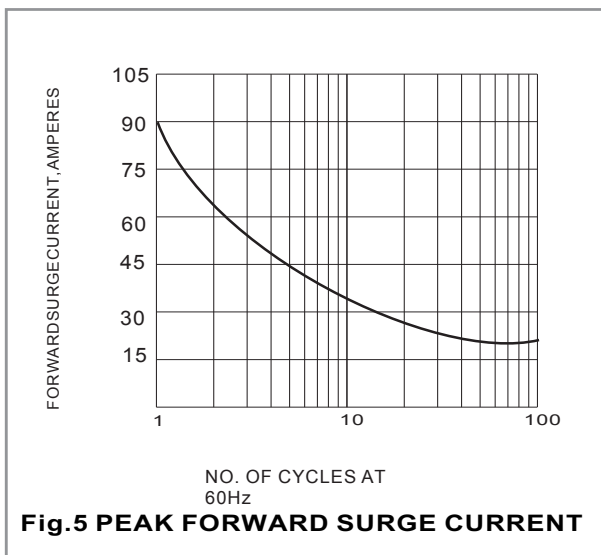
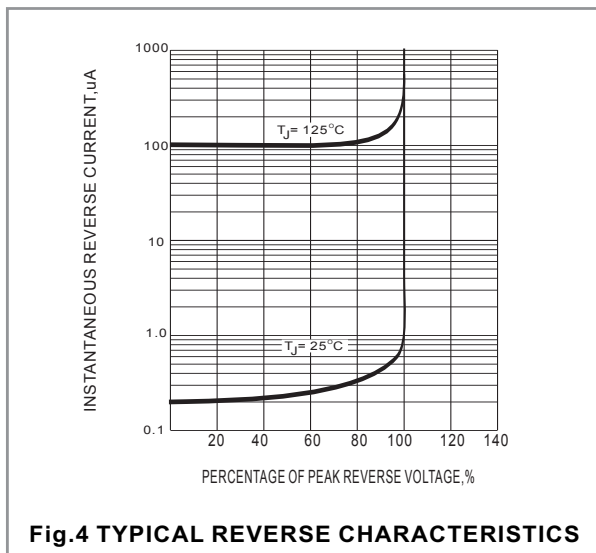
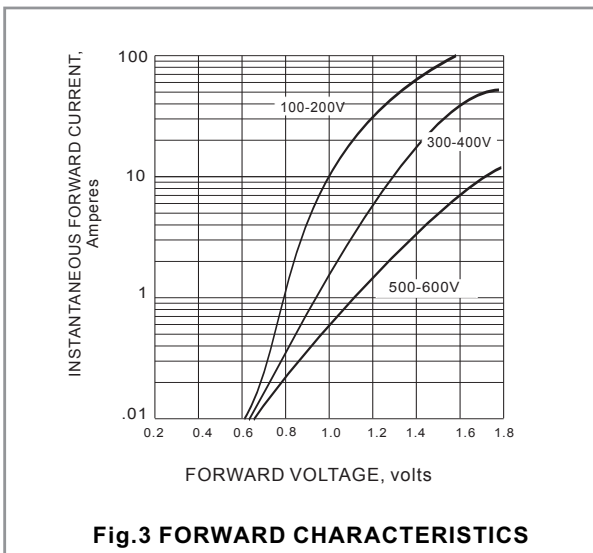
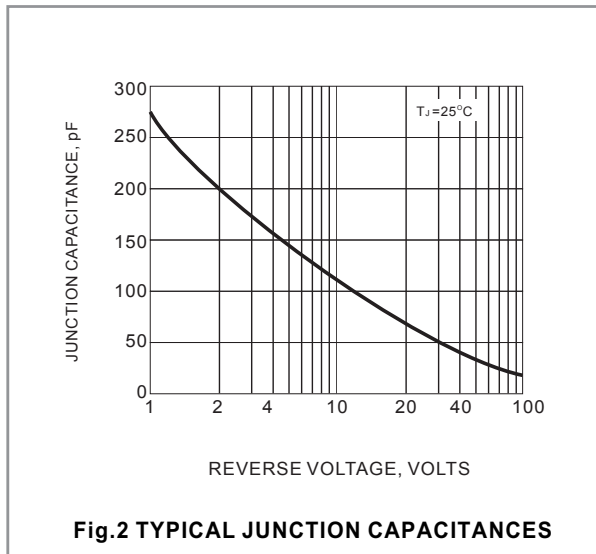
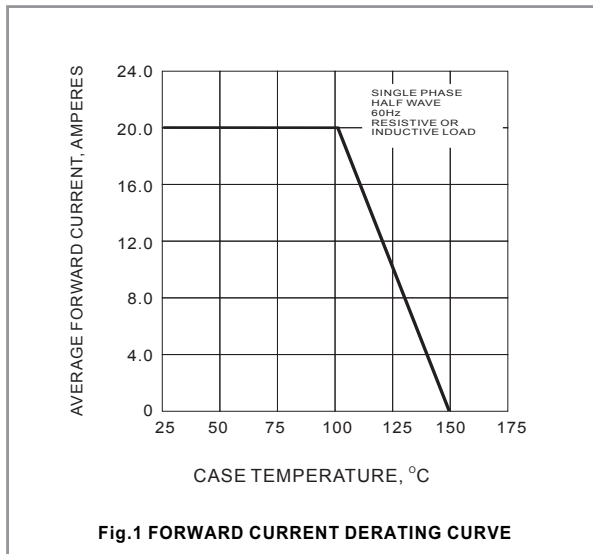

Important Notice and Disclaimer

- Reproducing and modifying information of the document is prohibited without permission from DIYI.
- DIYI reserves the right to make changes to this document and its products and specifications at any time without notice. Customers should obtain and confirm the latest product information and specifications before final design, purchase or use.
- DIYI disclaims any and all liability arising out of the application or use of any product including damages incidentally and consequentially occurred.
- DIYI does not assume any and all implied warranties, including warranties of fitness for particular purpose, non-infringement and merchantability.
- Applications shown on the herein document are examples of standard use and operation. Customers are responsible in comprehending the suitable use in particular applications.
DIYI makes no representation or warranty that such applications will be suitable for the specified use without further testing or modification.
- The products shown herein are not designed and authorized for equipments requiring high level of reliability or relating to human life and for any applications concerning life-saving or life-sustaining, such as medical instruments, transportation equipment, aerospace machinery et cetera. Customers using or selling these products for use in such applications do so at their own risk and agree to fully indemnify DIYI for any damages resulting from such improper use or sale.
- Since DIYI uses lot number as the tracking base, please provide the lot number for tracking when complaining.