



MD7602 Series is a high voltage (up to 40V) low power low dropout voltage regulator (LDO) manufactured in CMOS processes. It can deliver up to 1A of current while consuming only 1.6uA of quiescent current. It consists of a reference voltage generator, an error amplifier, a current foldback circuit, and a phase compensation circuit plus a driver transistor.

FEATURES

- Ultra-low Quiescent Current: 1.6uA
- Maximum Input Voltage: 40V
- Output Voltage Highly Accurate: $\pm 2\%$
- Maximum Output Current: 1A
- Dropout Voltage: 10mV@ $I_{OUT}=10mA$
- Temperature Stability: $\pm 50ppm/^{\circ}C$
- ON/OFF Logic = Enable High
- Protections Circuits: Current Limiter, Foldback, Thermal shutdown
- Output Capacitor: Low ESR Ceramic Capacitor Compatible

APPLICATIONS

- Smart wearer
- Long-life battery-powered devices
- Portable mobile devices, such as mobile phones, cameras, and so on
- Wireless communication equipment

Product Selections

Type	Output Voltage (note 1*)	Current Limit	Accuracy	Package (note 2*)	MARKING (note 3*)
MD7602A30	3.0V	1.8A	$\pm 2\%$	SOT-89-3	7602A30
MD7602A33	3.3V	1.8A	$\pm 2\%$	SOT-89-3	7602A33
MD7602A36	3.6V	1.8A	$\pm 2\%$	SOT-89-3	7602A36
MD7602A38	3.8V	1.8A	$\pm 2\%$	SOT-89-3	7602A38
MD7602A40	4.0V	1.8A	$\pm 2\%$	SOT-89-3	7602A40
MD7602A50	5.0V	1.8A	$\pm 2\%$	SOT-89-3	7602A50
MD7602A10	10.0V	1.8A	$\pm 2\%$	SOT-89-3	7602A10
MD7602A12	12.5V	1.8A	$\pm 2\%$	SOT-89-3	7602A12
MD7602C30	3.0V	1.8A	$\pm 2\%$	SOT-223	7602C30
MD7602C33	3.3V	1.8A	$\pm 2\%$	SOT-223	7602C33
MD7602C36	3.6V	1.8A	$\pm 2\%$	SOT-223	7602C36
MD7602C40	4.0V	1.8A	$\pm 2\%$	SOT-223	7602C40
MD7602C50	5.0V	1.8A	$\pm 2\%$	SOT-223	7602C50
MD7602C12	12.0V	1.8A	$\pm 2\%$	SOT-223	7602C12
MD7602R30	3.0V	1.8A	$\pm 2\%$	SOT-89-5	7602R30
MD7602R33	3.3V	1.8A	$\pm 2\%$	SOT-89-5	7602R33

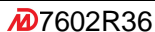
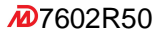
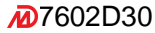
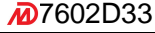
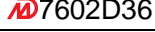
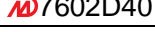
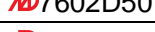
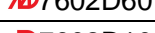
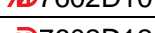
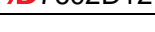
MD7602R36	3.6V	1.8A	±2%	SOT-89-5	
MD7602R50	5.0V	1.8A	±2%	SOT-89-5	
MD7602D30	3.0V	1.8A	±2%	TO-252	
MD7602D33	3.3V	1.8A	±2%	TO-252	
MD7602D36	3.6V	1.8A	±2%	TO-252	
MD7602D40	4.0V	1.8A	±2%	TO-252	
MD7602D50	5.0V	1.8A	±2%	TO-252	
MD7602D60	6.0V	1.8A	±2%	TO-252	
MD7602D10	10.0V	1.8A	±2%	TO-252	
MD7602D12	12.0V	1.8A	±2%	TO-252	

Notes:

1* Customer can request to customize the output voltage ranged from 1.2V to 15V if desired voltage is not found in the selections.

2* Customer can request customization of package choice.

3* Please pay attention to the MARKING of the product package type.

■ PIN CONFIGURATION (TOP VIEW)

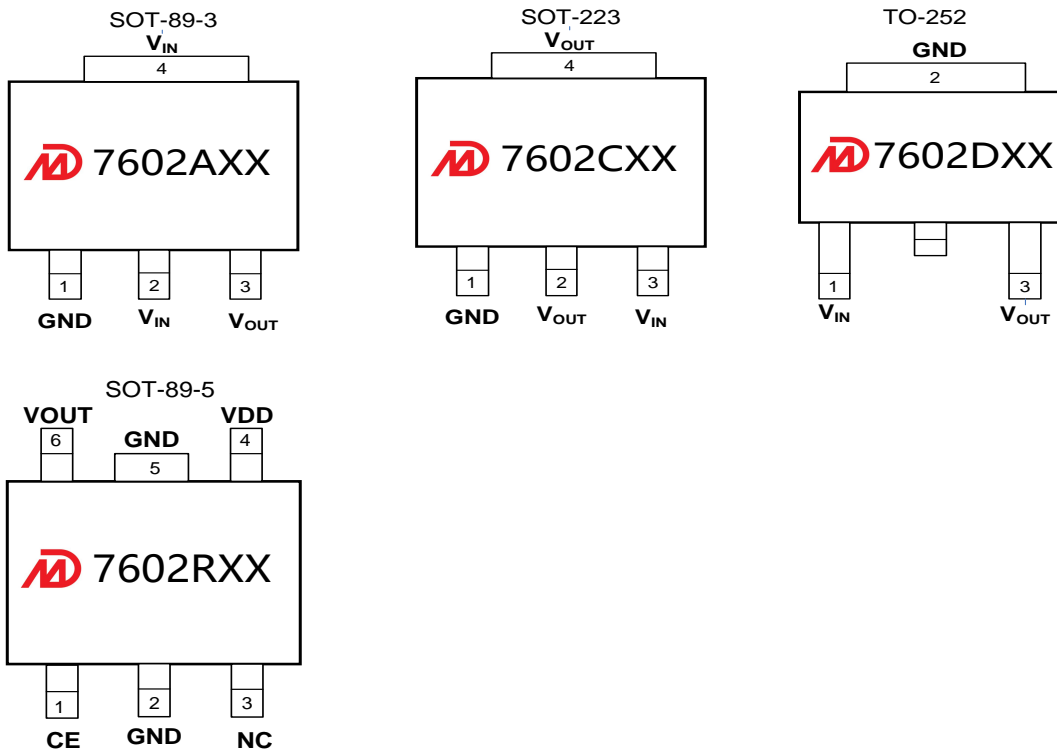

■ Absolute Maximum Ratings (Unless otherwise indicated: $T_a=25^{\circ}\text{C}$)

PARAMETER	SYMBOL	RATINGS	UNITS
Input Voltage	V_{IN}	-0.3 ~ 45	V
Output Voltage	V_{OUT}	$V_{SS}-0.3 \sim V_{IN}+0.3V$	
Power Dissipation	P_D	SOT 89	1000
		TO 252	1800
		SOT 223	1500
Operating Ambient Temperature	T_{opr}	-40 ~ +85	°C
Storage Temperature	T_{stg}	-40 ~ +125	
ESD Protection	ESD HBM	2000	V

Note: Stresses above those listed under "Absolute Maximum Ratings" may cause permanent damage to the device.

■ ELECTRICAL CHARACTERISTICS

MD7602 Series (Unless otherwise indicated: $T_a=25^{\circ}\text{C}$)

PARAMETER	SYMBOL	CONDITIONS	MIN.	TYP.	MAX.	UNIT	
Output Voltage*1	$V_{OUT(S)}$	$V_{IN}=V_{OUT(S)}+2V, I_{OUT}=10\text{mA}$	$V_{OUT(S)}\times 0.98$	$V_{OUT(S)}$	$V_{OUT(S)}\times 1.02$	V	
Dropout Voltage*2	V_{DROP}	$I_{OUT}=1\text{mA}$		4	8	mV	
		$I_{OUT}=1\text{A}$		1000	1500		
Line Regulation	$\frac{\Delta V_{OUT}}{\Delta V_{IN} \cdot V_{OUT(S)}}$	$V_{OUT(S)}+2V \leq V_{IN} \leq 40V$ $I_{OUT}=1\text{mA}$		0.01	0.02	%/V	
Load Regulation	ΔV_{OUT2}	$V_{IN}=V_{OUT(S)}+2V$ $1\text{mA} \leq I_{OUT} \leq 300\text{mA}$	$V_{OUT(S)} \leq 10V$		20	80	mV
			$V_{OUT(S)} > 10V$		85	150	
Temperature Stability	$\frac{\Delta V_{OUT}}{\Delta T_a \cdot V_{OUT(S)}}$	$V_{IN}=V_{OUT(S)}+2V, I_{OUT}=10\text{mA}$ $-40^{\circ}\text{C} \leq T_a \leq 85^{\circ}\text{C}$		± 50		ppm/ $^{\circ}\text{C}$	
GND Current (CE=VIN)	I_{GND}	no load	$V_{OUT(S)} < 3.0V$	0.8	1.2	2	uA
			$3.0 \leq V_{OUT(S)} \leq 5.3V$	1	1.6	2	
			$V_{OUT(S)} > 5.3V$	1.5	2.3	3	
		$I_{OUT}=100\text{mA}$		460			
Shutdown Current (CE=0)	I_{SHUT}	$V_{IN}=40.0V, V_{CE}=0$		0.01	0.1	uA	
Input Voltage	V_{IN}	---	2.2		40	V	
Maximum Output Current	I_{OUTMAX}		1			A	
Current Limit*3	I_{LIM}	$V_{IN}=V_{OUT(S)}+2V,$ $V_{OUT}=0.95 \times V_{OUT(S)}$		1.8			
Short Circuit Current*4	I_{SHORT}	$V_{IN}=V_{OUT(S)}+2V, V_{OUT}=0V$		95		mA	
Power Supply Rejection Ratio	PSRR	$f=10\text{Hz}, V_{OUT(S)}=3.6V$		73.2		dB	
		$f=100\text{Hz}, V_{OUT(S)}=3.6V$		72.2			
		$f=1\text{kHz}, V_{OUT(S)}=3.6V$		54.5			
CE 'H' Level Voltage	V_{CEH}		1.5		40.0	V	
CE 'L' Level Voltage	V_{CEL}		0		0.6		
CE 'H' Level Current	I_{CEH}	$V_{IN}=40V, V_{CE}=V_{IN}$	-0.1		0.1	uA	
CE 'L' Level Voltage	I_{CEL}	$V_{IN}=40V, V_{CE}=0$	-0.1		0.1		
Over Temperature Protection	OTP	$I_{OUT}=10\text{mA}$		145		$^{\circ}\text{C}$	

Notes:

1. $V_{OUT(S)}$: Output voltage when $V_{IN}=V_{OUT}+2V, I_{OUT}=1\text{mA}$.
2. $V_{DROP}=V_{IN1} - (V_{OUT(S)} \times 0.98)$ where V_{IN1} is the input voltage when $V_{OUT} = V_{OUT(S)} \times 0.98$.
3. I_{LIM} : Output current when $V_{IN}=V_{OUT(S)}+2V$ and $V_{OUT} = 0.95 \times V_{OUT(S)}$.
4. V_{OUT} pin should be shorted to GND pin, and the impedance between them is less than 0.1 ohm.

■ TYPICAL APPLICATIONS

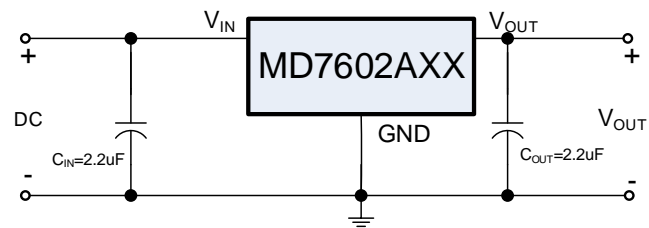

■ Notes on Use

- Input Capacitor (C_{IN}): 2.2 μ F above
- Output Capacitor (C_{OUT}): 2.2 μ F above

■ TYPICAL PERFORMANCE CHARACTERISTICS(CONTINUED)

Test Conditions: $V_{IN}=V_{OUT}+2.0V$, $C_{IN}=2.2\mu F$, $C_{OUT}=2.2\mu F$, unless otherwise indicated.

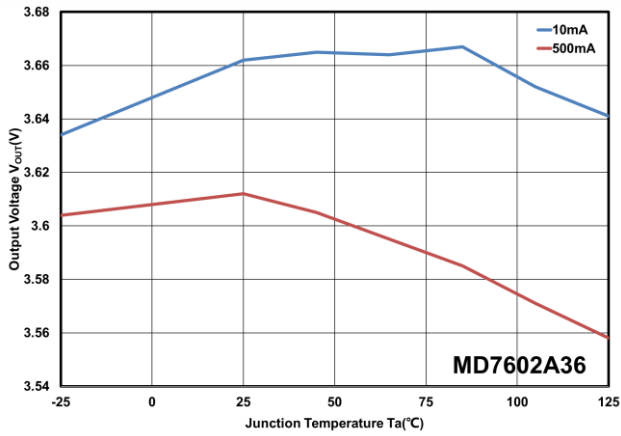

V_{OUT} vs Temperature at $V_{OUT}=3.6V$

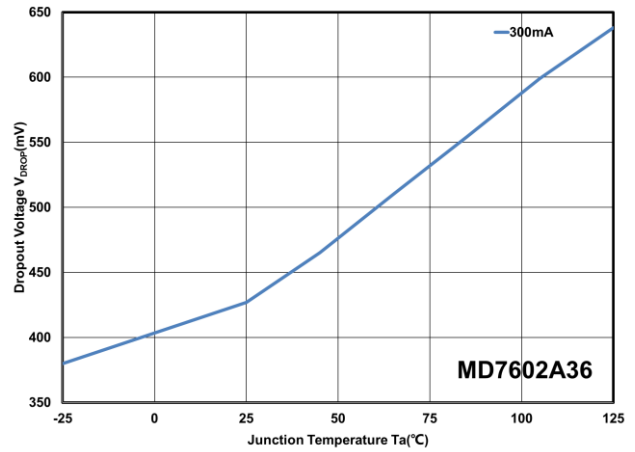

V_{DROP} vs Temperature at $V_{OUT}=3.6V$

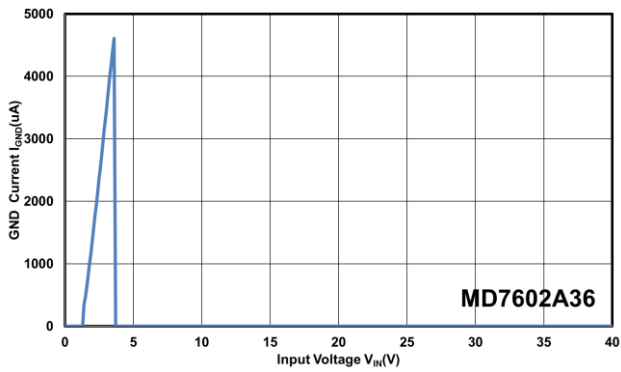

GND Current vs Input Voltage at $V_{OUT}=3.6V$

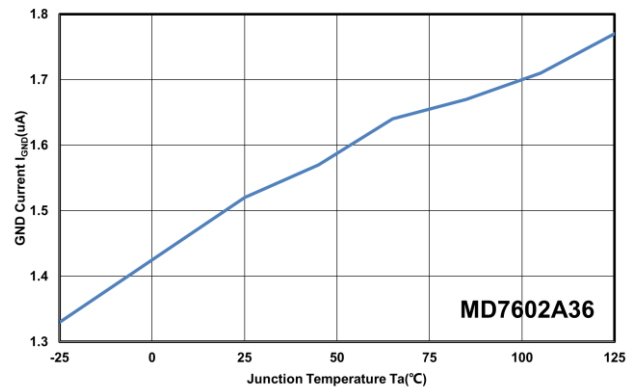

GND Current vs Temperature at $V_{OUT}=3.6V$

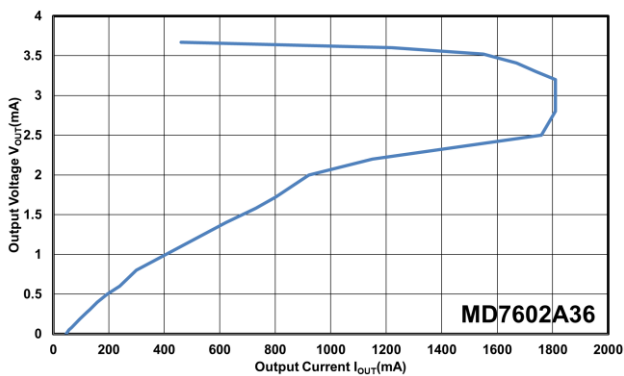

Output Current Fold-back at $V_{OUT}=3.6V$

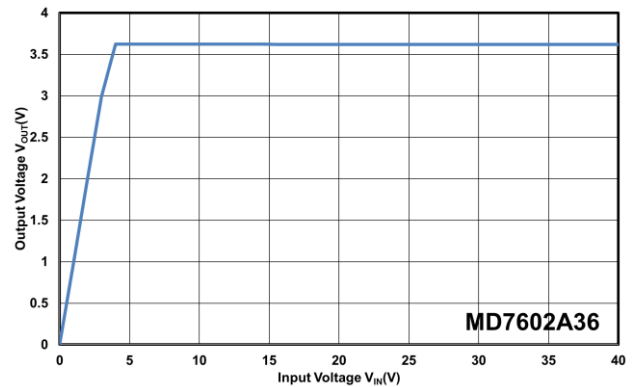

Output Voltage vs Input Voltage at $V_{OUT}=3.6V$

■ TYPICAL PERFORMANCE CHARACTERISTICS(CONTINUED)

Test Conditions: $V_{IN}=V_{OUT}+2.0V$, $C_{IN}=2.2\mu F$, $C_{OUT}=2.2\mu F$, unless otherwise indicated.

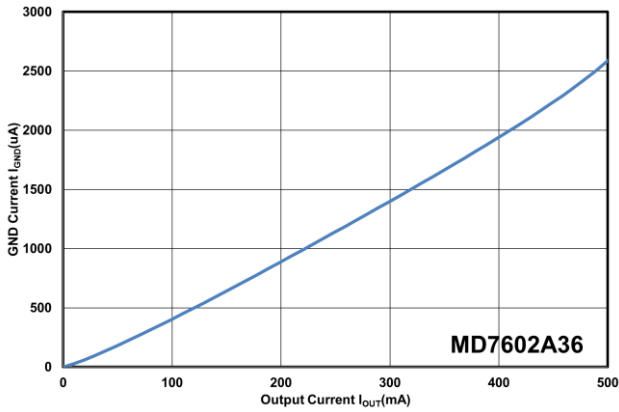

GND Current vs Output Current at $V_{OUT}=3.6V$

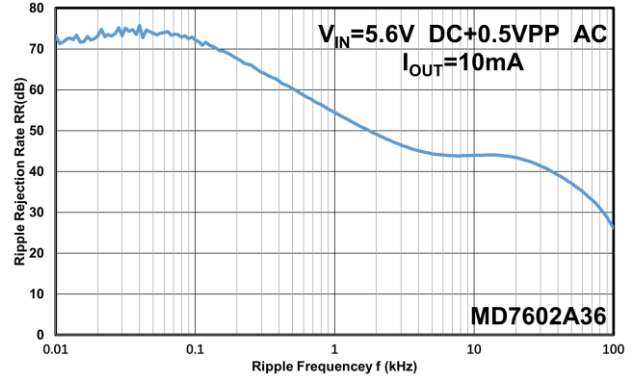

Power Supply Rejection Ratio at $V_{OUT}=3.6V$

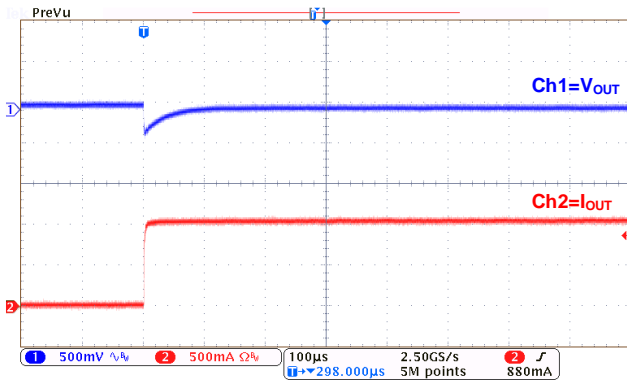

Load Transient at $V_{OUT}=3.6V$
7602A36($I_{OUT}=0mA\sim 1A$)

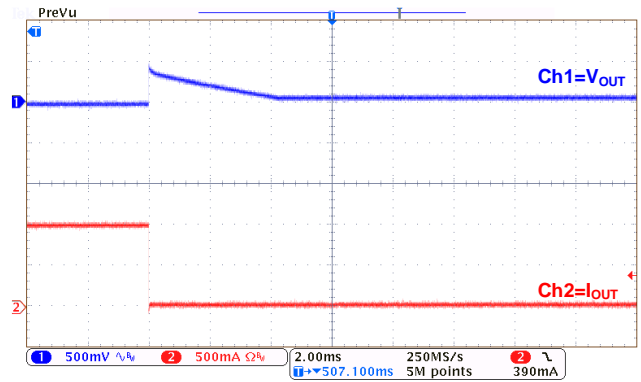

Load Transient at $V_{OUT}=3.6V$
7602A36($I_{OUT}=1A\sim 0mA$)

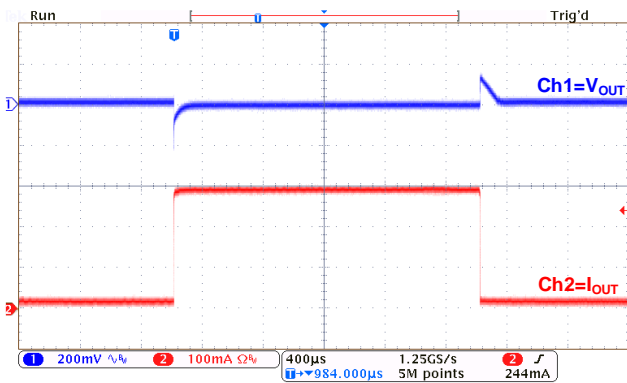

Load Transient at $V_{OUT}=3.6V$
7602A36($I_{OUT}=1mA\sim 300mA\sim 1mA$)

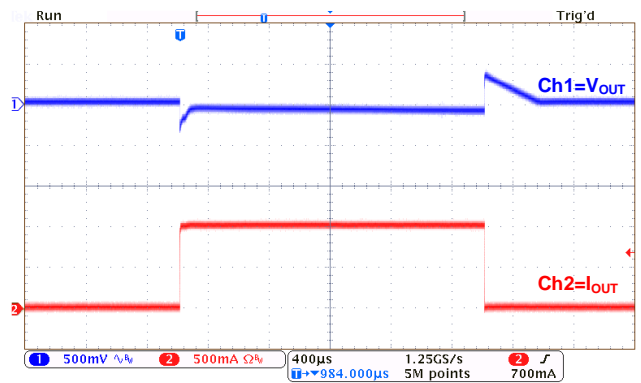

Load Transient at $V_{OUT}=3.6V$
7602A36($I_{OUT}=1mA\sim 1A\sim 1mA$)

■ TYPICAL PERFORMANCE CHARACTERISTICS(CONTINUED)

Test Conditions: $V_{IN}=V_{OUT}+2.0V$, $C_{IN}=2.2\mu F$, $C_{OUT}=2.2\mu F$, unless otherwise indicated.

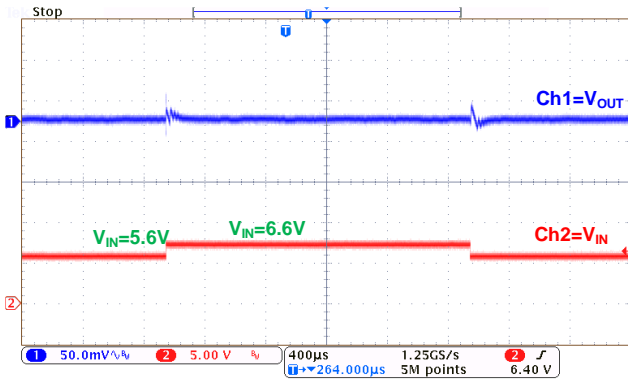

Line Transient at $V_{OUT}=3.6V$
7602A36($I_{OUT}=1mA$)

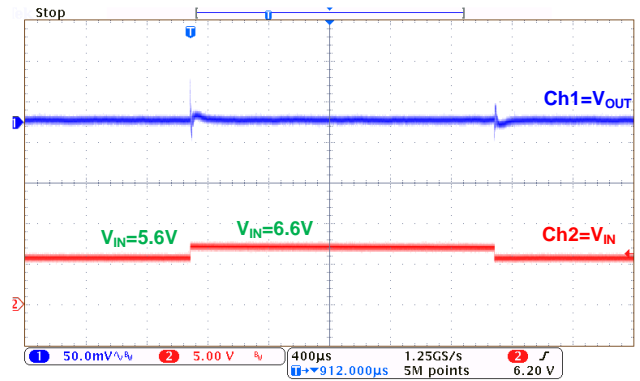

Line Transient at $V_{OUT}=3.6V$
7602A36($I_{OUT}=10mA$)

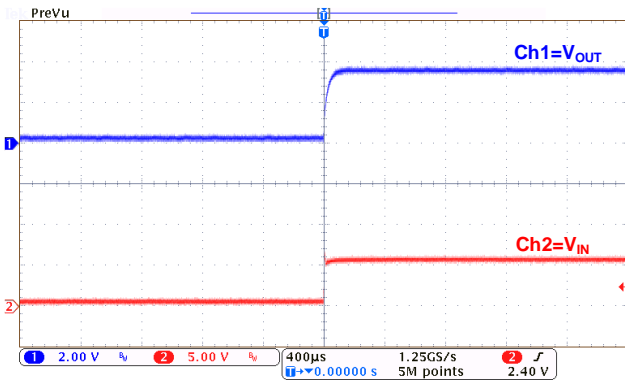

Power-Up at $V_{OUT}=3.6V$
7602A36($I_{OUT}=0mA$)

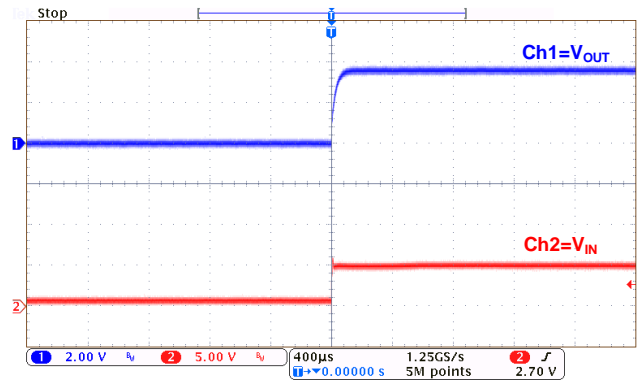

Power-Up at $V_{OUT}=3.6V$
7602A36($I_{OUT}=1A$)

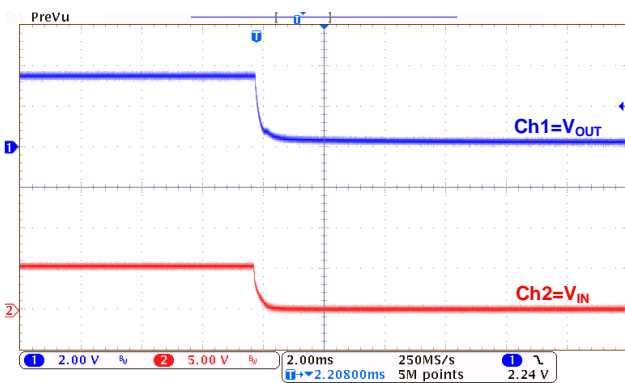

Power- Down at $V_{OUT}=3.6V$
7602A36($I_{OUT}=0mA$)

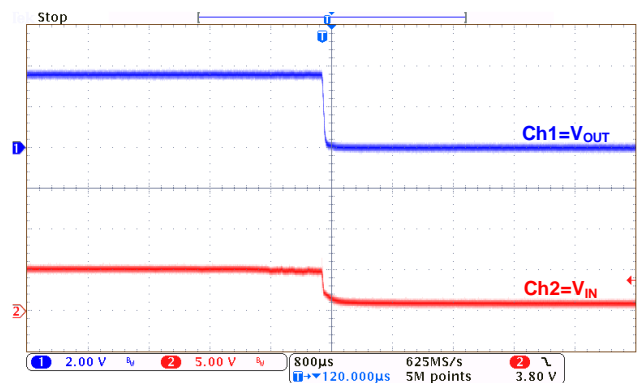

Power- Down at $V_{OUT}=3.6V$
7602A36($I_{OUT}=1A$)

■ OPERATIONAL EXPLANATION

1. Output voltage control

The voltage divided by resistors R1 and R2 is compared with the internal reference voltage by the error amplifier. The amplifier output then drives the P-channel MOSFET connected to the V_{OUT} pin. The output voltage at the V_{OUT} pin is regulated by this negative feedback system. The current limit circuit and short protect circuit operate in relation to output current level.

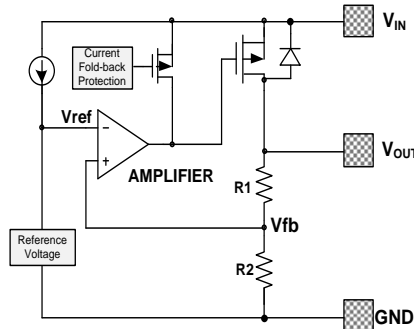

2. Pass transistor

The pass transistor with low turn-on resistance used in MD7602 is a P-channel MOSFET. If the potential on V_{OUT} pin is higher than V_{IN} , it is possible that IC will be destroyed due to reverse current which is caused by parasitic diodes between V_{IN} and V_{OUT} . Therefore, the V_{OUT} pin potential exceeds $V_{IN}+0.3V$ is not allowed.

3. Current foldback and over temperature protection

The MD7602 series includes a combination of a fixed current limiter circuit and a foldback circuit, which aid the operations of the current limiter and circuit protection. When the load current reaches the current limit level, the fixed current limiter circuit operates and output voltage drops. As a result of this drop in output voltage, the foldback circuit operates, output voltage drops further and output current decreases. This design can prevent the chip be damaged due to over temperature, moreover, the heat dissipation is limited by the package type.

Special attention should be paid to that the product of the dropout voltage on the chip and the output current must be smaller than the heat dissipation. If power consumption on the chip is more than the heat dissipation, OTP will protect the chip from damaging due to over temperature.

■ Notes:

1. The input and output capacitors should be placed as close as possible to the IC.
2. If the impedance of the power supply is high, which is caused by forgetting installing input capacitor or installing too small value capacitor, the oscillation may occur.
3. Pay attention to the operation conditions of input and output voltage and load current, such that the power consumption in the IC should not exceed the allowable power consumption of the package even though the chip has short circuit protection.
4. IC has a built-in anti-static protection (ESD) circuit, but please do not add excessive stress to the IC.

■ PACKAGING INFORMATION

TO-252-2L PACKAGE OUTLINE DIMENSIONS

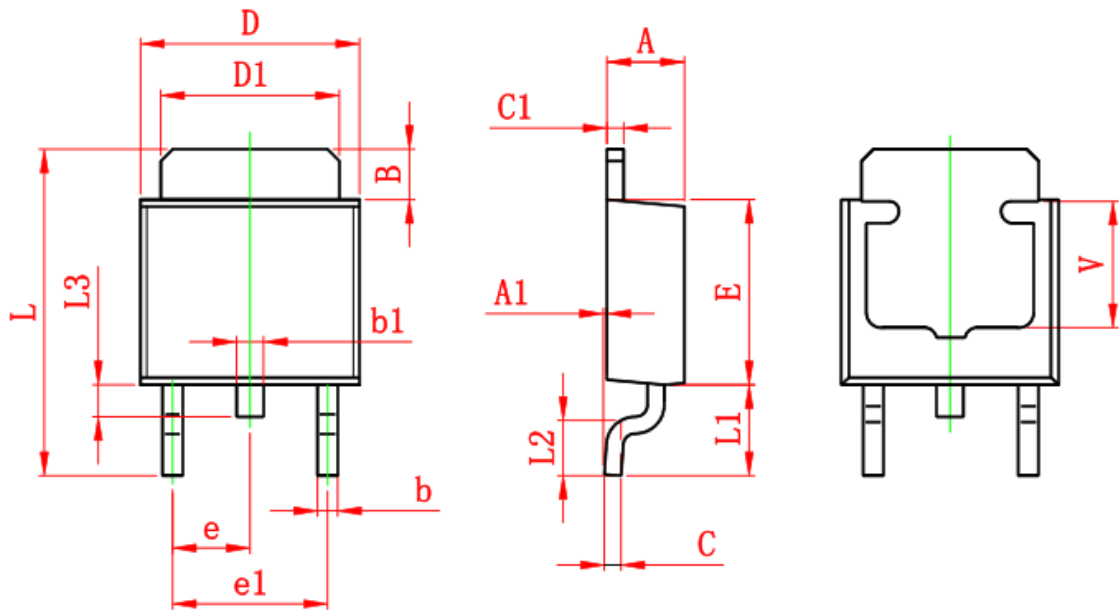

Symbol	Dimensions In Millimeters		Dimensions In Inches	
	Min.	Max.	Min.	Max.
A	2.200	2.400	0.087	0.094
A1	0.000	0.127	0.000	0.005
B	1.350	1.650	0.053	0.065
b	0.500	0.700	0.020	0.028
b1	0.700	0.900	0.028	0.035
c	0.430	0.580	0.017	0.023
c1	0.430	0.580	0.017	0.023
D	6.350	6.650	0.250	0.262
D1	5.200	5.400	0.205	0.213
E	5.400	5.700	0.213	0.224
e	2.300 TYP.		0.091 TYP.	
e1	4.500	4.700	0.177	0.185
L	9.500	9.900	0.374	0.390
L1	2.550	2.900	0.100	0.114
L2	1.400	1.780	0.055	0.070
L3	0.600	0.900	0.024	0.035
V	3.800 REF.		0.150 REF.	

■ PACKAGING INFORMATION(Continued)

SOT-223 PACKAGE OUTLINE DIMENSIONS

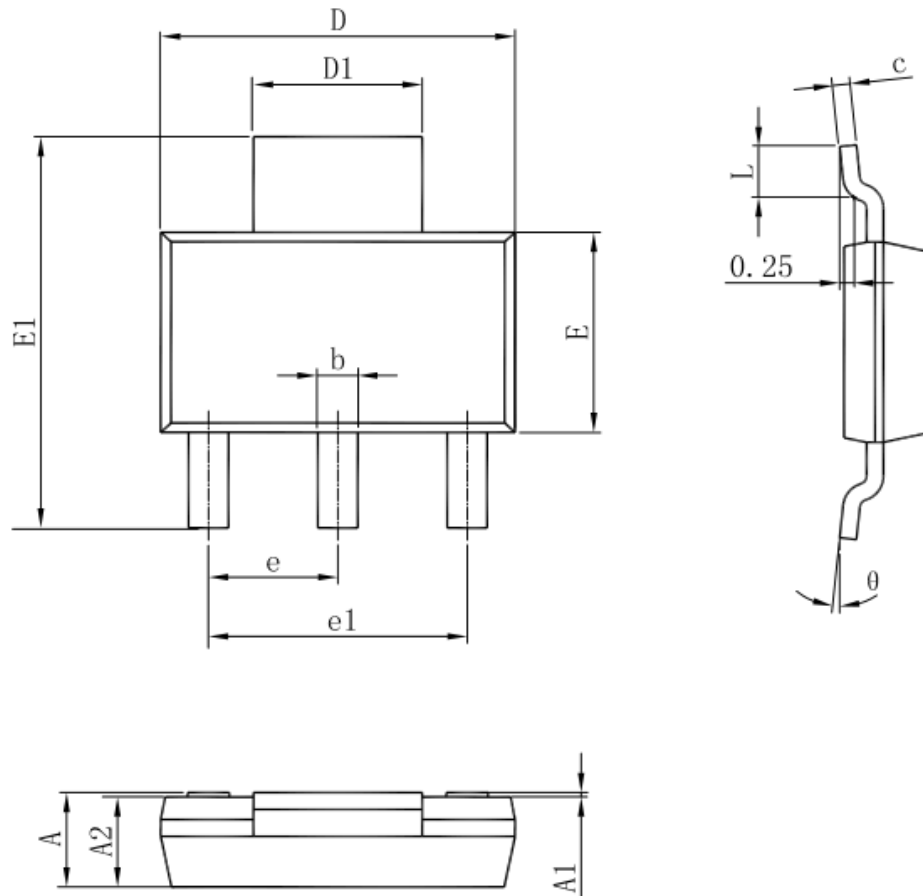

Symbol	Dimensions In Millimeters		Dimensions In Inches	
	Min	Max	Min	Max
A	1.520	1.800	0.060	0.071
A1	0.000	0.100	0.000	0.004
A2	1.500	1.700	0.059	0.067
b	0.660	0.820	0.026	0.032
c	0.250	0.350	0.010	0.014
D	6.200	6.400	0.244	0.252
D1	2.900	3.100	0.114	0.122
E	3.300	3.700	0.130	0.146
E1	6.830	7.070	0.269	0.278
e	2.300(BSC)		0.091(BSC)	
e1	4.500	4.700	0.177	0.185
L	0.900	1.150	0.035	0.045
θ	0°	10°	0°	10°

■ PACKAGING INFORMATION(Continued)

SOT-89-3L PACKAGE OUTLINE DIMENSIONS

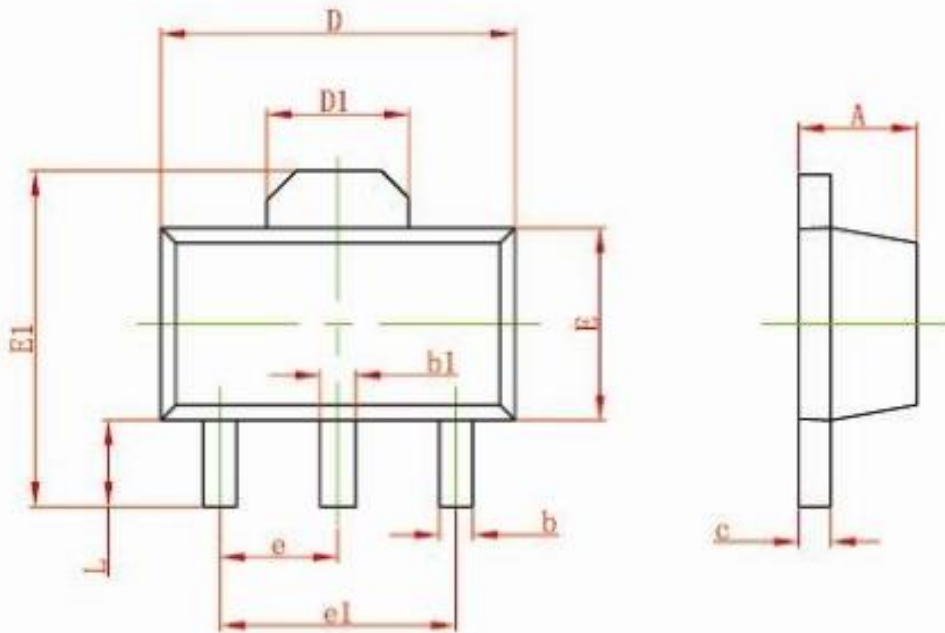

Symbol	Dimensions in Millimeters		Dimensions in Inches	
	Min	Max	Min	Max
A	1.400	1.600	0.055	0.063
b	0.320	0.520	0.013	0.197
b1	0.400	0.580	0.016	0.023
c	0.350	0.440	0.014	0.017
D	4.400	4.600	0.173	0.181
D1	1.550 REF		0.061 REF	
E	2.300	2.600	0.091	0.102
E1	3.940	4.250	0.155	0.167
e	1.500 TYP		0.060 TYP	
e1	3.000 TYP		0.118 TYP	
L	0.900	1.200	0.035	0.047

■ PACKAGING INFORMATION(Continued)

SOT-89-5L PACKAGE OUTLINE DIMENSIONS

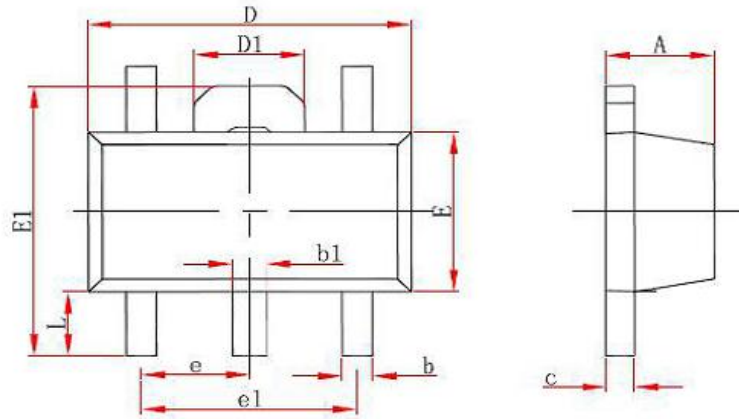

Symbol	Dimensions in Millimeters		Dimensions in Inches	
	Min.	Max.	Min.	Max.
A	1.400	1.600	0.055	0.063
b	0.320	0.520	0.013	0.020
b1	0.380	0.580	0.015	0.023
c	0.350	0.440	0.014	0.017
D	4.400	4.600	0.173	0.181
D1	1.550 REF.		0.061 REF.	
E	2.300	2.600	0.091	0.102
E1	3.940	4.250	0.155	0.167
e	1.500 TYP.		0.060 TYP.	
e1	3.000 TYP.		0.118 TYP.	
L	0.900	1.200	0.035	0.047

For the newest datasheet, please see the website:

www.md-ic.com.cn

Version V1.6 20220906