

N-沟道功率 MOS 管/ N-CHANNEL POWER MOSFET

SIF2N65FB

- 特点：导通电阻低 开关速度快 输入阻抗高 符合RoHS规范
- FEATURES: ■LOW ON-RESISTANCE ■FAST SWITCHING ■HIGH INPUT RESISTANCE ■RoHS COMPLIANT
- 应用：电子镇流器 电子变压器 开关电源
- APPLICATION: ■ELECTRONIC BALLAST ■ELECTRONIC TRANSFORMER ■SWITCH MODE POWER SUPPLY

●最大额定值 (Tc=25°C)

●Absolute Maximum Ratings (Tc=25°C)

TO-220/220FP

参数 PARAMETER	符号 SYMBOL	额定值 VALUE	单位 UNIT
漏-源电压 Drain-source Voltage	V _{DS}	650	V
栅-源电压 gate-source Voltage	V _{GS}	±30	V
漏极电流 Continuous Drain Current TC=25°C	I _D	2.0	A
漏极电流 Continuous Drain Current TC=100°C	I _D	1.25	A
最大脉冲电流 Drain Current – Pulsed ①	I _{DM}	8	A
耗散功率 Power Dissipation	P _{tot}	TO-220:54	W
		TO-220FP:23	
最高结温 Junction Temperature	T _j	150	°C
存储温度 Storage Temperature	T _{STG}	-55-150	°C
单脉冲雪崩能量 Single Pulse Avalanche Energy②	E _{AS}	72	mJ

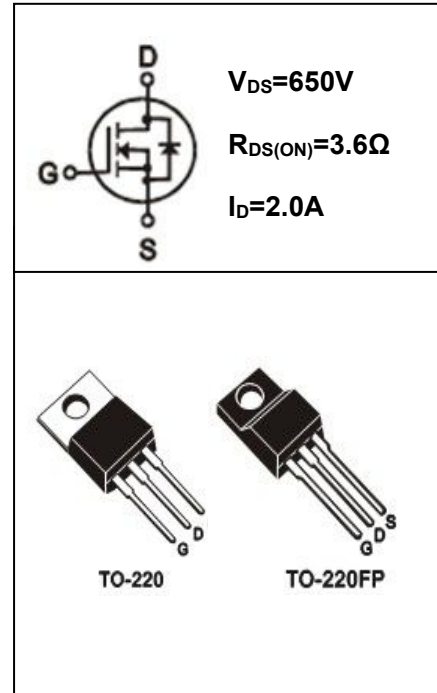

●电特性 (Tc=25°C)

●Electronic Characteristics (Tc=25°C)

参数 PARAMETER	符号 SYMBOL	测试条件 TEST CONDITION	最小值 MIN	典型值 TYP	最大值 MAX	单位 UNIT
漏-源击穿电压 Drain-source Breakdown Voltage	BV _{DSS}	V _{GS} =0V, I _D =250μA	650			V
击穿电压温度系数 Breakdown Voltage Temperature Coefficient	ΔBV _{DSS} /ΔT _j	I _D =250uA, Referenced to 25°C		0.6		V/°C
栅极开启电压 Gate Threshold Voltage	V _{GS(TH)}	V _{GS} =V _{DS} , I _D =250μA	2.0		4.0	V
漏-源漏电流 Drain-source Leakage Current	I _{DSS}	V _{DS} =650V, V _{GS} =0V, T _j =25°C			1	μA
		V _{DS} =520V, V _{GS} =0V, T _j =125°C			100	μA
跨导 Forward Transconductance	g _{fs}	V _{DS} =15V, I _D =1A ③		2.5		S

●订单信息/ORDERING INFORMATION:

包装形式/PACKING	订货编码/ORDERING CODE	
	普通塑封料/ Normal Package Material	无卤塑封料/Halogen Free
TO-220 条管装/TUBE PACKING	SIF2N65FB TO-220-TU	SIF2N65FB TO-220-TU-HF
TO-220FP 条管装/TUBE PACKING	SIF2N65FB TO-220FP-TU	SIF2N65FB TO-220FP-TU-HF

N-沟道功率MOS管/ N-CHANNEL POWER MOSFET

SIF2N65FB

参数 PARAMETER	符号 SYMBOL	测试条件 TEST CONDITION	最小值 MIN	典型值 TYP	最大值 MAX	单位 UNIT
栅极漏电流 Gate-body Leakage Current ($V_{DS} = 0$)	I_{GSS}	$V_{GS} = \pm 30V$			± 100	nA
漏-源导通电阻 Static Drain-source On Resistance	$R_{DS(ON)}$	$V_{GS} = 10V, I_D = 1.0A$ ③		3.6	4.2	Ω
输入电容 Input Capacitance	C_{iss}	$V_{GS} = 0V, V_{DS} = 25V$ $F = 1.0MHz$		278		pF
输出电容 Output Capacitance	C_{oss}			30		
反向传输电容 Reverse transfer Capacitance	C_{rss}			5		
关断延迟 Turn -Off Delay Time	$T_d(off)$	$V_{DD} = 325V, I_D = 2.0A$ $R_G = 25\Omega$ ③		29		ns
栅极电荷 Total Gate Charge	Q_g	$I_D = 2.0A, V_{DS} = 520V$ $V_{GS} = 10V$ ③		7.4		nC
栅源电荷 Gate-to-Source Charge	Q_{gs}			1.4		nC
栅漏电荷 Gate-to-Drain Charge	Q_{gd}			2.2		nC
二极管正向电流 Continuous Diode Forward Current	I_S				2.0	A
二极管正向压降 Diode Forward Voltage	V_{SD}	$T_j = 25^\circ C, I_S = 2.0A$ $V_{GS} = 0V$ ③			1.4	V
反向恢复时间 Reverse Recovery Time	t_{rr}	$T_j = 25^\circ C, I_f = 2.0A$ $di/dt = 100A/\mu s$ ③		420		ns
反向恢复电荷 Reverse Recovery Charge	Q_{rr}			1.1		μC

●热特性

●Thermal Characteristics

参数 PARAMETER	符号 SYMBOL	最大值 MAX		单位 UNIT
		TO-220	TO-220FP	
热阻结-壳 Thermal Resistance Junction-case	R_{thJC}	2.32	5.50	$^\circ C/W$
热阻结-环境 Thermal Resistance Junction-ambient	R_{thJA}	62.5	62.5	$^\circ C/W$

注释(Notes):

- ① 脉冲宽度：以最高结温为限制
Repetitive rating: Pulse width limited by maximum junction temperature
- ② 初始结温=25 $^\circ C$, $V_{DD} = 50V$, $L = 36mH$, $R_G = 25\Omega$, $I_{AS} = 2.0A$
Starting $T_j = 25^\circ C$, $V_{DD} = 50V$, $L = 36mH$, $R_G = 25\Omega$, $I_{AS} = 2.0A$
- ③ 脉冲测试：脉冲宽度 $\leq 300\mu s$ ，占空比 $\leq 2\%$
Pulse Test : Pulse width $\leq 300\mu s$, Duty cycle $\leq 2\%$

N-沟道功率 MOS 管/ N-CHANNEL POWER MOSFET

SIF2N65FB

● 特性曲线



图 1 输出特性曲线, Tc=25°C

Fig1 Typical Output Characteristics, Tc=25°C

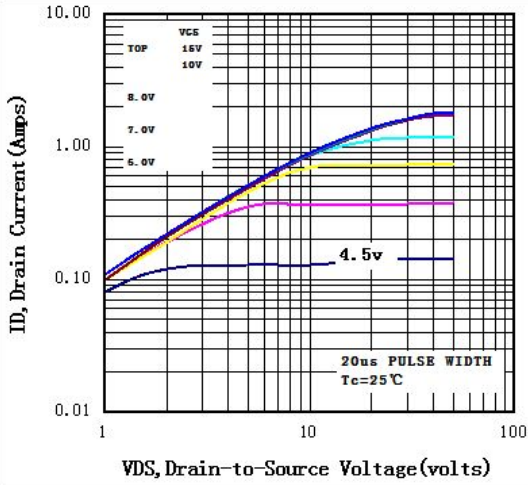

图 2 输出特性曲线, Tc=150°C

Fig2 Typical Output Characteristics, Tc=150°C

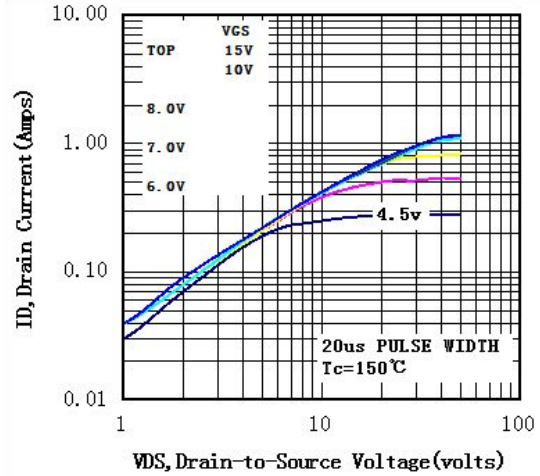

图 3 归一化导通电阻与温度曲线

Fig3 Normalized Resistance Vs. Temperature

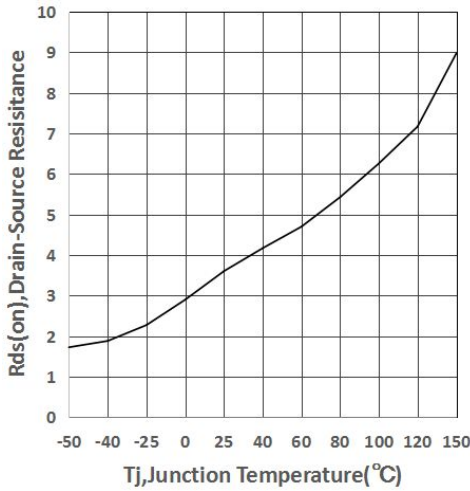

图 4 二极管正向压降曲线

Fig4 Typical Source-Drain Diode Forward Voltage

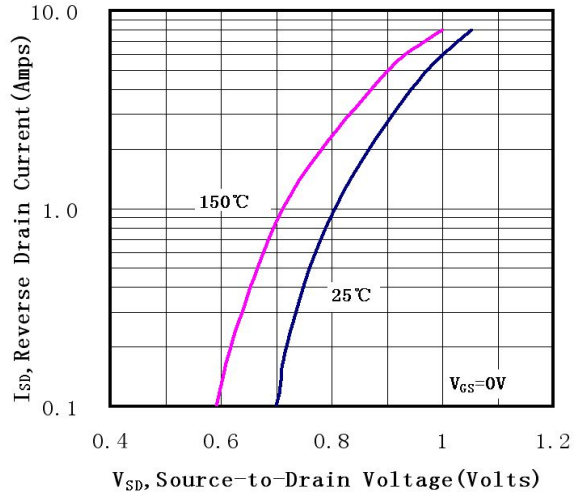

图 5 最大漏极电流与壳温曲线

Fig5 Maximum Drain Current Vs. Case Temperature

N-沟道功率 MOS 管/ N-CHANNEL POWER MOSFET

SIF2N65FB

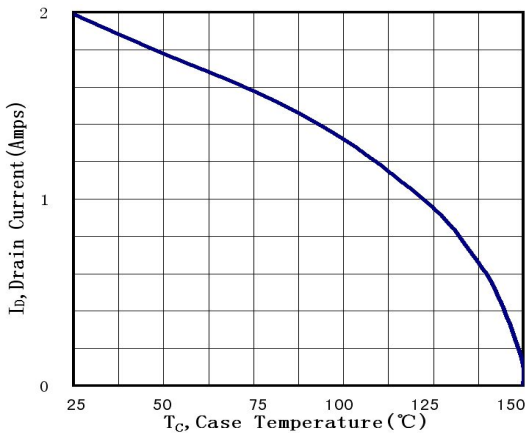
● 特性曲线



图 6-1 SIF2N65FB (TO-220)
最大安全工作区曲线

Fig6-1 Maximum Safe Operating Area

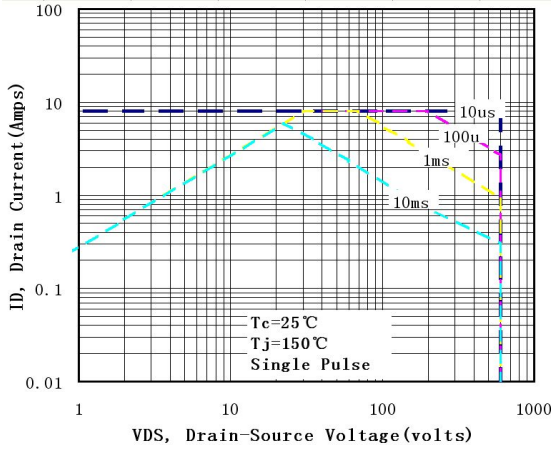

图 6-2 SIF2N65FB (TO-220FP)
最大安全工作区曲线

Fig6-2 Maximum Safe Operating Area

TO-220 封装机械尺寸 TO-220 MECHANICAL DATA

单位：毫米/UNIT: mm

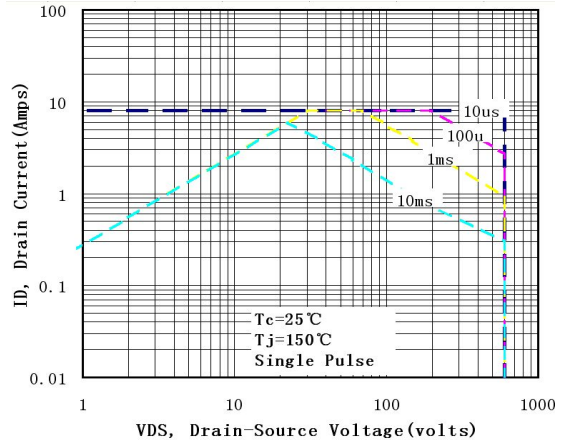
符号 SYMBOL	最小值 min	典型值 nom	最大值 max	符号 SYMBOL	最小值 min	典型值 nom	最大值 max
A	4.00		4.80	E	9.90		10.70
B	1.20		1.50	e		2.54	
B1	1.00		1.40	F	1.10		1.45
b1	0.65		1.00	L	12.50		14.50
c	0.35		0.75	L1	3.00	3.50	4.00
D	15.00		16.50	Q	2.50		3.00
D1	5.90		6.90	Q1	2.00		3.00
				ϕP	3.60		3.90

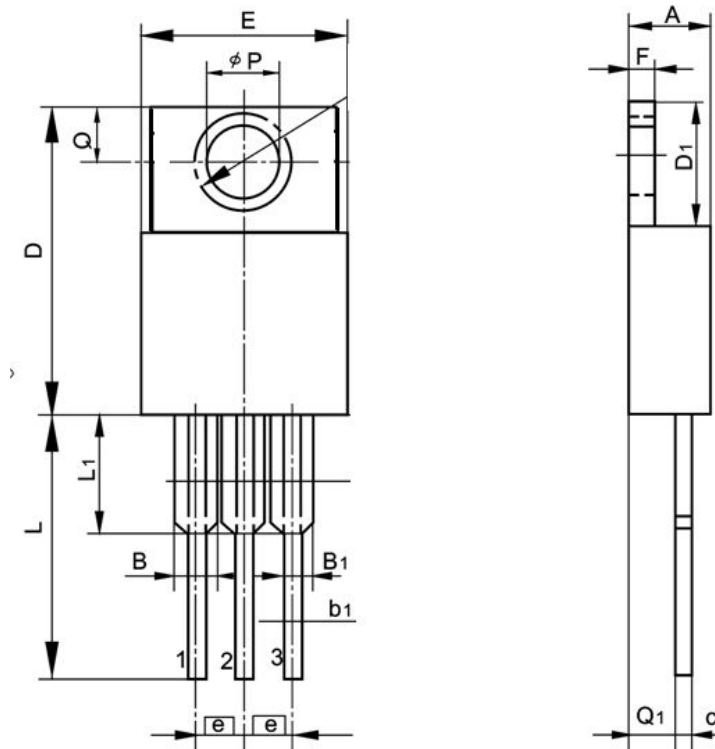



TO-220FP 封装机械尺寸 TO-220FP MECHANICAL DATA

单位:毫米/UNIT: mm

符号 SYMBOL	最小值 min	典型值 nom	最大值 max	符号 SYMBOL	最小值 min	典型值 nom	最大值 max
A	4.40		4.95	e		2.54	
A ₁	2.30		2.90	L	12.50		14.30
b	0.45		0.90	L ₁	9.10		10.05
b ₁	1.10		1.70	L ₂	15.00		16.00
c	0.35		0.90	L ₃	3.00		4.00
D	14.50		17.00	øp	3.00		3.50
D ₁	6.10		9.00	Q	2.30		2.80
E	9.60		10.30				

