



78L12

SOT - 89 Plastic - Encapsulate Regulators

78L12

Three-terminal positive voltage regulator

Features:

Maximum Output current I_{OM} : 0.1A

Output voltage V_O : 12V

Continuous total dissipation

P_D : 0.8W ($T_a = 25^\circ\text{C}$)

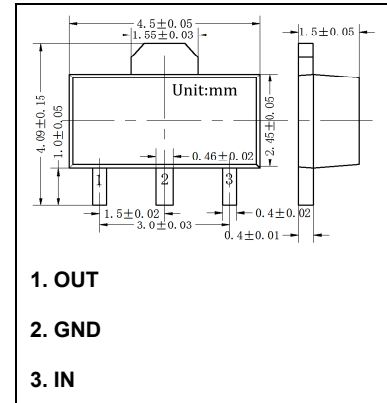

ABSOLUTE MAXIMUM RATINGS (Operating temperature range applies unless otherwise specified)

Parameter	Symbol	Value	Unit
Input Voltage	V_i	35	V
Thermal Resistance from Junction to Ambient	$R_{\theta JA}$	166.7	$^\circ\text{C}/\text{W}$
Operating Junction Temperature Range	T_{OPR}	-25~+125	$^\circ\text{C}$
Storage Temperature Range	T_{STG}	-65~+150	$^\circ\text{C}$

ELECTRICAL CHARACTERISTICS AT SPECIFIED VIRTUAL JUNCTION TEMPERATURE ($V_i=19\text{V}$, $I_o=40\text{mA}$, $C_i=0.33\mu\text{F}$, $C_o=0.1\mu\text{F}$, unless otherwise specified)

Parameter	Symbol	Test conditions	MIN	TYP	MAX	UNIT	
Output voltage	V_o	25°C	11.5	12	12.5	V	
		0-125 $^\circ\text{C}$	$14\text{V} \leq V_i \leq 27\text{V}$, $I_o=1\text{mA}-40\text{mA}$	11.4	12	12.6	V
			$I_o=1\text{mA}-70\text{mA}$	11.4	12	12.6	V
Load Regulation	ΔV_o	$I_o=1\text{mA}-100\text{mA}$, 25°C		22	100	mV	
		$I_o=1\text{mA}-40\text{mA}$, 25°C		13	50	mV	
Line regulation	ΔV_o	$14.5\text{V} \leq V_i \leq 27\text{V}$, 25°C		55	250	mV	
		$16\text{V} \leq V_i \leq 27\text{V}$, 25°C		49	200	mV	
Quiescent Current	I_q	25°C		4.3	6.5	mA	
Quiescent Current Change	ΔI_q	$16\text{V} \leq V_i \leq 27\text{V}$, 0-125 $^\circ\text{C}$			1.5	mA	
	ΔI_q	$1\text{mA} \leq I_o \leq 40\text{mA}$, 0-125 $^\circ\text{C}$			0.1	mA	
Output Noise Voltage	V_N	$10\text{Hz} \leq f \leq 100\text{KHz}$, 25°C		70		$\mu\text{V}/V_o$	
Ripple Rejection	RR	$15\text{V} \leq V_i \leq 25\text{V}$, $f=120\text{Hz}$, 0-125 $^\circ\text{C}$	37	42		dB	
Dropout Voltage	V_d	25°C		1.7		V	

* Pulse test.

TYPICAL APPLICATION

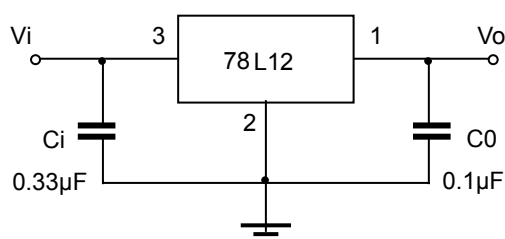

Note : Bypass capacitors are recommended for optimum stability and transient response and should be located as close as possible to the regulators.



Typical Characteristics

Output Characteristics

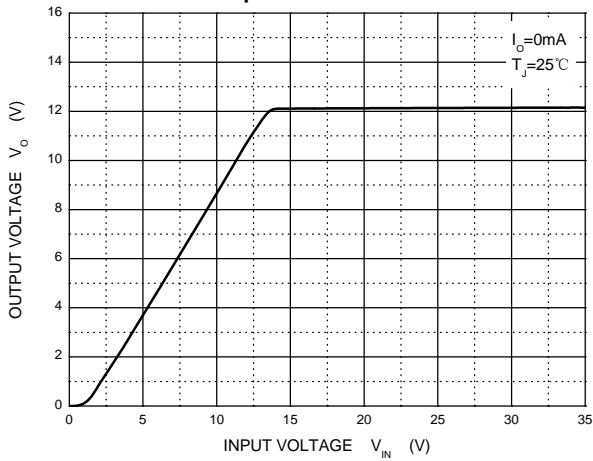

Dropout Characteristics

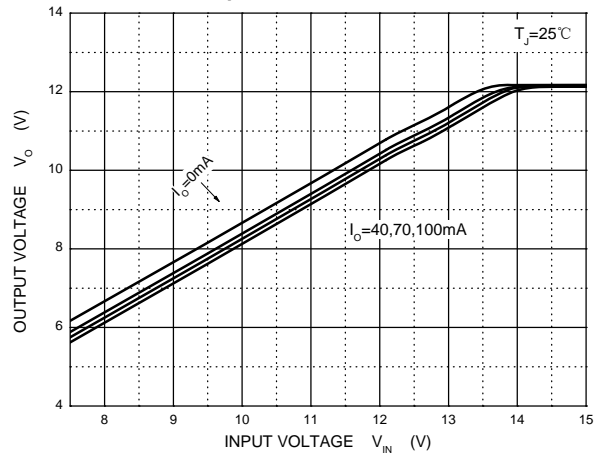

Quiescent Current

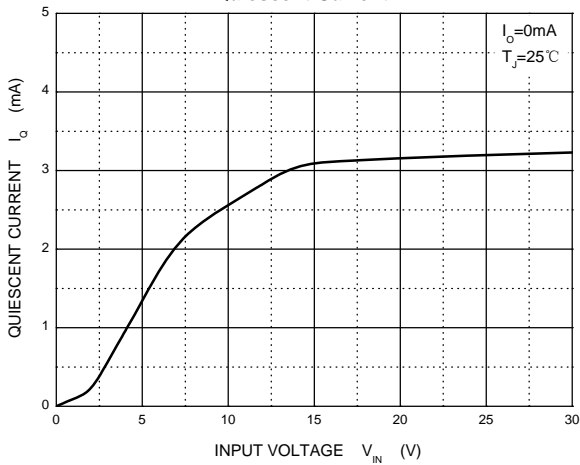

Current Cut-off Grid Voltage

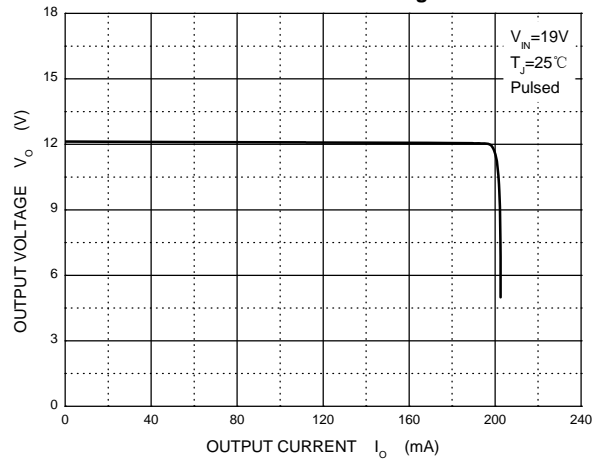

Output Voltage vs Junction Temperature

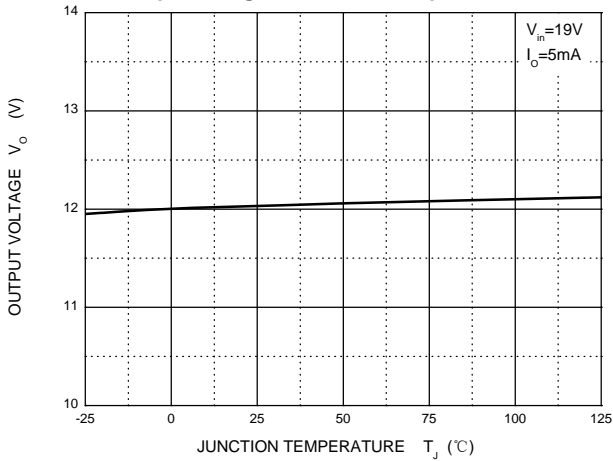

Power Derating Curve

