

General-Purpose CMOS Rail-to-Rail Amplifiers

GENERAL DESCRIPTION

The HT8541/HT8542/HT8544 are single, dual, and quad rail-to-rail input and output single-supply amplifiers featuring very low supply current and 1 MHz bandwidth. All are guaranteed to operate from a 2.7 V single supply as well as a 5 V supply. These parts provide 1 MHz bandwidth at a low current consumption of 45 μA per amplifier.

Very low input bias currents enable the HT8541/HT8542/HT8544 to be used for integrators, photodiode amplifiers, piezoelectric sensors, and other applications with high source impedance. The supply current is only 45 μA per amplifier, ideal for battery operation.

Rail-to-rail inputs and outputs are useful to designers buffering ASICs in single-supply systems. The HT8541/HT8542/HT8544 are optimized to maintain high gains at lower supply voltages, making them useful for active filters and gain stages.

The HT8541/HT8542/HT8544 are specified over the extended industrial temperature range (-40°C to $+125^\circ\text{C}$). The HT8541 is available in 8-lead SOIC, 5-lead SC70, and 5-lead SOT-23 packages. The HT8542 is available in 8-lead SOIC, 8-lead MSOP, and 8-lead TSSOP surface-mount packages. The HT8544 is available in 14-lead narrow SOIC and 14-lead TSSOP surface-mount packages. All MSOP, SC70, and SOT versions are available in tape and reel only.

FEATURES

Single-supply operation: 2.7V to 5.5V

Low supply current: 45 μA /amplifier

Wide bandwidth: 1 MHz

No phase reversal

Low input currents: 4 pA

Unity gain stable

Rail-to-rail input and output

APPLICATIONS

ASIC input or output amplifiers

Sensor interfaces

Piezoelectric transducer amplifiers

Medical instrumentations

Mobile communications

Audio outputs

Portable systems

PIN CONFIGURATIONS

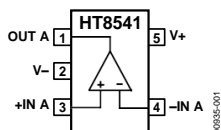


Figure 1. 5-Lead SC70 and 5-Lead SOT-23 (KS and R Suffixes)

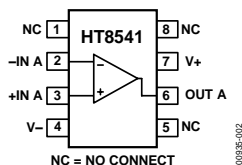


Figure 2. 8-Lead SOIC (R Suffix)

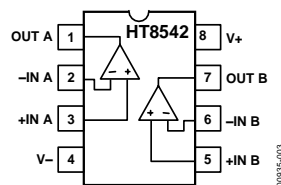


Figure 3. 8-Lead SOIC, 8-Lead MSOP, and 8-Lead TSSOP (R, RM, and RU Suffixes)

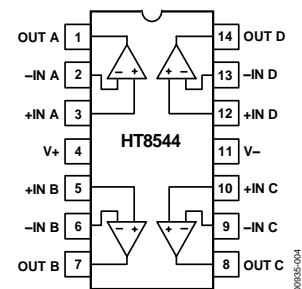
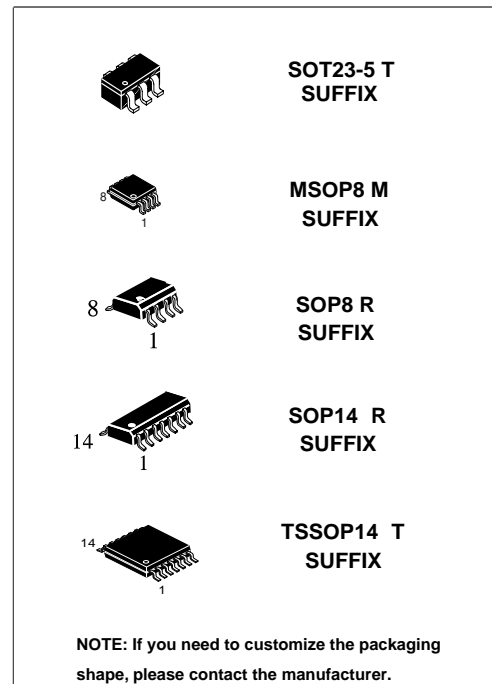


Figure 4. 14-Lead SOIC and 14-Lead TSSOP (R and RU Suffixes)



ELECTRICAL CHARACTERISTICS
 $V_S = 2.7\text{ V}$, $V_{CM} = 1.35\text{ V}$, $T_A = 25\text{ }^\circ\text{C}$, unless otherwise noted.

Table 1.

Parameter	Symbol	Conditions	Min	Typ	Max	Unit
INPUT CHARACTERISTICS						
Offset Voltage	V_{OS}	$-40^\circ\text{C} \leq T_A \leq +125^\circ\text{C}$		1	6	mV
Input Bias Current	I_B	$-40^\circ\text{C} \leq T_A \leq +85^\circ\text{C}$		4	60	pA
Input Offset Current	I_{OS}	$-40^\circ\text{C} \leq T_A \leq +125^\circ\text{C}$			100	pA
					1000	pA
		$-40^\circ\text{C} \leq T_A \leq +85^\circ\text{C}$		0.1	30	pA
Input Voltage Range		$-40^\circ\text{C} \leq T_A \leq +125^\circ\text{C}$			50	pA
Common-Mode Rejection Ratio	CMRR	$V_{CM} = 0\text{ V to } 2.7\text{ V}$ $-40^\circ\text{C} \leq T_A \leq +125^\circ\text{C}$	0	40	45	dB
Large Signal Voltage Gain	A_{VO}	$R_L = 100\text{ k}\Omega$, $V_O = 0.5\text{ V to } 2.2\text{ V}$ $-40^\circ\text{C} \leq T_A \leq +85^\circ\text{C}$	40	38		dB
		$-40^\circ\text{C} \leq T_A \leq +125^\circ\text{C}$	100	50	500	V/mV
		$-40^\circ\text{C} \leq T_A \leq +125^\circ\text{C}$	50	2		V/mV
Offset Voltage Drift	$\Delta V_{OS}/\Delta T$	$-40^\circ\text{C} \leq T_A \leq +125^\circ\text{C}$		4		$\mu\text{V}/^\circ\text{C}$
Bias Current Drift	$\Delta I_B/\Delta T$	$-40^\circ\text{C} \leq T_A \leq +85^\circ\text{C}$		100		fA/°C
		$-40^\circ\text{C} \leq T_A \leq +125^\circ\text{C}$		2000		fA/°C
Offset Current Drift	$\Delta I_{OS}/\Delta T$	$-40^\circ\text{C} \leq T_A \leq +125^\circ\text{C}$		25		fA/°C
OUTPUT CHARACTERISTICS						
Output Voltage High	V_{OH}	$I_L = 1\text{ mA}$ $-40^\circ\text{C} \leq T_A \leq +125^\circ\text{C}$	2.575	2.65		V
Output Voltage Low	V_{OL}	$I_L = 1\text{ mA}$ $-40^\circ\text{C} \leq T_A \leq +125^\circ\text{C}$	2.550			V
Output Current	I_{OUT}	$V_{OUT} = V_S - 1\text{ V}$		15	100	mV
	$\pm I_{SC}$			± 20	125	mV
Closed-Loop Output Impedance	Z_{OUT}	$f = 200\text{ kHz}$, $A_V = 1$		50		Ω
POWER SUPPLY						
Power Supply Rejection Ratio	PSRR	$V_S = 2.5\text{ V to } 6\text{ V}$ $-40^\circ\text{C} \leq T_A \leq +125^\circ\text{C}$	65	76		dB
Supply Current/Amplifier	I_{SY}	$V_O = 0\text{ V}$ $-40^\circ\text{C} \leq T_A \leq +125^\circ\text{C}$	60	38	55	dB
					75	μA
DYNAMIC PERFORMANCE						
Slew Rate	SR	$R_L = 100\text{ k}\Omega$	0.4	0.75		V/ μs
Settling Time	t_s	To 0.1% (1 V step)		5		μs
Gain Bandwidth Product	GBP			980		kHz
Phase Margin	Φ_o			63		Degrees
NOISE PERFORMANCE						
Voltage Noise Density	e_n	$f = 1\text{ kHz}$		40		nV/ $\sqrt{\text{Hz}}$
		$f = 10\text{ kHz}$		38		nV/ $\sqrt{\text{Hz}}$
Current Noise Density	i_n			<0.1		pA/ $\sqrt{\text{Hz}}$

$V_S = 3.0\text{ V}$, $V_{CM} = 1.5\text{ V}$, $T_A = 25\text{ }^\circ\text{C}$, unless otherwise noted.

Table 2.

Parameter	Symbol	Conditions	Min	Typ	Max	Unit
INPUT CHARACTERISTICS						
Offset Voltage	V_{OS}	$-40^\circ\text{C} \leq T_A \leq +125^\circ\text{C}$		1	6	mV
Input Bias Current	I_B	$-40^\circ\text{C} \leq T_A \leq +125^\circ\text{C}$		4	60	pA
		$-40^\circ\text{C} \leq T_A \leq +85^\circ\text{C}$			100	pA
Input Offset Current	I_{OS}	$-40^\circ\text{C} \leq T_A \leq +125^\circ\text{C}$			1000	pA
		$-40^\circ\text{C} \leq T_A \leq +85^\circ\text{C}$		0.1	30	pA
		$-40^\circ\text{C} \leq T_A \leq +125^\circ\text{C}$				50
Input Voltage Range			0		3	V
Common-Mode Rejection Ratio	CMRR	$V_{CM} = 0\text{ V to }3\text{ V}$	40	45		dB
		$-40^\circ\text{C} \leq T_A \leq +125^\circ\text{C}$	38			dB
Large Signal Voltage Gain	A_{VO}	$R_L = 100\text{ k}\Omega$, $V_O = 0.5\text{ V to }2.2\text{ V}$	100	500		V/mV
		$-40^\circ\text{C} \leq T_A \leq +85^\circ\text{C}$	50			V/mV
Offset Voltage Drift	$\Delta V_{OS}/\Delta T$	$-40^\circ\text{C} \leq T_A \leq +125^\circ\text{C}$		4		$\mu\text{V}/^\circ\text{C}$
		$-40^\circ\text{C} \leq T_A \leq +85^\circ\text{C}$				
Bias Current Drift	$\Delta I_B/\Delta T$	$-40^\circ\text{C} \leq T_A \leq +85^\circ\text{C}$		100		fA/ $^\circ\text{C}$
		$-40^\circ\text{C} \leq T_A \leq +125^\circ\text{C}$				
Offset Current Drift	$\Delta I_{OS}/\Delta T$	$-40^\circ\text{C} \leq T_A \leq +125^\circ\text{C}$		2000		fA/ $^\circ\text{C}$
		$-40^\circ\text{C} \leq T_A \leq +125^\circ\text{C}$		25		fA/ $^\circ\text{C}$
OUTPUT CHARACTERISTICS						
Output Voltage High	V_{OH}	$I_L = 1\text{ mA}$	2.875	2.955		V
		$-40^\circ\text{C} \leq T_A \leq +125^\circ\text{C}$	2.850			V
Output Voltage Low	V_{OL}	$I_L = 1\text{ mA}$		32	100	mV
		$-40^\circ\text{C} \leq T_A \leq +125^\circ\text{C}$			125	mV
Output Current	I_{OUT}	$V_{OUT} = V_S - 1\text{ V}$		18		mA
				± 25		mA
Closed-Loop Output Impedance	Z_{OUT}	$f = 200\text{ kHz}$, $A_V = 1$		50		Ω
POWER SUPPLY						
Power Supply Rejection Ratio	PSRR	$V_S = 2.5\text{ V to }6\text{ V}$	65	76		dB
		$-40^\circ\text{C} \leq T_A \leq +125^\circ\text{C}$	60			dB
Supply Current/Amplifier	I_{SY}	$V_O = 0\text{ V}$		40	60	μA
		$-40^\circ\text{C} \leq T_A \leq +125^\circ\text{C}$			75	μA
DYNAMIC PERFORMANCE						
Slew Rate	SR	$R_L = 100\text{ k}\Omega$	0.4	0.8		V/ μs
Settling Time	t_s	To 0.01% (1 V step)		5		μs
Gain Bandwidth Product	GBP			980		kHz
Phase Margin	Φ_o			64		Degrees
NOISE PERFORMANCE						
Voltage Noise Density	e_n	$f = 1\text{ kHz}$		42		nV/ $\sqrt{\text{Hz}}$
		$f = 10\text{ kHz}$		38		nV/ $\sqrt{\text{Hz}}$
Current Noise Density	i_n			<0.1		pA/ $\sqrt{\text{Hz}}$

$V_S = 5.0\text{ V}$, $V_{CM} = 2.5\text{ V}$, $T_A = 25\text{ }^\circ\text{C}$, unless otherwise noted.

Table 3.

Parameter	Symbol	Conditions	Min	Typ	Max	Unit
INPUT CHARACTERISTICS						
Offset Voltage	V_{OS}	$-40\text{ }^\circ\text{C} \leq T_A \leq +125\text{ }^\circ\text{C}$		1	6	mV
Input Bias Current	I_B	$-40\text{ }^\circ\text{C} \leq T_A \leq +85\text{ }^\circ\text{C}$		4	7	mV
		$-40\text{ }^\circ\text{C} \leq T_A \leq +125\text{ }^\circ\text{C}$			60	pA
Input Offset Current	I_{OS}	$-40\text{ }^\circ\text{C} \leq T_A \leq +85\text{ }^\circ\text{C}$			100	pA
		$-40\text{ }^\circ\text{C} \leq T_A \leq +125\text{ }^\circ\text{C}$		0.1	30	pA
		$-40\text{ }^\circ\text{C} \leq T_A \leq +125\text{ }^\circ\text{C}$				50
Input Voltage Range		$-40\text{ }^\circ\text{C} \leq T_A \leq +125\text{ }^\circ\text{C}$			500	pA
Input Voltage Range		$-40\text{ }^\circ\text{C} \leq T_A \leq +125\text{ }^\circ\text{C}$	0		5	V
Common-Mode Rejection Ratio	CMRR	$V_{CM} = 0\text{ V to } 5\text{ V}$ $-40\text{ }^\circ\text{C} \leq T_A \leq +125\text{ }^\circ\text{C}$	40	48		dB
Large Signal Voltage Gain	A_{VO}	$R_L = 100\text{ k}\Omega$, $V_O = 0.5\text{ V to } 2.2\text{ V}$		20	40	V/mV
		$-40\text{ }^\circ\text{C} \leq T_A \leq +85\text{ }^\circ\text{C}$		10		V/mV
Offset Voltage Drift	$\Delta V_{OS}/\Delta T$	$-40\text{ }^\circ\text{C} \leq T_A \leq +125\text{ }^\circ\text{C}$		2		V/mV
Bias Current Drift	$\Delta I_B/\Delta T$	$-40\text{ }^\circ\text{C} \leq T_A \leq +125\text{ }^\circ\text{C}$		4		$\mu\text{V}/^\circ\text{C}$
Offset Current Drift	$\Delta I_{OS}/\Delta T$	$-40\text{ }^\circ\text{C} \leq T_A \leq +85\text{ }^\circ\text{C}$		100		fA/°C
		$-40\text{ }^\circ\text{C} \leq T_A \leq +125\text{ }^\circ\text{C}$			2000	fA/°C
Offset Current Drift		$-40\text{ }^\circ\text{C} \leq T_A \leq +125\text{ }^\circ\text{C}$		25		fA/°C
OUTPUT CHARACTERISTICS						
Output Voltage High	V_{OH}	$I_L = 1\text{ mA}$ $-40\text{ }^\circ\text{C} \leq T_A \leq +125\text{ }^\circ\text{C}$	4.9	4.965		V
Output Voltage Low	V_{OL}	$I_L = 1\text{ mA}$	4.875			V
		$-40\text{ }^\circ\text{C} \leq T_A \leq +125\text{ }^\circ\text{C}$		25	100	mV
Output Current	I_{OUT}	$V_{OUT} = V_S - 1\text{ V}$		30		mA
	$\pm I_{SC}$			± 60		mA
Closed-Loop Output Impedance	Z_{OUT}	$f = 200\text{ kHz}$, $A_V = 1$		45		Ω
POWER SUPPLY						
Power Supply Rejection Ratio	PSRR	$V_S = 2.5\text{ V to } 6\text{ V}$ $-40\text{ }^\circ\text{C} \leq T_A \leq +125\text{ }^\circ\text{C}$	65	76		dB
Supply Current/Amplifier	I_{SY}	$V_O = 0\text{ V}$		45	65	μA
		$-40\text{ }^\circ\text{C} \leq T_A \leq +125\text{ }^\circ\text{C}$			85	μA
DYNAMIC PERFORMANCE						
Slew Rate	SR	$R_L = 100\text{ k}\Omega$, $C_L = 200\text{ pF}$	0.45	0.92		V/ μs
Full-Power Bandwidth	BW_P	1% distortion		70		kHz
Settling Time	t_s	To 0.1% (1 V step)		6		μs
Gain Bandwidth Product	GBP			1000		kHz
Phase Margin	Φ_o			67		Degrees
NOISE PERFORMANCE						
Voltage Noise Density	e_n	$f = 1\text{ kHz}$		42		nV/ $\sqrt{\text{Hz}}$
Current Noise Density	e_n	$f = 10\text{ kHz}$		38		nV/ $\sqrt{\text{Hz}}$
	i_n			<0.1		pA/ $\sqrt{\text{Hz}}$

ABSOLUTE MAXIMUM RATINGS

Table 4.

Parameter	Rating
Supply Voltage (V _s)	6 V
Input Voltage	GND to V _s
Differential Input Voltage ¹	±6 V
Storage Temperature Range	-65°C to +150°C
Operating Temperature Range	-40°C to +125°C
Junction Temperature Range	-65°C to +150°C
Lead Temperature (Soldering, 60 sec)	300°C

¹ For supplies less than 6 V, the differential input voltage is equal to ±V_s.

Stresses above those listed under Absolute Maximum Ratings may cause permanent damage to the device. This is a stress rating only; functional operation of the device at these or any other conditions above those indicated in the operational section of this specification is not implied. Exposure to absolute maximum rating conditions for extended periods may affect device reliability.

THERMAL RESISTANCE

θ_{JA} is specified for the worst-case conditions, that is, a device soldered in a circuit board for surface-mount packages.

Table 5.

Package Type	θ _{JA}	θ _{JC}	Unit
5-Lead SC70 (KS)	376	126	°C/W
5-Lead SOT-23 (RJ)	230	146	°C/W
8-Lead SOIC (R)	158	43	°C/W
8-Lead MSOP (RM)	210	45	°C/W
8-Lead TSSOP (RU)	240	43	°C/W
14-Lead SOIC (R)	120	36	°C/W
14-Lead TSSOP (RU)	240	43	°C/W

ESD CAUTION



ESD (electrostatic discharge) sensitive device.

Charged devices and circuit boards can discharge without detection. Although this product features patented or proprietary protection circuitry, damage may occur on devices subjected to high energy ESD. Therefore, proper ESD precautions should be taken to avoid performance degradation or loss of functionality.

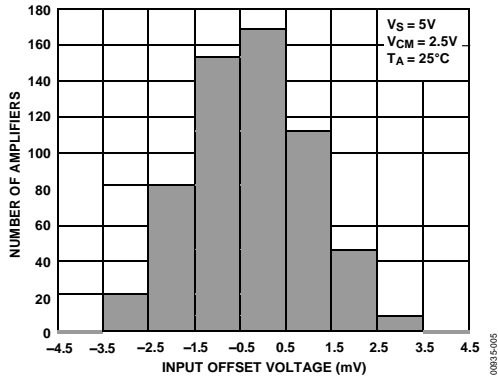
TYPICAL PERFORMANCE CHARACTERISTICS


Figure 5. Input Offset Voltage Distribution

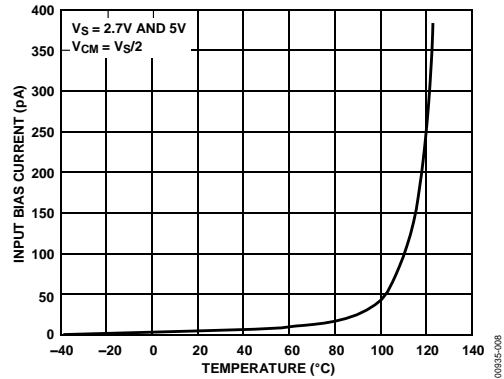


Figure 8. Input Bias Current vs. Temperature

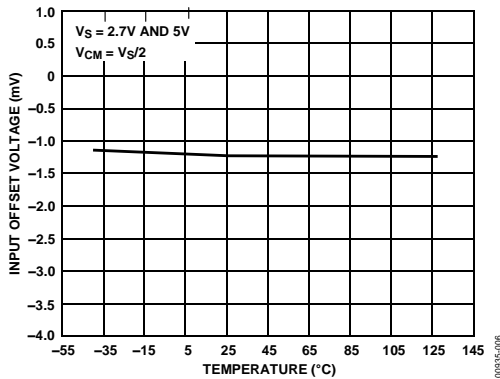


Figure 6. Input Offset Voltage vs. Temperature

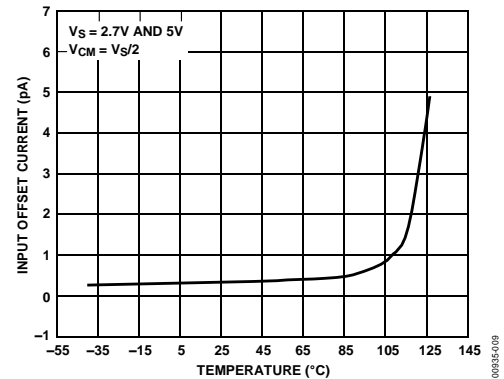


Figure 9. Input Offset Current vs. Temperature

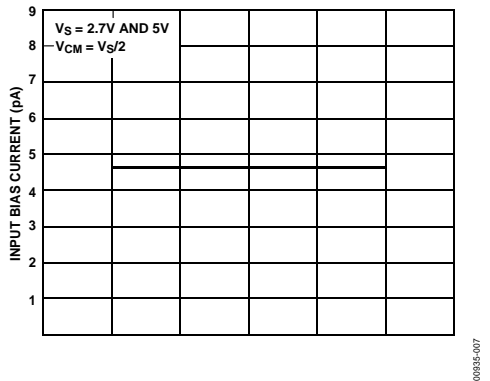


Figure 7. Input Bias Current vs. Temperature

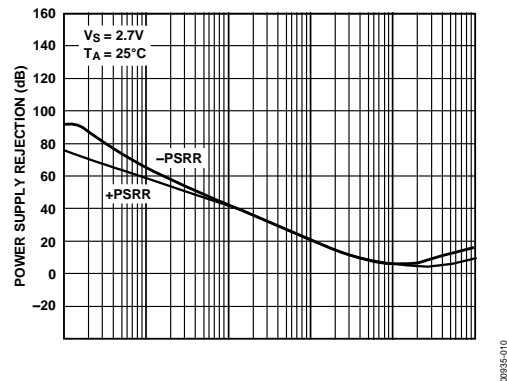


Figure 10. Power Supply Rejection vs. Temperature

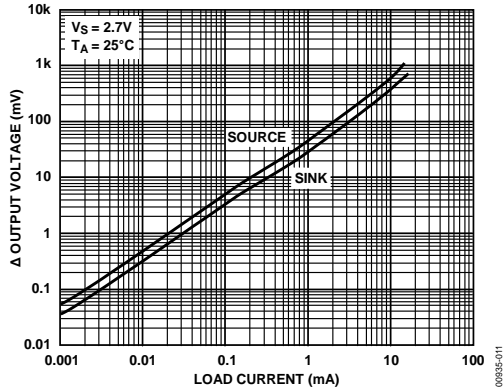


Figure 11. Output Voltage to Supply Rail vs. Load Current

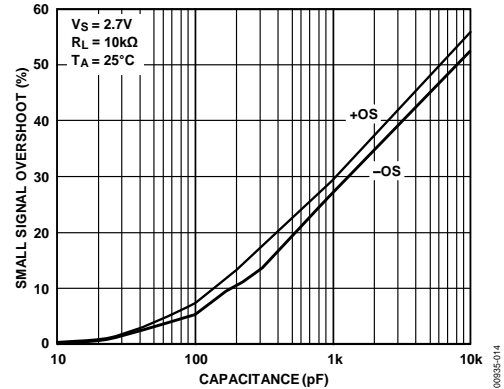


Figure 14. Small Signal Overshoot vs. Load Capacitance

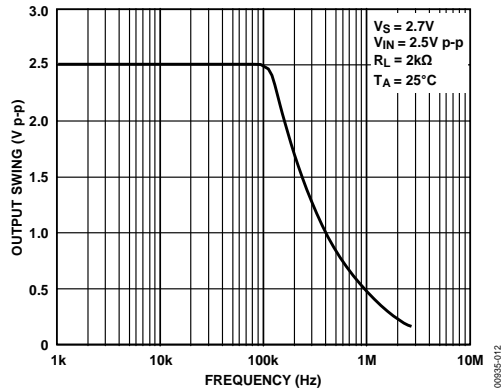


Figure 12. Closed-Loop Output Voltage Swing vs. Frequency

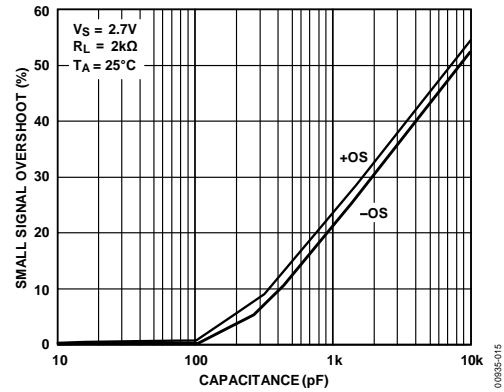


Figure 15. Small Signal Overshoot vs. Load Capacitance

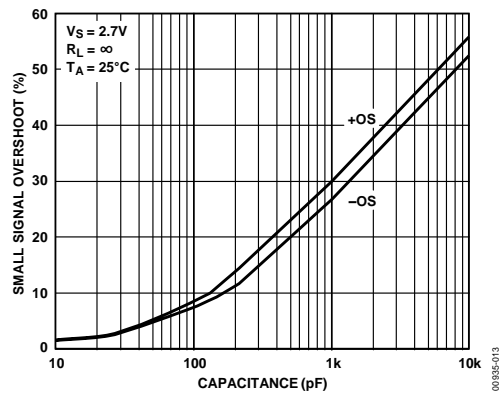


Figure 13. Small Signal Overshoot vs. Load Capacitance

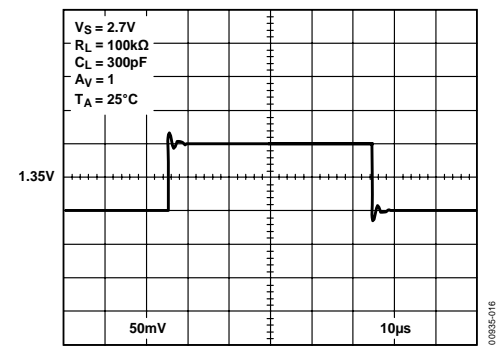


Figure 16. Small Signal Transient Response

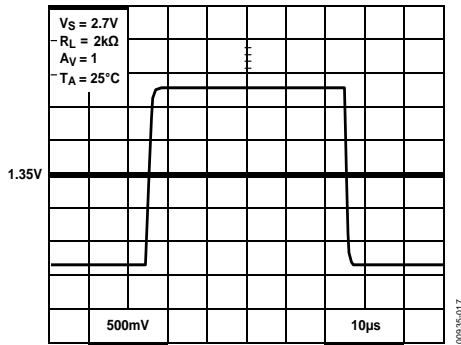


Figure 17. Large Signal Transient Response

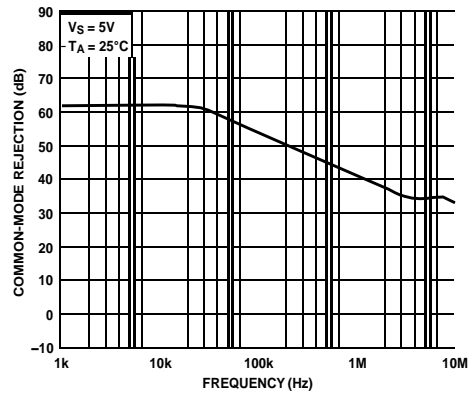


Figure 20. Common-Mode Rejection Ratio vs. Frequency

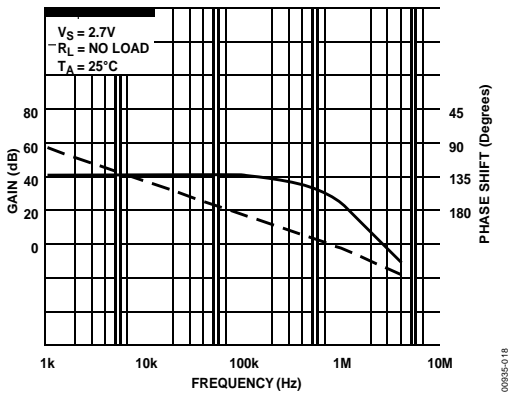


Figure 18. Open-Loop Gain and Phase vs. Frequency

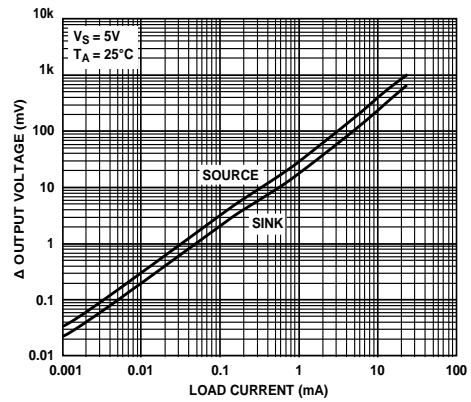


Figure 21. Output Voltage to Supply Rail vs. Frequency

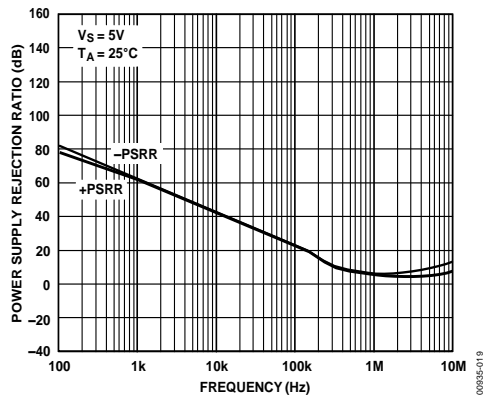


Figure 19. Power Supply Rejection Ratio vs. Frequency

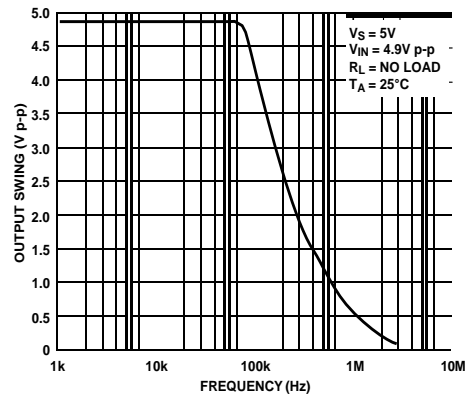


Figure 22. Closed-Loop Output Voltage Swing vs. Frequency

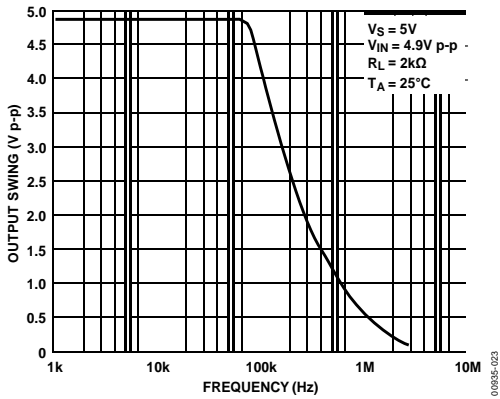


Figure 23. Closed-Loop Output Voltage Swing vs. Frequency

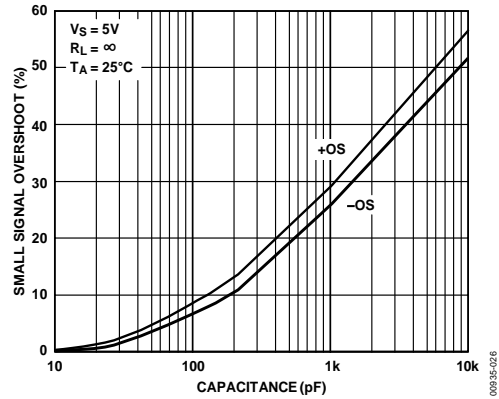


Figure 26. Small Signal Overshoot vs. Load Capacitance

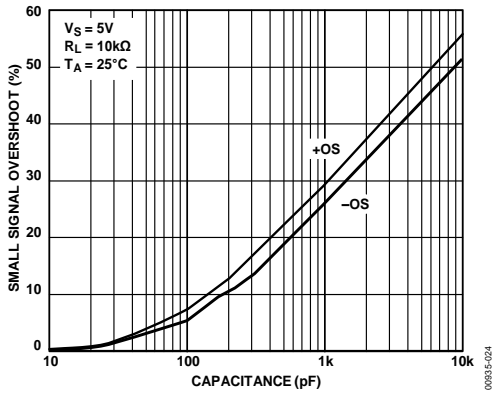


Figure 24. Small Signal Overshoot vs. Load Capacitance

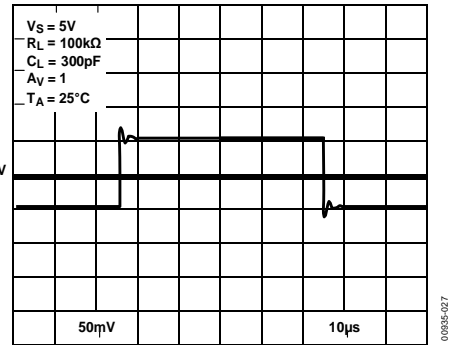


Figure 27. Small Signal Transient Response

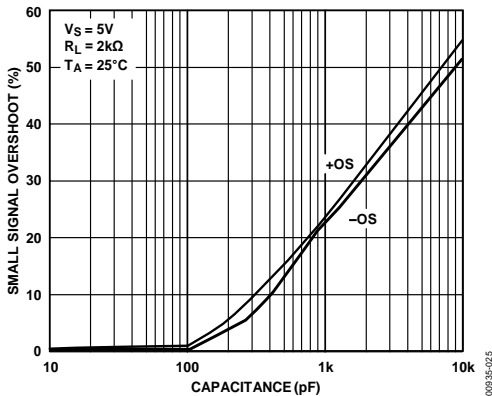


Figure 25. Small Signal Overshoot vs. Load Capacitance

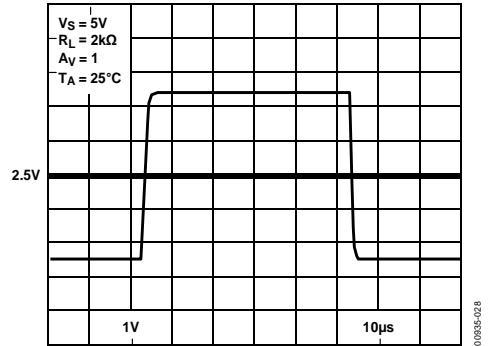


Figure 28. Large Signal Transient Response

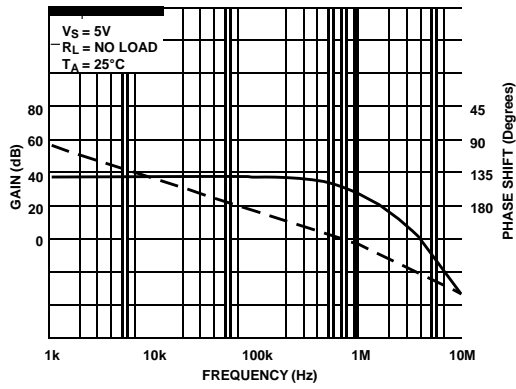


Figure 29. Open-Loop Gain and Phase vs. Frequency

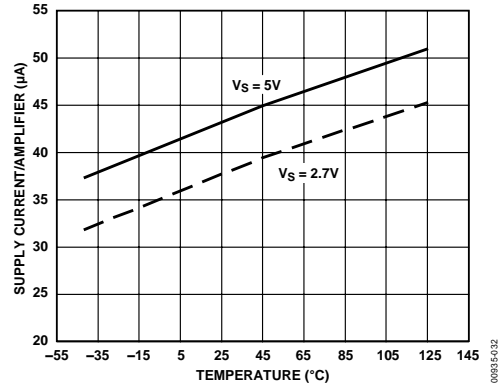


Figure 32. Supply Current per Amplifier vs. Temperature

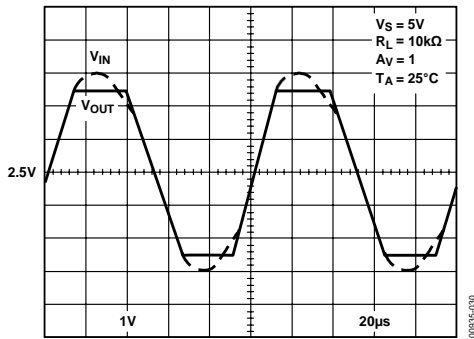


Figure 30. No Phase Reversal

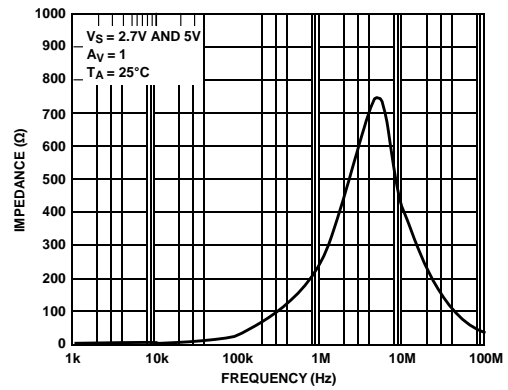


Figure 33. Closed-Loop Output Impedance vs. Frequency

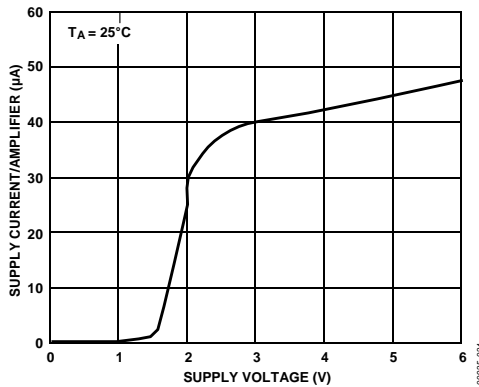


Figure 31. Supply Current per Amplifier vs. Supply Voltage

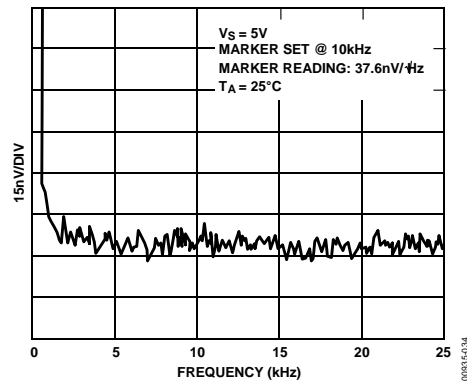


Figure 34. Voltage Noise

APPLICATIONS

NOTCH FILTER

The HT854x have very high open-loop gain (especially with a supply voltage below 4 V), which makes it useful for active filters of all types. For example, Figure 35 illustrates the HT8542 in the classic twin-T notch filter design. The twin-T notch is desired for simplicity, low output impedance, and minimal use of op amps. In fact, this notch filter can be designed with only one op amp if Q adjustment is not required. Simply remove U2 as illustrated in Figure 36. However, a major drawback to this circuit topology is ensuring that all the Rs and Cs closely match. The components must closely match or notch frequency offset and drift causes the circuit to no longer attenuate at the ideal notch frequency. To achieve desired performance, 1% or better component tolerances or special component screens are usually required. One method to desensitize the circuit-to-component mismatch is to increase R2 with respect to R1, which lowers Q. A lower Q increases attenuation over a wider frequency range but reduces attenuation at the peak notch frequency.

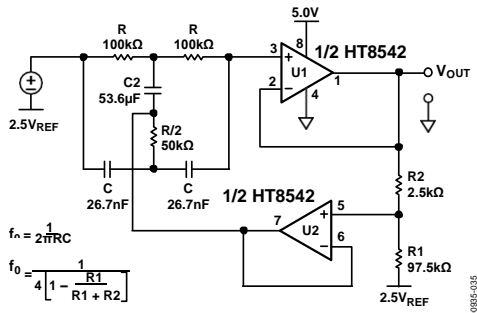


Figure 35. 60 Hz Twin-T Notch Filter, Q = 10

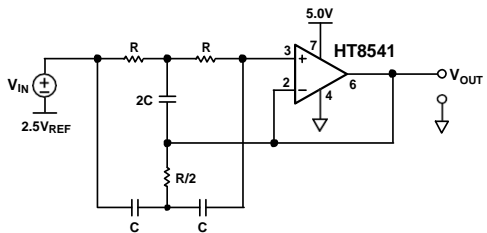


Figure 36. 60 Hz Twin-T Notch Filter, Q = ∞ (Ideal)

Figure 37 is an example of the HT8544 in a notch filter circuit. The frequency dependent negative resistance (FNDR) notch filter has fewer critical matching requirements than the twin-T notch and for the FNDR Q is directly proportional to a single resistor R1. While matching component values is still important, it is also much easier and/or less expensive to accomplish in the FNDR circuit. For example, the twin-T notch uses three capacitors with two unique values, whereas the FNDR circuit uses only two capacitors, which may be of the same value. U3 is simply a buffer that is added to lower the output impedance of the circuit.

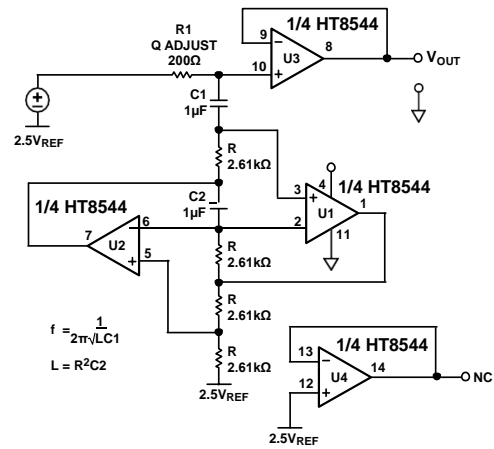


Figure 37. FNDR 60 Hz Notch Filter with Output Buffer

COMPARATOR FUNCTION

A comparator function is a common application for a spare op amp in a quad package. Figure 38 illustrates 1/4 of the HT8544 as a comparator in a standard overload detection application. Unlike many op amps, the AHT854x family can double as comparators because this op amp family has a rail-to-rail differential input range, rail-to-rail output, and a great speed vs. power ratio. R2 is used to introduce hysteresis. The HT854x, when used as comparators, have 5 μs propagation delay at 5 V and 5 μs overload recovery time.

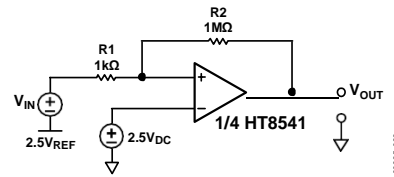


Figure 38. HT854x Comparator Application—Overload Detector

PHOTODIODE APPLICATION

The HT854x family has very high impedance with an input bias current typically around 4 pA. This characteristic allows the HT854x op amps to be used in photodiode applications and other applications that require high input impedance. Note that the HT854x has significant voltage offset that can be removed by capacitive coupling or software calibration.

Figure 39 illustrates a photodiode or current measurement application. The feedback resistor is limited to 10 M Ω to avoid excessive output offset. Also, note that a resistor is not needed on the noninverting input to cancel bias current offset because the bias current-related output offset is not significant when compared to the voltage offset contribution. For best performance, follow the standard high impedance layout techniques, which include:

- Shielding the circuit.
- Cleaning the circuit board.
- Putting a trace connected to the noninverting input around the inverting input.
- Using separate analog and digital power supplies.

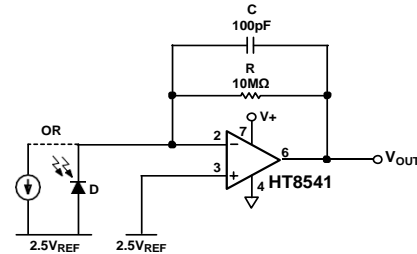
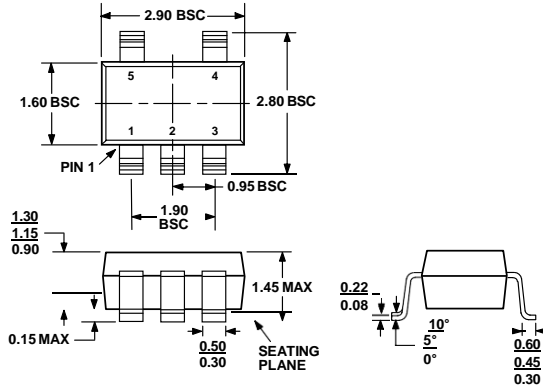


Figure 39. High Input Impedance Application—Photodiode Amplifier

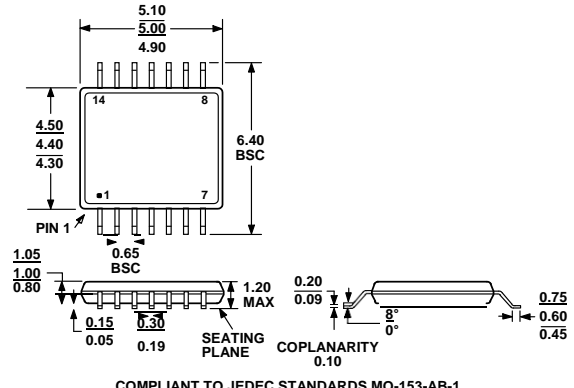
OUTLINE DIMENSIONS



COMPLIANT TO JEDEC STANDARDS MO-178-AA

Figure 40. 5-Lead Small Outline Transistor Package [SOT-23] (RJ-5)

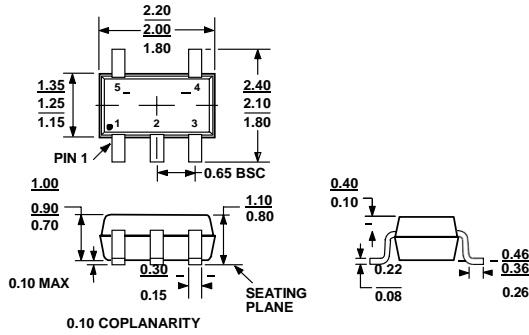
Dimensions shown in millimeters



COMPLIANT TO JEDEC STANDARDS MO-153-AB-1

Figure 41. 14-Lead Thin Shrink Small Outline Package [TSSOP] (RU-14)

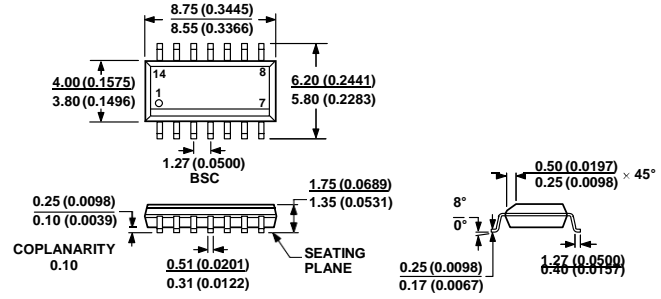
Dimensions shown in millimeters



COMPLIANT TO JEDEC STANDARDS MO-203-AA

Figure 42. 5-Lead Thin Shrink Small Outline Transistor Package [SC70] (KS-5)

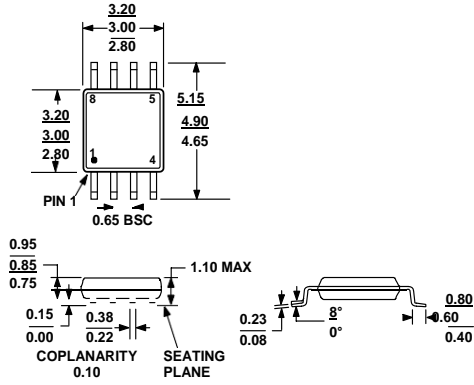
Dimensions shown in millimeters



COMPLIANT TO JEDEC STANDARDS MS-012-AB
CONTROLLING DIMENSIONS ARE IN MILLIMETERS; INCH DIMENSIONS (IN PARENTHESES) ARE ROUNDED-OFF MILLIMETER EQUIVALENTS FOR REFERENCE ONLY AND ARE NOT APPROPRIATE FOR USE IN DESIGN.

Figure 43. 14-Lead Standard Small Outline Package [SOIC_N] Narrow Body (R-14)

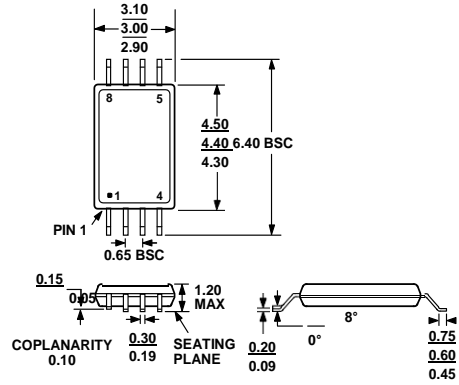
Dimensions shown in millimeters and (inches)



COMPLIANT TO JEDEC STANDARDS MO-187-AA

Figure 44. 8-Lead Mini Small Outline Package [MSOP] (RM-8)

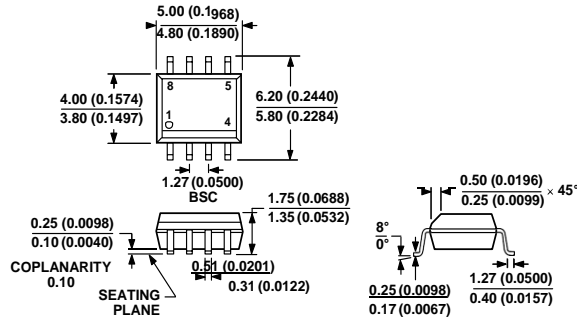
Dimensions shown in millimeters



COMPLIANT TO JEDEC STANDARDS MO-153-AA

Figure 45. 8-Lead Thin Shrink Small Outline Package [TSSOP] (RU-8)

Dimensions shown in millimeters



COMPLIANT TO JEDEC STANDARDS MS-012-A A

CONTROLLING DIMENSIONS ARE IN MILLIMETERS; INCH DIMENSIONS (IN PARENTHESES) ARE ROUNDED-OFF MILLIMETER EQUIVALENTS FOR REFERENCE ONLY AND ARE NOT APPROPRIATE FOR USE IN DESIGN.

Figure 46. 8-Lead Standard Small Outline Package [SOIC_N]

Narrow Body

(R-8)

Dimensions shown in millimeters and (inches)