

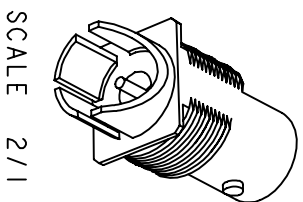

Product NO.		DS801FPS-0059	
REV	DESCRIPTION	DWN	DATE
A	First Issue	W.cheng	2020/09/21
B			APPROVEN
			John Kline

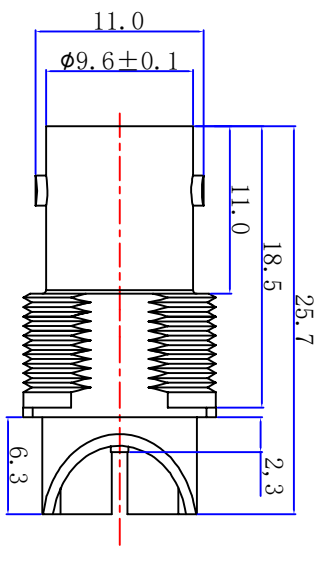

SCALE 2/1

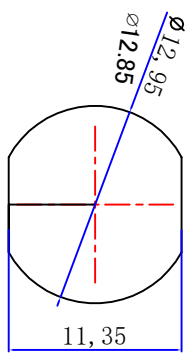

RECOMMENDED  
PANEL CUT-OUT

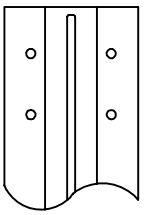
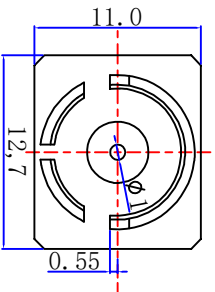
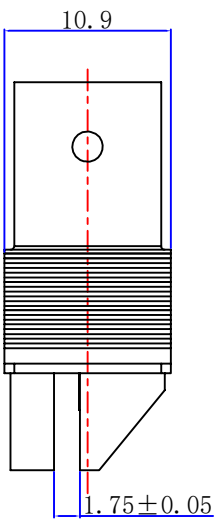

RECOMMENDED  
PCB LAYOUT

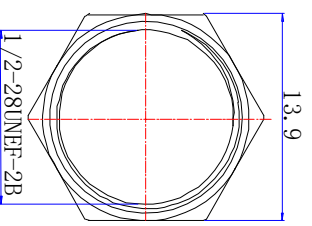
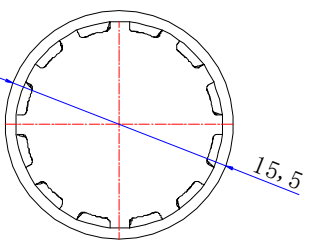
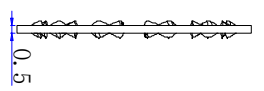

WASHER

NUT

**SPECIFICATIONS:**

Impedance: 75 Ohms  
 Frequency Range: Please refer to the table above  
 VSWR: 1.3max  
 Working Voltage: 500V RMS @ SEA level  
 Insulation Resistance: 5000 Ohms min  
 Temperature Range: -55°C T0 +155°C  
 Drawings products are in line with ROHS standards

1	Body	Zinc	NICKEL
2	Contact pin	phosphor copper	GOLD
3	Insulation	PTFE	White
4	NUT	BRASS	NICKEL
5	WASHER	Iron	NICKEL
NO	Component Number	Material	Finish

**NOTE:**

DRAWN Zelin Zhang  
 CHECKED  
 APPROVALS

Tolerance	0-6 6-30 30-120 Angular	±0.10 ±0.15 ±0.20 ±5°
-----------	----------------------------------	--------------------------------

View	
UNIT	MM
SCALE	1:1

Name: **Dosin Industrial (HK) Co Ltd**  
**Dosin Hardware Electronics Co., Ltd**  
 F-mail: dosin2005@163.com  
 dosin2005@dosin-china.com  
 Web: http://www.dosincomm.com  
 TEL: (0086) 769-81153906  
 FAX: (0086) 769-81875836

BNC JACK FOR PCB CONNECTOR

SIZE	Product NO.	CAD FILE	REV
A	DS801FPS-0059	H/company drawings/BD	A
Date/Time	2020/09/21	SHEET:	1 OF 1