



客户Customer

日期Date: 2021年6月23日

# 承认书 SPECIFICATION

种类: 固态铝电解电容器  
Description: Aluminum Solid Electrolytic Capacitors  
艾华料号 AISHI P/N: SPF0JM152G12C35RAXXX  
系列 SERIES: PF  
规格尺寸 ITEM: 6.3V1500uF(Φ10\*12)  
客户料号 Customer P/N: /  
编号No. : CRS-FX-2106176

批准 Approved by			客户确认 Client Confirmed	
制作 Prepared by	审核 Checked by	批准 Approved by	审核 Checked by	批准 Approved by
				

Please return one copy with your authorized signature when you accept these specifications.  
Please note that no return within 6 months is considered to be approvable.



## 1.概述Scope

此承认书使用于含有导电高分子电解质的PF系列固态电解电容

These specifications specify PF series of the Aluminum Solid Capacitors with Conductive Polymer Electrolyte.

## 2.使用温度范围Operating Temperature Range (-55~105℃)

使用温度范围是指电容在额定电压下可以稳定运行的环境温度范围

Operating temperature range is the range of ambient temperature at which the capacitor can be operated continuously at rated voltage.

## 3.特性Characteristics

除非另有说明，标准的测量和测试环境条件如下：

Unless otherwise specified, the standard range of atmospheric conditions for making measurements and tests are as follows.

环境温度Ambient temperature : 15 to 35℃

大气压力Air pressure : 86kpa to 106kpa

若对结果有疑问，测试则按如下标准进行

If there may be doubt on the results, measurements shall be made within the following limits.

环境温度Ambient temperature : 20±2℃

大气压力Air pressure : 86kpa to 106kpa

## 4.额定电压、浪涌电压和额定温度Rated voltage, Surge voltage and Rated temperature

额定电压 Rated voltage(V)	额定温度 Rated temperature(℃)	浪涌电压 Surge voltage (V)	电压种类 Category voltage(V)
2.5	105	2.88	2.5
6.3	105	7.25	6.3
6.8	105	7.82	6.8
7	105	8.05	7
7.5	105	8.63	7.5
10	105	11.5	10
12	105	13.8	12
16	105	18.4	16
20	105	23	20
25	105	28.75	25
35	105	40.25	35
50	105	57.5	50
63	105	72.45	63
80	105	92	80
100	105	115	100

Issued-date:	Name	Approval Sheet				
2021-6-23	File No	PF	Version	01	Page	3
STANDARD MANUAL						

### 5. 高低温阻抗 Impedance at high and low temperature

阻抗 Impedance at 100kHz at  $-55\pm 3^{\circ}\text{C}$  or  $105\pm 2^{\circ}\text{C}$

阻抗比 Impedance ratio	性能 Performance
$Z(-55^{\circ}\text{C}) / Z(+20^{\circ}\text{C})$	$\leq 1.25$
$Z(105^{\circ}\text{C}) / Z(+20^{\circ}\text{C})$	$\leq 1.25$

### 6.1 电性能 Electrical Characteristics

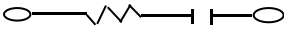
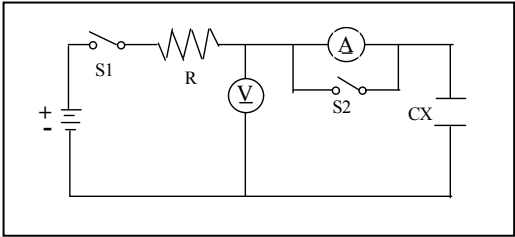
序号 No.	项目 Item	测试方法 Test method	性能 Performance
6.1.1	额定工作电压 Rated voltage	DC: 2.5V~100V	
6.1.2	电容量 Capacitance	测试频率 Measuring frequency : 120Hz 测试电路 Measuring circuit  等效串联电路 Series equivalent circuit	参考特性表 Refer to characteristic table
6.1.3	损失角正切值 Dissipation Factor	测试电压 Measuring voltage: 0.5Vrms or less 直流偏压 DC bias voltage : +1.5~2.0VDC	参考特性表 Refer to characteristic table
6.1.4	等效串联电阻 ESR	测试频率 Measuring frequency: 100kHz 测试温度 Measuring temperature: $20 \pm 2^{\circ}\text{C}$ 测量位置 : 不得超过导针焊点2mm。 Measuring point : 2mm max from the surface of a sealing resin on the lead wire	参考特性表 Refer to characteristic table
6.1.5	漏电流 Leakage current	直流漏电流在 $20^{\circ}\text{C}$ ，有串联 $1000\pm 100\Omega$ 电阻的情况下以直流工作电压且充电2min后测试 DC leakage current shall be measured after 2 minutes application of the DC rated working voltage through the 1000 $\Omega$ resistor at $20^{\circ}\text{C}$  Refer to characteristic table R : $1000\pm 100\Omega$ A : 电流表 DC current meter S1 : 开关 Switch S2 : 电流表保护开关 Switch for protect of current meter V: 电压表 DC voltage meter CX : 测试电容 Testing capacitor	参考特性表 Refer to characteristic table

Issued-date:	Name	Approval Sheet			
2021-6-23	File No	PF	Version	01	Page 4
STANDARD MANUAL					

序号 No.	项目 Item	测试方法 Test method				性能 Performance
		步骤 Step	温度(°C) Temperature	时间 (h) Time	测试项目 Measurement item	
6.1.6	高温&低温特性 Characteristics at High Temperature & Low Temperature					Step 1:容量、损失角在规格值内 Capacitance,tanδ shall meet the specified value
		1	20±2	2	容量、损失角正切、阻抗 Capacitance,tanδ, Z	Step 2:容差±20% Capacitance change:Within±20% of step1
		2	-55±3	2	容量、阻抗 Capacitance, Z	阻抗比率小于1.25  Z (-55°C)/ Z (20°C) Less than 1.25
		3	20±2	0.5		Step 4: 漏电小于0.2CV值或500µA中的任一个较大值的150% Leakage current≤ 150% of the larger values between 0.2CV and 500uA.
		4	105±2	2	阻抗、漏电  Z ,LC	阻抗比率小于1.25  Z (105°C)/ Z (20°C) Less than 1.25
		5	20±2	2	容量、损失角正切 Capacitance,tanδ	Step 5: 容差±5% Capacitance change :Within±5% of step1 损失角在规格值内 tanδ shall meet the specified value.
		备注Remarks : 120Hz : Capacitance,tanδ 100KHz :  Z  ,ESR				

**6.2 耐受能力 Endurance Performance**

序号 No.	项目 Item	测试方法 Test method	性能 Performance
6.2.1	负荷寿命试验 Load Life Test	电容在105±2°C,加载直流电5000小时后,需在室温下放置2小时才可进行测试。 After 5000hours continuous application of DC rated working voltage at 105 ± 2°C,the measurements shall be measured after 2 hours exposed at room temperature.	容量变化:在初始值的±20%内 Capacitance change within ±20% of the initial value 损失角:小于规格值的150% tan δ ≤ 150% of the initial specified value. 等效串联电阻≤规格值的150% ESR ≤ 150% of the initial specified value. 漏电流≤0.2CV值或500µA中的任一个较大值 Leakage current ≤the larger values between 0.2CV and 500uA. 外观:没有明显的损伤 Appearance:No significant damage

Issued-date:	Name	Approval Sheet				
2021-6-23	File No	PF	Version	01	Page	5
STANDARD MANUAL						

序号 No.	项目 Item	测试方法 Test method	性能 Performance
6.2.2	振动试验 Resistance to Vibration	依照JIS C 5102 8.2和 JIS C 5025 To comply with JIS C 5102 8.2 and JIS C 5025 频率: 10到55Hz(1分钟间隔/10→55→10Hz) Frequency: 10 to 55Hz (1 minute interval/10→55→ 10Hz) 振幅: 0.75mm(整体偏移1.5mm) Amplitude : 0.75mm ( Total excursion 1.5mm) 方向: X, Y, Z (3 轴) Direction : X , Y , Z (3 axes) 持续时间: 2小时/轴 (共6小时) Duration : 2 hours / axial (Total 6 hours)	容量在30分钟内测量, 与初始值相比 不应有较大的差异, 其改变在±5%以 内 Capacitance value should not show drastic change compared to the initial capacitance when the value is measured within 30 minutes.Prior to the completion of exam, capacitance change should be within ±5% compared to the initial value after the exam 外观: 导针不得断裂 Appearance: Don't lead wire broken
6.2.3	可焊性 Solder ability	温度: 235 ± 5 °C Temperature : 235 ± 5 °C 持续时间: 2 ± 0.5秒 Duration : 2 ± 0.5 seconds 焊料: 25wt%的松香(JIS K5902)//乙醇(JIS K 8101) Flux: Rosin (JIS K5902)//Ethanol(JIS K8101); About 25 wt. %	至少95%的浸渍表面覆盖有新的焊料 At least 95% of surface area of the dipped portion of the terminal shall be covered with new solder.
6.2.4	耐焊接热 Resistance to soldering heat	(1)焊料浴方法 Solder bath method 温度 Temperature : 260 ± 5 °C 持续时间 Duration : 10 ± 1 seconds 一直到间距为1.0mm的情况下 Until a distance of 1.0mm from the case. (2) Soldering iron method : 温度 Temperature : 400 ± 10 °C 持续时间 Duration : 3 + 1 / - 0 seconds	容量变化在初始值的±5%内 Capacitance change: Within ± 5% of initial capacitance 损失角 ≤ 规格值的130% Tan δ ≤ 130% of the initial specified value. 等效串联电阻 ≤ 规格值的130% ESR ≤ 130% of the initial specified value. 漏电流 ≤ 0.2CV值或500μA中的任一个 较大值 Leakage current ≤ the larger values between 0.2CV and 500uA.
6.2.5	稳态湿热 (恒稳态) Resistance to damp heat (steady state)	温度 Temperature : 60 ± 2 °C 相对湿度 Relative humidity : 90% ~ 95% 持续时间 Duration : 2000 (-0/+48) hrs 使用电压: 无负荷 Applied voltage : without load	电容变化在初始值的±20%内 Capacitance change within ±20% of initial value 损失角 ≤ 规格值的150% tan δ ≤ 150% of the initial specified value. 等效串联电阻 ≤ 规格值的150% ESR ≤ 150% of the initial specified value. 漏电流 ≤ 0.2CV值或500μA中的任一个 较大值 Leakage current ≤ the larger values between 0.2CV and 500uA.

Issued-date:	Name	Approval Sheet				
2021-6-23	File No	PF	Version	01	Page	6
STANDARD MANUAL						

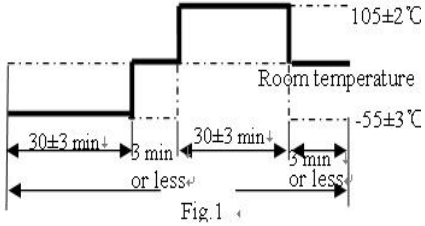
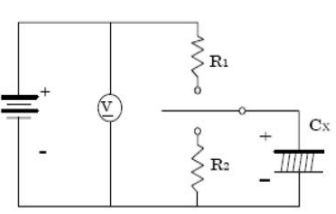
序号 No.	项目 Item	测试方法 Test method	性能 Performance
6.2.6	快速变温 Rapid change of temperature	 <p>使用电压：无负荷 Applied voltage : without load 循环次数：10次 Cycle number : 10 Cycles 测试图:Fig. 1 Test diagram: Fig. 1</p>	容量变化：在初始值的±10%内 Capacitance change : Within ±10% of the initial capacitance 损失角：小于或等于规格值 tanδ ≤ initial specified value. 漏电流≤0.2CV值或500μA中的任一个较大值 Leakage current ≤the larger values between 0.2CV and 500uA.
6.2.7	浪涌电压 Surge voltage	<p>额定浪涌电压充电30s后，在室温下放电5min30s。这一过程重复1000次，每一次循环的时间为6min，测试温度为15°C-35°C。测试电路如下图所示：</p> <p>Rated surge voltage shall be applied (switch on) for 30 seconds and then shall be applied (switch off) with discharge for 5min30 seconds at room temperature . This cycle shall be repeated for 1000 cycles . Duration of one cycle is 6 minutes . Test temperature: 15°C-35°C The test circuit is as follows:</p> <p>Test circuit :</p>  <p>Ⓟ : DC voltmeter R1 : Protective resistor 1kΩ R2 : Discharging resistor 1kΩ Cx : Capacitor under test ( 10pcs )</p> <p>备注：若浪涌电压测试标准不能满足整机实际ON/OFF要求，请在样品阶段与我司RD确认，并将具体测试要求反馈给我司，包括测试电压、浪涌电流、充放频率、循环次数、测试温度及性能表现等。Remark : If the surge voltage test standard is inconsistent with the actual ON/OFF requirements of the machine, Please confirm with our RD at the sample stage.And feedback the specific test requirements to our company, including test voltage,surge current, charge and discharge frequency, cycle times, test temperature and performance, etc.</p>	漏电流≤0.2CV值或500μA中的任一个较大值 Leakage current ≤the larger values between 0.2CV and 500uA. 容量改变在初始值的±20%内 Capacitance change Within±20% of the initial value 损失角≤规格值的150% tanδ≤150% of the initial value. 等效串联电阻≤规格值的150% ESR≤150% of the initial specified value.

Issued-date:	Name	Approval Sheet			
2021-6-23	File No	PF	Version	01	Page
STANDARD MANUAL					

序号 No.	项目 Item	测试方法 Test method	性能 Performance																								
6.2.8	端子强度 Terminal Strength	<p>测试方法 Test method</p> <p>端子抗拉强度： 沿电容器端子引线方向施加拉力（如下表），30±1s Tensile strength of termination: A static load ( stated in the table below) shall be applied to the terminal in the axial direction and acting in a direction away from the body for 30±1sec.</p> <table border="1" style="margin-left: auto; margin-right: auto;"> <tr> <td>引线直径Φ</td> <td>0.45 mm</td> <td>0.5 mm</td> <td>0.6 mm</td> <td>0.8 mm</td> <td>1.0 mm</td> </tr> <tr> <td>拉力N</td> <td colspan="2">5N</td> <td>10N</td> <td colspan="2">25N</td> </tr> </table> <p>端子抗弯强度： 在电容器引线施加固定重力（如下表），然后，将电容器弯折90°后回到原位，再向相反方向弯折90°后回到原位。 上述过程在5秒内完成。 Bending strength of termination: Hang the specified dead weight ( stated in the table below ), then bent the body through 90°, return to the original position.Next bent it in opposite direction through 90°with the same speed, again return to the original position. Carry out this operation in about 5 sec.</p> <table border="1" style="margin-left: auto; margin-right: auto;"> <tr> <td>引线直径Φ</td> <td>0.45 mm</td> <td>0.5 mm</td> <td>0.6 mm</td> <td>0.8 mm</td> <td>1.0 mm</td> </tr> <tr> <td>拉力N</td> <td colspan="2">2.5N</td> <td>5N</td> <td colspan="2">10N</td> </tr> </table>	引线直径Φ	0.45 mm	0.5 mm	0.6 mm	0.8 mm	1.0 mm	拉力N	5N		10N	25N		引线直径Φ	0.45 mm	0.5 mm	0.6 mm	0.8 mm	1.0 mm	拉力N	2.5N		5N	10N		<p>特性 Performance</p> <p>测量电容器应无接触不良、LC 超0.2CV值或500μA中的任一个较大值、开路或短路，无可见机械损伤 When the capacitor is measured, there shall be no intermittent contacts, no over the larger LC values between 0.2CV and 500uA, or open or short-circuiting. There shall be no such mechanical damage.</p>
引线直径Φ	0.45 mm	0.5 mm	0.6 mm	0.8 mm	1.0 mm																						
拉力N	5N		10N	25N																							
引线直径Φ	0.45 mm	0.5 mm	0.6 mm	0.8 mm	1.0 mm																						
拉力N	2.5N		5N	10N																							
6.2.9	高温储存 High temperature storage	<p>电容在105℃±2℃下放置1000小时后，需在室温下放置2小时才可进行测试。 Capacitor is placed under 105 °C ± 2 °C after 1000 hours, should be placed at room temperature 2 hours can be tested.</p>	<p>容量变化：在初始值的±10%内 Capacitance change within ±10% of the initial value 损失角：小于规格值的150% tan δ ≤ 150% of the initial specified value. 等效串联电阻≤规格值的150% ESR ≤ 150% of the initial specified value. 漏电流≤0.2CV值或500μA中的任一个较大值 Leakage current ≤the larger values between 0.2CV and 500uA.</p>																								

备注 REMARKS

如果有任何疑问，在电压处理后测量漏电流。

电压：直流额定电压适用于电容器在105℃下120分钟。

需在室温下放置2小时才可进行测试

If any doubt arises, measure the leakage current after following voltage treatment.

Voltage treatment : DC rated voltage are applied to the capacitors for 120 minutes at 105℃.

The measurements should be measured after 2 hours exposed at room temperature.

Issued-date:	Name	Approval Sheet				
2021-6-23	File No	PF	Version	01	Page	8
STANDARD MANUAL						



7.物料编码PART No. SYSTEM

S	PF	OJ	M	152	G12	C35	R	Axxx
---	----	----	---	-----	-----	-----	---	------

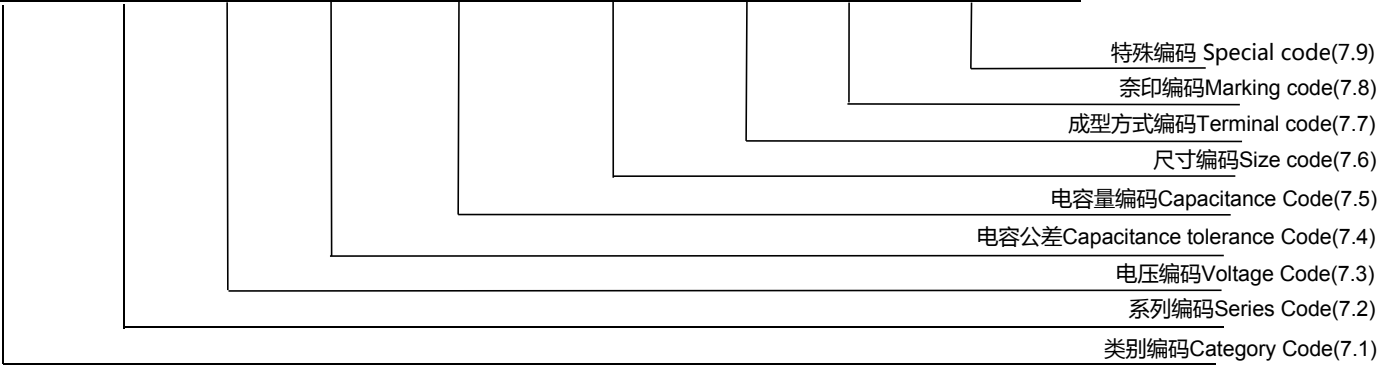

7.1 类别编码Category Code

编码Code	S
类别编码Category Code	固态电容Solid Capacitor

7.2 系列编码Series Code

编码Code	PF
系列编码Series Code	PF

7.3 电压编码Voltage Code

编码Code	0E	0J	1A	1E	1V	1J	1K
电压编码VoltageCode(W.V)	2.5	6.3	10	25	35	63	100

7.4 电容公差Capacitance tolerance

“M”代表 -20 % ~ +20 %      “M”stands for -20 % ~ +20 %

7.5 电容量编码Capacitance Code

编码Code	470	101	221	471	561	681	821	152
电容量Capacitance (uF )	47	100	220	470	560	680	820	1500

7.6 尺寸编码Size Code

编码Code	D10	B09	E05	E08	E11	F09	F11	G12	K18
直径D (Φ)	5	5.5	6.3	6.3	6.3	8	8	10	13
高度H (mm)	10	9	5	8	11	9	11	12	18

7.7 成型方式编码 Terminal Code

编码Code	O00	C35	P35	C48
其他 Other	平豆散装 Platform rubber& Inbulk	平豆剪脚 Platform rubber & Lead Cut3.5±0.3mm	平豆编带 Platform rubber& Taping	平豆剪脚 Platform rubber& Lead Cut4.8±0.3mm

7.8 捺印编码Marking Code

编码Code	S	R
捺印Marking	天蓝Sky blue	红色Red

7.9 特殊编码 Special Code

“Axxx” 代表正常品, “Axxx” stands for normal products.

Issued-date:	Name	Approval Sheet			
2021-6-23	File No	PF	Version	01	Page 9
STANDARD MANUAL					

### 8. 结构Construction

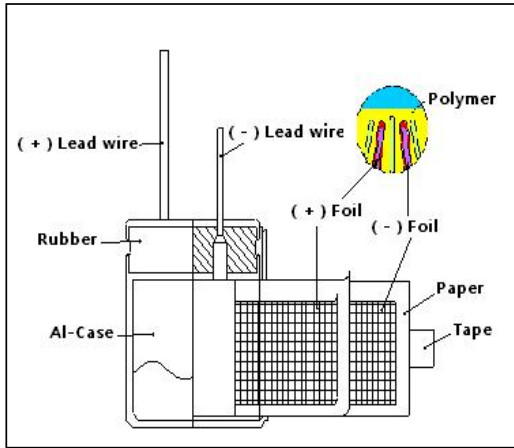

导针:固体镀锡铜包钢线  
 Lead wires : Solid tinned copper weld steel wire  
 导针端子:高纯铝 Al-boss : High pure aluminum  
 电解纸:马尼拉麻Paper : Manila hemp  
 铝箔(正极):高纯铝Al-foil (Anode) : High pure aluminum  
 铝箔(负极):碳箔、高纯铝  
 Al-foil (Cathode) : Carbon foil. High purity aluminum  
 镀膜铝壳:铝+镀膜(耐压600V以上) Coating AL-case:Aluminum+coating(Can withstand voltage above 600V)  
 胶带:聚酯Tape : Polyester  
 胶粒:(树脂)压缩成型IIR-Rubber:Resin ( Compression molding )  
 导针和圆柱端子通过焊接连接在一起  
 The lead wire and the Al-boss are welded together.  
 导针扁平端子与铝箔通过按压连接在一起  
 The Al-tab and the Al-foil are stitched to join together.  
 卷绕的素子外部以阴极箔包裹  
 The outer most Al-foil spiral of the element is cathode.  
 导电高分子用作电解质  
 Conductive polymer is used as the electrolyte.

### 9. 尺寸图Outer dimensions (单位Unit:mm)

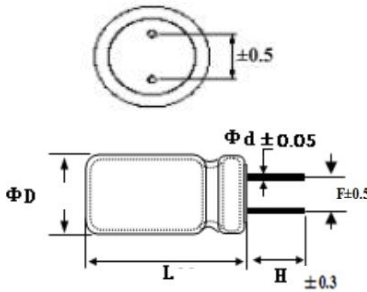

尺寸编码 Size Code	ΦD (mm)	ΦD(mm) Tolerance	L (mm)	L (mm) Tolerance	F (mm)	Φd (mm)	H (mm)
G12	10	-0.1~+0.5	12	-1~+0.5	5	0.6	3.5

### 10. 特性表格Characteristics Table

序号 N o.	艾华料号 AISHI P/N	额定 工作电压 Rated Work Voltage (V.DC)	电容量 Nominal Capacitance 120Hz,20℃ (μF)	电容量 公差 Capacitance Tolerance (%)	温度 Oper Temp (℃)	尺寸 Nominal Case Size D*L (mm)	等效 串联电阻 E.S.R 100KHz 20℃ (mΩmax)	最大漏电流 Leakage current 20℃ (μA max) 2Minutes/W.V	损失 D.F 120Hz, 20℃ (%max)	纹波电流 Ripple Current 100KHz,105℃ (mA.rms)	寿命 Load Life (Hours)
1	SPF0JM152G12C35RAXXX	6.3	1500	-20~+20	105	10*12	11	1890	8	4900	5000

### 纹波电流频率系数Frequency coefficient for ripple current

频率Frequency	120Hz ≤ f < 1 kHz	1 KHz ≤ f < 10 kHz	10 KHz ≤ f < 100 kHz	100 KHz ≤ f < 300 kHz
系数Coefficient	0.05	0.3	0.7	1

Issued-date:	Name	Approval Sheet				
2021-6-23	File No	PF	Version	01	Page	10

### 11. 捺印Marking

除非另有说明，捺印应该清晰地印在电容上

Unless otherwise specified. Capacitor shall be clearly marked on it body.

D :	年编码Year code	2021年
01 :	周编码Week code	
F:	系列Series	PF
额定电容Rated Capacitance		1500
额定电压Rated voltage		6.3
印字油墨为红色The colour of marking ink is red.		

年份代码

年份	2020	2021	2022	2023	2024	2025	2026	2027
代码	C	D	E	F	H	J	K	N
年份	2028	2029	2030	2031	2032	2033	2034	2035
代码	P	Q	S	T	U	V	X	Y

### 12. 导针成型方式Forming Lead Type

12.1 剪脚Lead Cut (单位Unit: mm)

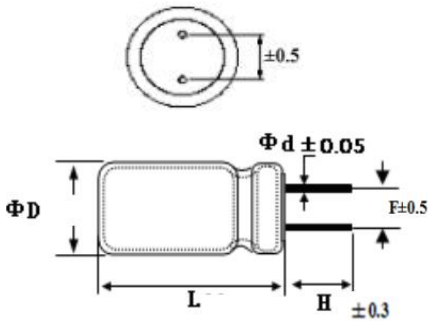

剪脚 Lead Cut Only	ΦD	Φ5		Φ6.3			Φ8		Φ10	
		L	L max	5	8	10	9	11	12	18
L max		8	14	6	9	11	9.5	11.5	12.5	18.5
F		2	2	2.5	2.5	2.5	3.5	3.5	5	5
H		3.5	3.5	3.5	3.5	3.5	3.5	3.5	3.5	3.5
Φd		0.5	0.5	0.5	0.5	0.5	0.6	0.6	0.6	0.6

### 13. 包装Packing

包装标签标示Packing Label Marked

(下面的项目应该标志在标签上the following items shall be marked on the label)

(盒内或包内Inside box or bag)

1)系列series 2)料号P/N 3)额定电容Rated capacitance 4)额定电压Rated Voltage

5)数量quantity 6)尺寸size

7)批号LOT Number :

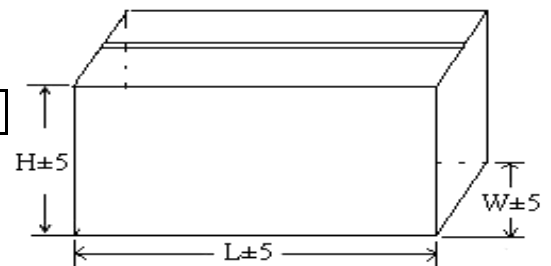
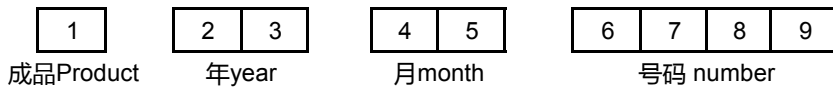

Issued-date:	Name	Approval Sheet				
2021-6-23	File No	PF	Version	01	Page	11
STANDARD MANUAL						

### 13.1 散装包装In bulk Packing

散装Bulk: 标准Standard & 剪脚Cutting

分类Classification	标准品 Standard			剪脚品 Cutting		
	尺寸 Case size D*L(mm)	袋Bag (pcs)	内盒Inner box 290x215x160 (mm)	外箱Outer carton 450x310x350 (mm)	袋Bag (pcs)	内盒Inner box 290x215x160 (mm)
φ5	1000	9000	36000	1000	12000	48000
φ5.5	1000	8000	32000	1000	9000	36000
φ6.3	1000	8000	32000	1000	9000	36000
φ8	500	4000	16000	1000	6000	24000
φ10	500	3000	12000	500	3000	12000

Issued-date:	Name	Approval Sheet				
2021-6-23	File No	PF	Version	01	Page	12
STANDARD MANUAL						

## 14. 操作注意事项 Operating Precautions

### 14.1 极性 Polarity

AishiCAP是具有正负极的固态铝电解电容，使用中不可反接，若接反，则电容会因为漏电流不断增大或短路而造成寿命缩短。  
AishiCAP is a solid aluminum electrolytic capacitor with positive and negative electrodes. Do not reverse the polarity when using. If it is used with the polarities reversed, its life may shorten because of increasing leakage current or short circuit.

### 14.2 禁止电路 Prohibited circuits

因为焊接及其它动作可造成电容的漏电流增加，AishiCAP不可使用在下列电路中：

Since problems can be expected due to leakage current increasing during soldering and other processes, AishiCAP cannot be used in the following circuits

- 1)高阻抗电路1) High impedance circuits ;
- 2)耦合电路2) Coupling circuits ;
- 3)时限恒量电路3) Time constant circuits ;
- 4)为提高耐电压而串联两个或多个电容于电路中  
4) Connection of two or more capacitors in series for higher withstand voltage ;
- 5)电路因漏电流过大而有坏的影响5)Circuits to get bad influence by big leakage current

\* 除漏电流的波动上升外，电容的使用条件如在承认书中规定的高温 and 低温，温热和耐受性条件都会影响电容量。若电容作为时限恒量电容使用，因其对电容量的变动的敏感性，电容量的改变会造成影响。不要将其作为时限恒量电容使用，同时若因电压原因要串联多个AishiCAP电容，请联系湖南艾华集团股份有限公司。

\* In addition to the leakage current fluctuation above, the operational conditions such as characteristics at high and low temperature, damp heat and endurance stipulated in the specifications will affect the capacitance. The fluctuation of the capacitance may cause problem if it is used as a time constant capacitor, which is extremely sensitive to the fluctuation of the capacitance. Do not use it as a time constant capacitor. Additionally, please contact Hunan Aihua Group Co., Ltd. for usage of two or more AishiCAP in series for voltage proof.

### 14.3 电压 Over voltage

电压若超过额定电压，即便只是一瞬间也可能造成短路

Over voltage exceeding the rated voltage may not be applied even for an instant as it may cause a short circuit.

### 14.4 快速充放电 Rapid charge and discharge

快速充放电是不适用的（为了维持高的可靠性）。若充放瞬间电流超过10A或10倍允许纹波电流超过10A，为防止快速的充放电造成电容短路、漏电流增大及容量衰减，电路中应加上一个保护电路用以分流过大的电流。

Rapid charging and discharging is unsuitable (for maintenance of high-proof reliability). If the instantaneous current of charging and discharging is more than 10A or 10 times of the allowable ripple current is more than 10A, in order to prevent the capacitor short, leakage increase and capacity reduction caused by rapid charging and discharging, a protection circuit shall be added to the circuit to reduce the excessive current.

### 14.5 焊接注意事项 Considerations when soldering

焊接条件要在承认书的规定范围内。若没有遵守承认书的条件，则电容漏电流可能急剧增加，容量衰减。

The soldering conditions are to be within the range prescribed in specifications. If the specifications are not followed, there is a possibility of the cosmetic deflection, the intensive increase of leakage current, and the capacitance reduction.

使用需知 Things to be noted before mounting.

(a) 已安装过的或加过电压的AishiCAP请勿再使用。经历了周期性电性能测试的AishiCAP不可再用。

(a) Do not reuse AishiCAP that have been assembled in a set and energized. Excluding AishiCAP that have been removed for measuring electrical characteristics during a periodic inspection, AishiCAP cannot be reused.

Issued-date:	Name	Approval Sheet				
2021-6-23	File No	PF	Version	01	Page	13
STANDARD MANUAL						

(b) AishiCAP贮藏一年时间后，漏电流可能会增大，使用前，请在105℃，额定电压及接有1 kΩ电阻的条件下充电2小时。

(b) Leakage current may increase when AishiCAP are stored for one year. In this case, apply rated voltage for 2 hours at 105℃ with load of 1 kΩ resistor.

(c) Reflow soldering回流焊接

Do not apply radial lead type capacitors to reflow soldering. 插件型产品不适用于回流焊接作业

(d) Handling after soldering焊接后处理

在这之后，不要倾斜，弯曲或扭曲AishiCAP Do not tilt, bend or twist the AishiCAP after it

不可通过抓捏AishiCAP来移动印刷电路板Do not move the PCB with catching AishiCAP itself.

堆叠印刷电路板时确保AishiCAP没有碰触到其它电路板或部件

When stacking PCB make sure that the AishiCAP does not touch other PCB or components.

不可将AishiCAP与其它物品堆放Do not dump the AishiCAP with objects.

#### 14.6 使用AishiCAP于工业设备Use of AishiCAP for industrial equipments

为确保AishiCAP在工业设备上的可靠性，设计必须与之相符。

To ensure reliability when the AishiCAP is used in industrial equipments, design must allow for its

#### 14.7 使用AishiCAP于生命保障系统Use of AishiCAP for human life equipments

若使用于与人类生命有关的设备上（如空间设备、航空设备、原子设备等），请与湖南艾华集团股份有限公司详细咨询，不要使用没有湖南艾华集团股份有限公司承认文件的AishiCAP。

In case of using in equipments regarding human life(e.g. Space equipment, aeronautic equipment and atomic equipment etc.), be sure to talk over the matter with Hunan Aihua Group Co., Ltd.

#### 14.8 贮存Storage

1) 请将AishiCAP贮存于温度在5to 35℃之间，相对湿度在75%以下的没有阳光直射的环境中，如果可能可贮存于包裹中。(如果在35到85℃，他应该少于三个月)

1) Store AishiCAP with the temperature range between 5to 35℃ (If between 35 to 85℃, it should be less than three months), and the relative humidity of 75% or less without direct sunshine and store AishiCAP in the package states if possible.

2) AishiCAP请在使用前再打开包装袋并且快速用完。

AishiCAP are recommended that you shall open the bag just before use and AishiCAP shall be used up.

3) 不要在有水、盐水、油及凝结状况的地方贮存AishiCAP

Never store AishiCAP in which it is directly exposed to water, brine, oil or in condensation status.

4) 禁止在含有毒气体的区域放置AishiCAP（如：硫化氢、亚硫酸、亚硝酸、氯气、氨水等）

Never store AishiCAP in any area filled with poisonous gases(including hydrogen sulfide, sulfurous acid, nitrous acid, chlorine and ammonia).

5) 禁止在有紫外线或放射性辐射的区域放置AishiCAP。

Never store AishiCAP in any area to which ultraviolet and/or radial rays are radiated.

#### 6) 存储时间storage time

开封前：出货后一年内Before unseal : within 1 year after delivery

开封后：打开后1月内After seal : within 1 month from opening

存放时间超过3年的电解电容器应报废处理 If storage time more than three years,the products need to be discarded

#### 14.9 清洗Cleaning

关于HCFC，可用高浓酒精，石油，萜烯，水和表面活性剂以及别的溶剂（单独或混合使用）浸泡，用超声波，煮沸，蒸发等方法按制作者的建议清洗。更多详情请联系。

Concerning about HCFC, higher alcohol system, petroleum system, terpene system, water system with surface active agent and other solvents the washing way (separateness or combinations) by soak, ultrasonic wave, boil, vapor etc. is confirmed under the maker's recommendation. Please contact us if you require further details.

Issued-date:	Name	Approval Sheet				
2021-6-23	File No	PF	Version	01	Page	14
STANDARD MANUAL						

## 14.10 为AishiCAP设计电路的说明 Notes on circuit designs for AishiCAP

## 14.10.1 执行 Performance

在承认书中指定的额定性能范围内使用AishiCAP。

Use AishiCAP within the rating and performance ranges defined in this specifications.

## 14.10.2 使用温度和纹波电流 Operating temperature and ripple current

如果AishiCAP的使用温度超过了上限温度（105℃）或是有过载纹波电流通过，则有较大可能使寿命缩短，或漏电流增大，造成AishiCAP失效。

If AishiCAP is used at a temperature higher than the upper category temperature(105℃), or excess ripple current flows through AishiCAP, there are high possibilities of life cycle reduction or leakage current increasing to cause AishiCAP defective.

## 14.10.3 漏电流 Leakage current

漏电流会因焊接条件而有些微的上升，加载直流电压可使电容自我修复，漏电流逐渐减小。

The leakage current of AishiCAP may increase slightly by soldering conditions. The application of DC voltage enables the capacitors to be repaired by itself and this leads the leakage current to be smaller gradually.

## 14.10.4 使用电压 Applied voltage

为了保证AishiCAP的可靠性，加载到AishiCAP上的电压最好小于其额定电压。直流加交流电压的峰值应小于额定电压。

For the reliability of AishiCAP, it is recommended that the voltage applied to AishiCAP should be less than the rated voltage. Peak value of the the dc and ac voltage should not exceed its rated voltage.

## 14.10.5 失效模式 Failure mode

AishiCAP含有导电聚合物，其寿命的终止大部分是由于偶然失效模式，主要是短路。如果短路，AishiCAP将会因持续电流流过而过热，然后铝壳会因内部压力的增加而脱离电容。

AishiCAP contains a conductive polymer. The life ends mostly due to random failure mode, mainly short circuit. In case of short circuit, AishiCAP can be overheated by continuous current flow, then case of AishiCAP would be removed by internal pressure increasing.

## 14.10.6 变更提前通知 Advance consultation for changing

如果承认书改变，我们会提前通知

It is conducted under an advance consultation with you if this specification is changed.

Issued-date:	Name	Approval Sheet				
2021-6-23	File No	PF	Version	01	Page	15
STANDARD MANUAL						