

Specification Sheet for Approved

Customer Name:	
Customer Part No.:	
Ceaiya Part No:	CR4030 Series
Spec No:	L166

【For Customer Approval Only】

If you Approval, Please Stamp

【RoHS Compliant Parts】

Approved By	Checked By	Prepared By
李庆辉	刘志坚	劳水花

Shenzhen Ceaiya Electronics Co., Ltd.

地址 1: 深圳市龙华区观湖街道鹭湖社区观盛二路 5 号捷顺科技中心 B706

地址 2: 广东省东莞清溪镇青滨东路 105 号力合紫荆智能制造中心 10 栋

Http://www.szceaiya.com

Tel: 0769-89135516

Fax: 0769-89135519

【Version of Changed Record】

Rev.	Effective Date	Changed Contents	Change Reasons	Approved By
A0	2021.11.11	New release	/	Li qing hui

1. Shape and Dimension (Unit:mm)

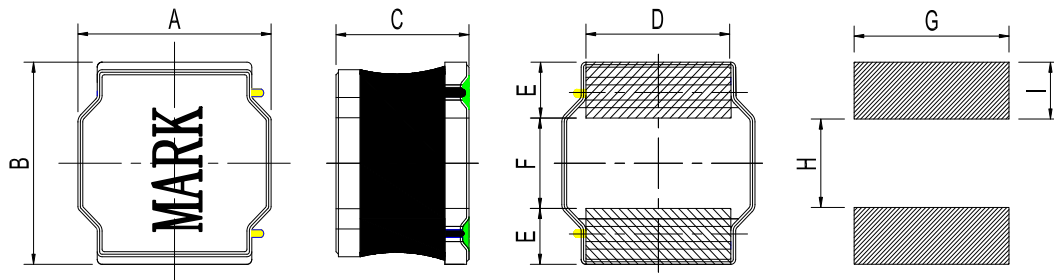

注：喷码尺寸长 2.5±0.5mm, 宽 2.0±0.5mm

A	B	C	D	E	F	G	H	I
4.0 ± 0.3	4.0 ± 0.3	3.0Max	3.3±0.3	1.0±0.3	2.0±0.3	3.7 Ref	1.9 Ref	1.1 Ref

2. Electronic Characteristics List

Part Number	Inductance (uH)	Tolerance (±%)	DCR(mΩ) ±30%	Isat (A)	Irise (A)	Test Condition	Marking
CR4030-R47N	0.47	30	11	7.50	4.00	100kHz /0.25V	R47
CR4030-R56N	0.56	30	14	6.00	4.00	100kHz /0.25V	R56
CR4030-1R0N	1.0	30	15	5.90	3.40	100kHz /0.25V	1R0
CR4030-1R5N	1.5	30	25	4.85	3.30	100kHz /0.25V	1R5
CR4030-1R8N	1.8	30	30	4.25	3.20	100kHz /0.25V	1R8
CR4030-2R2M	2.2	20	35	4.10	2.95	100kHz /0.25V	2R2
CR4030-3R3M	3.3	20	40	3.30	2.40	100kHz /0.25V	3R3
CR4030-3R6M	3.6	20	53	3.10	2.30	100kHz /0.25V	3R6
CR4030-3R9M	3.9	20	57	3.00	2.10	100kHz /0.25V	3R9
CR4030-4R7M	4.7	20	60	2.90	2.00	100kHz /0.25V	4R7
CR4030-5R6M	5.6	20	70	2.75	1.95	100kHz /0.25V	5R6
CR4030-6R8M	6.8	20	75	2.60	1.70	100kHz /0.25V	6R8
CR4030-7R5M	7.5	20	90	2.20	1.65	100kHz /0.25V	7R5
CR4030-8R2M	8.2	20	100	2.10	1.60	100kHz /0.25V	8R2
CR4030-100M	10	20	115	1.95	1.50	100kHz /0.25V	100
CR4030-120M	12	20	140	1.70	1.35	100kHz /0.25V	120
CR4030-150M	15	20	190	1.65	1.15	100kHz /0.25V	150
CR4030-180M	18	20	215	1.40	1.10	100kHz /0.25V	180
CR4030-220M	22	20	225	1.30	1.00	100kHz /0.25V	220
CR4030-270M	27	20	320	1.25	0.90	100kHz /0.25V	270
CR4030-330M	33	20	330	1.10	0.84	100kHz /0.25V	330
CR4030-470M	47	20	500	0.90	0.72	100kHz /0.25V	470
CR4030-560M	56	20	560	0.85	0.65	100kHz /0.25V	560
CR4030-680M	68	20	750	0.75	0.55	100kHz /0.25V	680
CR4030-820M	82	20	950	0.68	0.50	100kHz /0.25V	820
CR4030-101M	100	20	1150	0.60	0.45	100kHz /0.25V	101
CR4030-151M	150	20	2350	0.50	0.35	100kHz /0.25V	151
CR4030-181M	180	20	2500	0.40	0.35	100kHz /0.25V	181
CR4030-221M	220	20	3000	0.40	0.30	100kHz /0.25V	221
CR4030-331M	330	20	4400	0.30	0.23	100kHz /0.25V	331
CR4030-471M	470	20	5500	0.30	0.20	100kHz /0.25V	471

Isat (A) : DC Saturation Current that will cause initial inductance to drop approximately 30% max.

Irise((A)):DC Current that will cause an approximate ΔT of 40 °C

Measuring Instrument :

L:HIOKI3532-50

DCR:HIOKI 3540

I sat / Irise:HP4284+42841A

3. General Characteristics

3-1. Storage Temperature range : $-40^{\circ}\text{C} \sim +105^{\circ}\text{C}$

3-2. Operating temperature range: $-40^{\circ}\text{C} \sim +125^{\circ}\text{C}$ (Including coil's self temperature rise)

3-3. External appearance : No external defects can be found in the visual inspection.

3-4. Electrode strength : No electrode detachment should be found when the device is pushed in two directions of X and Y with the force of 10.0N for 10 ± 2 seconds after soldering between copper plate and the electrodes.
(Refer to figure at right)

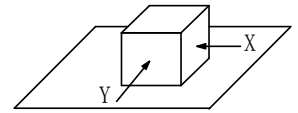

3-5. Vibration test : Inductance deviation is within $\pm 10.0\%$ after 1 hour sweeping vibration in each three directions, namely, forward and backward, up and down, right and left. The frequency is $10 \sim 55 \sim 10\text{Hz}$ and the amplitude of 1 minute cycle is 1.5mm PP.

3-6. Recommended reflow condition:

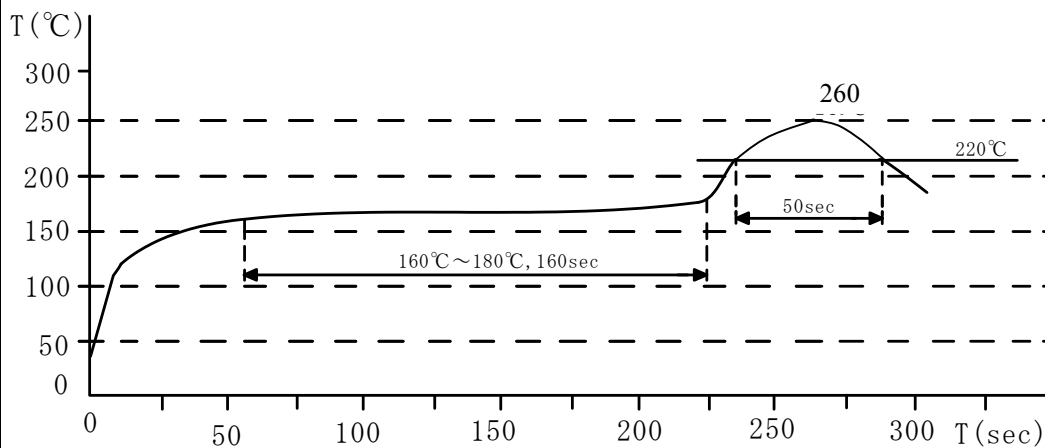

3-7. Humidity test : Inductance deviation is within $\pm 5.0\%$ after 96 ± 4 hours test under the condition of relative humidity of $90 \sim 95\%$ and temperature of $60 \pm 2^{\circ}\text{C}$, and 1 hour storage under room ambient conditions after the device is wiped with dry cloth.

LEAD-FREE

RoHS
Compliance

4. Construction and materials

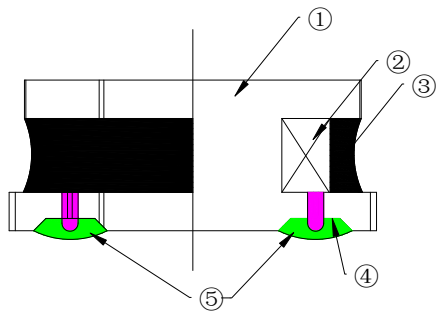

No.	Part name	Material	Ceaiya P/N
①	Drum Core	Ni-Zn Ferrite Core	YN/MT
②	Wire	Polyurethane enameled copper wire	3210200
③	Adhesive	Epoxy Resin Magnetic Powder	7001007
④	Plating Electrodes	Plating: Ag 10-20 μm Ni 1-3 μm Sn 3-7 μm	
⑤	Outer Electrodes	Top surface solder coating Sn99%、Ag0.3%、Cu0.7%	YX

5. Packaging and Marking:

5-1. Carrier Tape Dimensions:

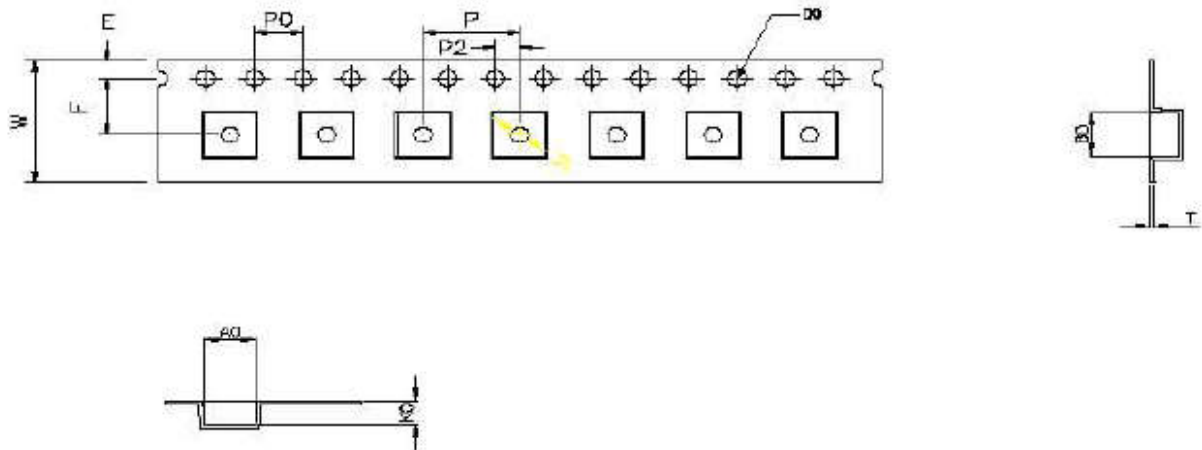

ITEM	W	A0	B0	K0	P	F	E	D0	D1	P0	P2	T
DIM	12.00	4.5	4.5	3.2	8.00	5.50	1.75	1.50	1.50	4.00	2.00	0.30
TOLE	+0.30 -0.10	± 0.1	± 0.1	± 0.1	± 0.1	± 0.1	± 0.1	+0.1	+0.1	± 0.1	± 0.1	± 0.05

5-2. Taping Dimensions:

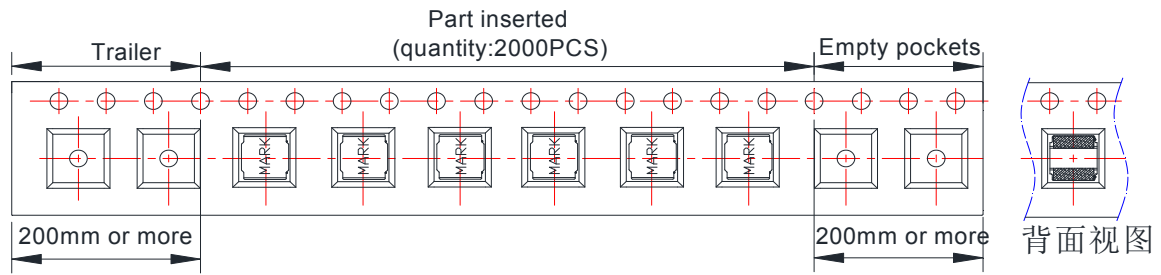

5-3. Reel Dimensions:

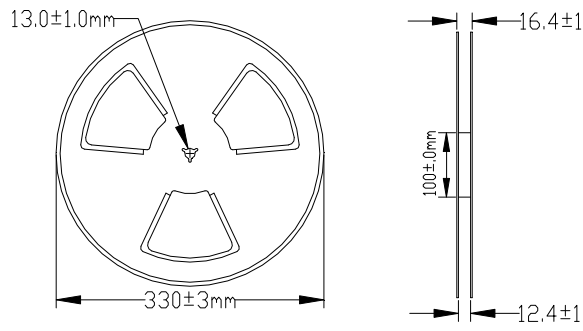

6. PACKAGE SPECIFICATION:

2KPCS/ Reel 6KPCS/ Inner Box 18KPCS/ Outer Box

编带方向，如下图所示

编带时，卷带前后各留空 20cm 最小

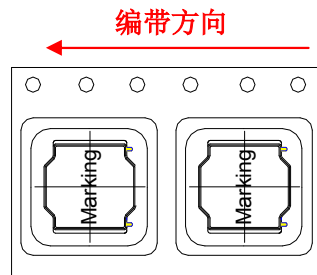

Visual Inspection Standard of Product

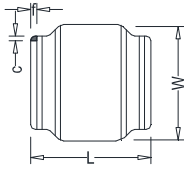
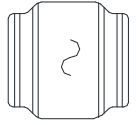
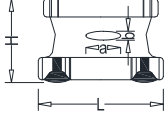
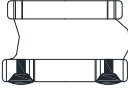
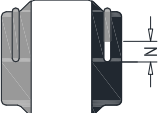
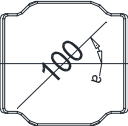
No.	Defect Item	Figure	Rejection Identification	Acceptance
1	Core Defect		The defect length(c or f)more than L/6 or W/6 , NG	AQL=0.65
2	Core Crack		Visual cracks , NG	AQL=0.65
3	Starvation		(1)Resin starved length a more than L/2, NG (2)When $L > 2\text{mm}$, $b > H/2$, NG (3)When $L \leq 2\text{mm}$, b don't control	AQL=0.65
4	Excessive glue		The length, width or height of product beyond specified value, NG	AQL=0.65
5	Cold Solder		(1)For CR2520** Series , cold solder $N > 0.5\text{mm}$,NG (2)For other series, cold solder $N > 1\text{mm}$,NG	AQL=0.65
6	Marking Defect		The marking angle $a > 45^\circ$, NG	AQL=0.65

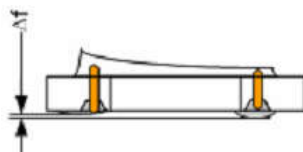

Δf : Clearance between terminal and the surface of plate must be 0.15mm max when coil is placed on a flat plate.