

SE6080A

N-Channel Enhancement-Mode MOSFET

Revision: A

General Description

This type used advanced trench technology and design to provide excellent $R_{DS(ON)}$ with low gate charge.

- High density cell design for ultra low $R_{DS(ON)}$
- Excellent package for good heat dissipation

Features

For a single MOSFET

- $V_{DS} = 60V$
- $R_{DS(ON)} = 6.5m\Omega @ V_{GS}=10V$
-

Pin configurations

See Diagram below

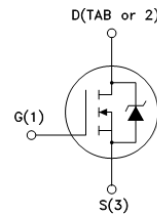
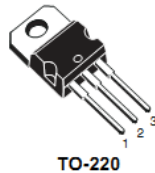

Absolute Maximum Ratings

Parameter		Symbol	Rating	Units
Drain-Source Voltage		V_{DS}	60	V
Gate-Source Voltage		V_{GS}	± 20	V
Drain Current	Continuous	I_D	80	A
	Pulsed		220	
Total Power Dissipation	@TA=25°C	P_D	110	W
Operating Junction Temperature Range		T_J	-55 to 175	°C

SE6080A

Electrical Characteristics (T _J =25°C unless otherwise noted)						
Symbol	Parameter	Test Conditions	Min	Typ	Max	Units
OFF CHARACTERISTICS (Note 2)						
B _V DSS	Drain-Source Breakdown Voltage	I _D =250μA, V _{GS} =0 V	60			V
I _{DSS}	Drain to Source Leakage Current	V _{DS} = 48V, V _{GS} =0V			1	μA
I _{GSS}	Gate-Body Leakage Current	V _{GS} =20V			100	nA
V _{GS(th)}	Gate Threshold Voltage	V _{DS} = V _{GS} , I _D =250μA	2		4	V
R _{DS(ON)}	Static Drain-Source On-Resistance	V _{GS} =10V, I _D =40A		6.5	7.5	mΩ
DYNAMIC PARAMETERS						
C _{iss}	Input Capacitance	V _{GS} =0V, V _{DS} =40V, f=1MHz		7765		pF
C _{oss}	Output Capacitance			960		pF
C _{rss}	Reverse Transfer Capacitance			66		pF
SWITCHING PARAMETERS						
Q _g	Total Gate Charge ²	V _{GS} =10V, V _{DS} =40V, I _D =20A		127	178	nC
Q _{gs}	Gate Source Charge			58		nC
Q _{gd}	Gate Drain Charge			35		nC
t _{d(on)}	Turn-On Delay Time	V _{GS} =10V, V _{DS} =40V, R _{GEN} =3Ω		24		ns
t _{d(off)}	Turn-Off Delay Time			55		ns
t _{d(r)}	Turn-On Rise Time			18		ns
t _{d(f)}	Turn-Off Fall Time			17		ns
Thermal Resistance						
Symbol	Parameter	Min	Typ	Units		
R _{θJC}	Junction to Case	0.35	0.55	°C/W		

Test Circuit

Gate Charge Test Circuit & Waveform

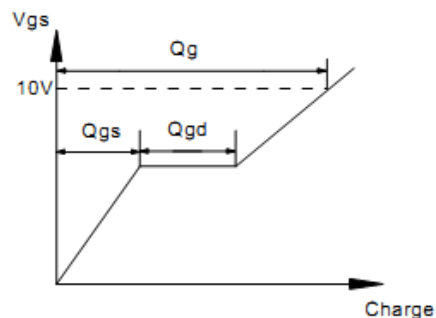
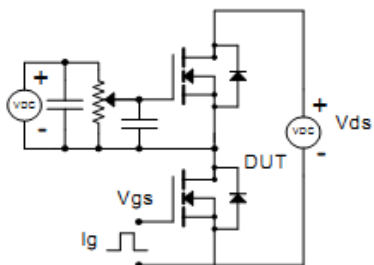

Resistive Switching Test Circuit & Waveforms

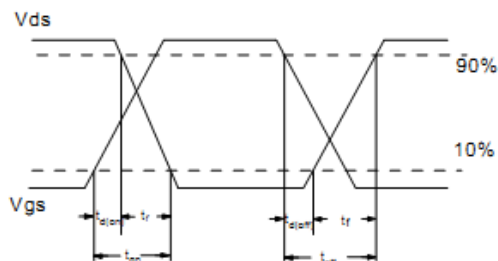
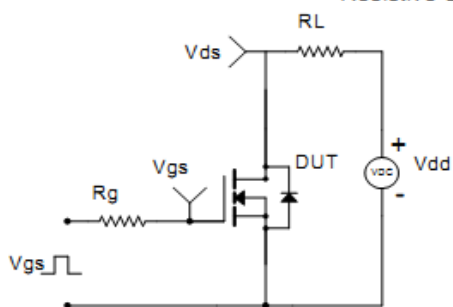

Unclamped Inductive Switching (UIS) Test Circuit & Waveforms

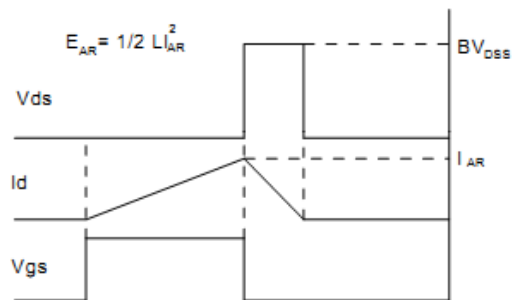
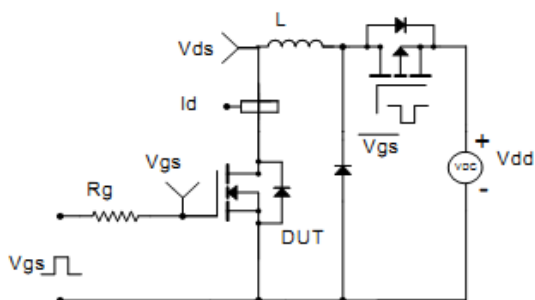

Diode Recovery Test Circuit & Waveforms

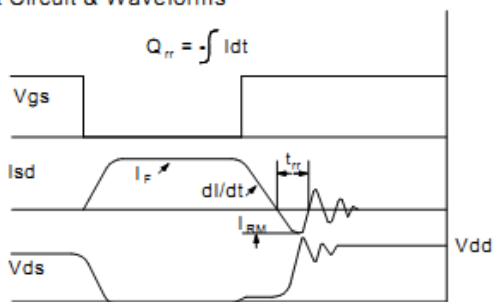
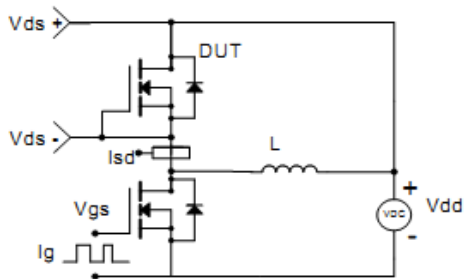

Typical Characteristics

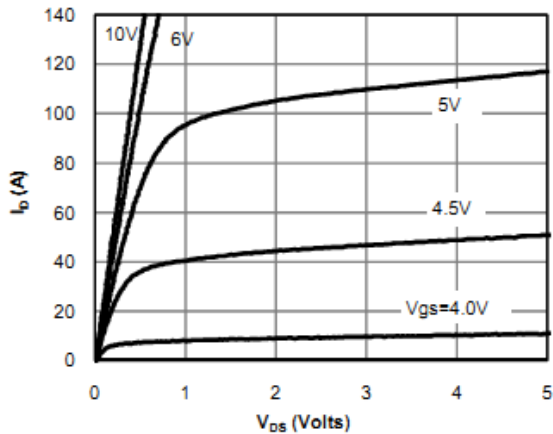

Fig 1: On-Region Characteristics (Note E)

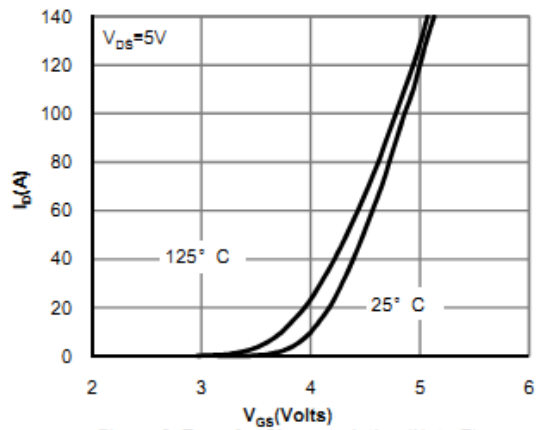

Figure 2: Transfer Characteristics (Note E)

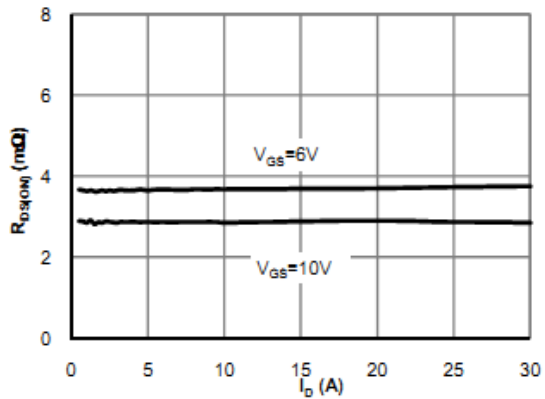

Figure 3: On-Resistance vs. Drain Current and Gate Voltage (Note E)

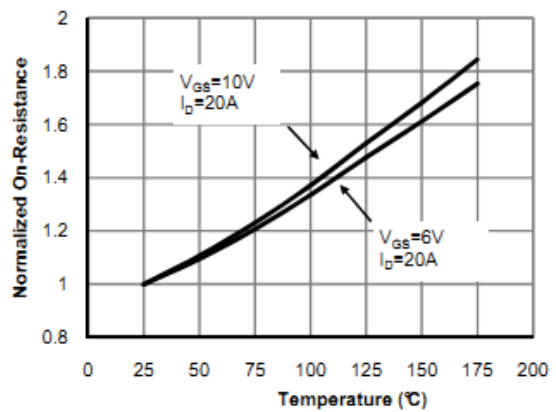

Figure 4: On-Resistance vs. Junction Temperature (Note E)

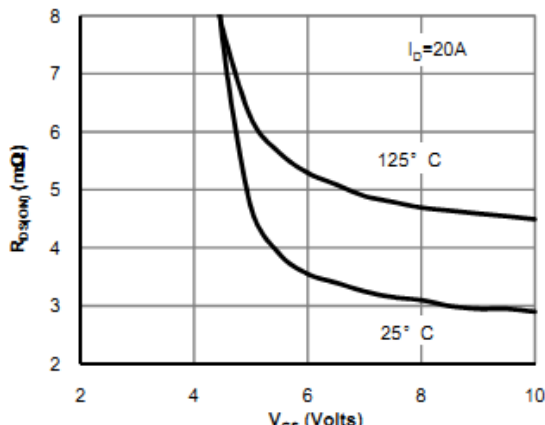

Figure 5: On-Resistance vs. Gate-Source Voltage (Note E)

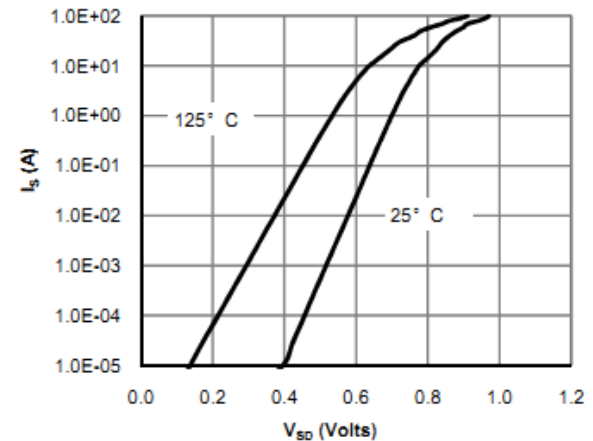

Figure 6: Body-Diode Characteristics (Note E)

Typical Characteristics

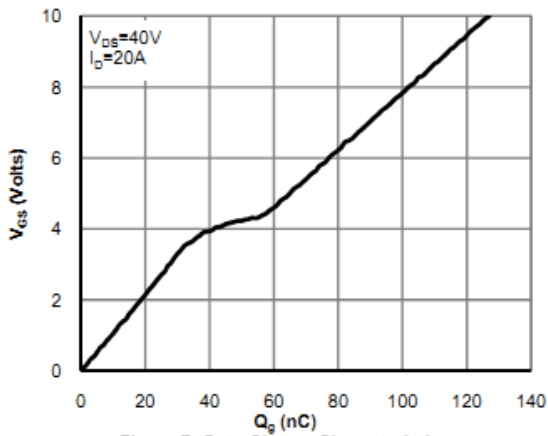

Figure 7: Gate-Charge Characteristics

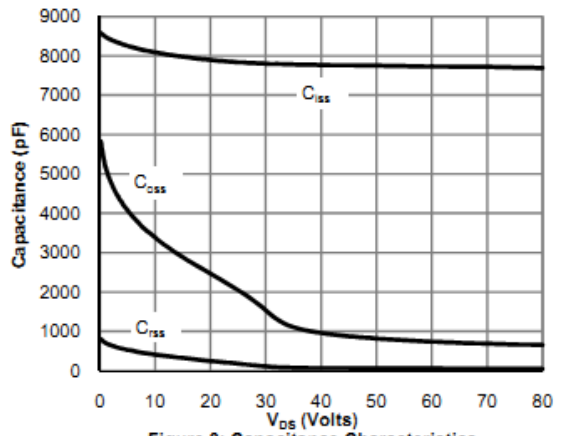

Figure 8: Capacitance Characteristics

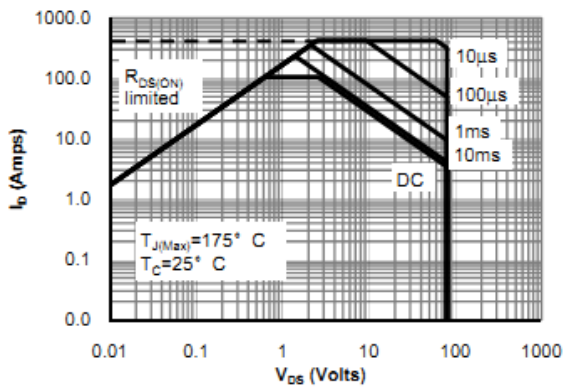

Figure 9: Maximum Forward Biased Safe Operating Area (Note F)

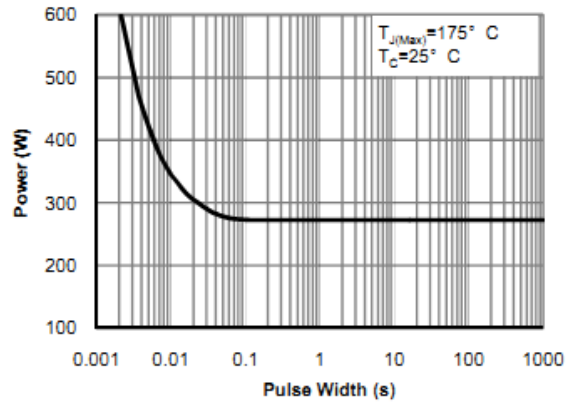

Figure 10: Single Pulse Power Rating Junction-to-Case (Note F)

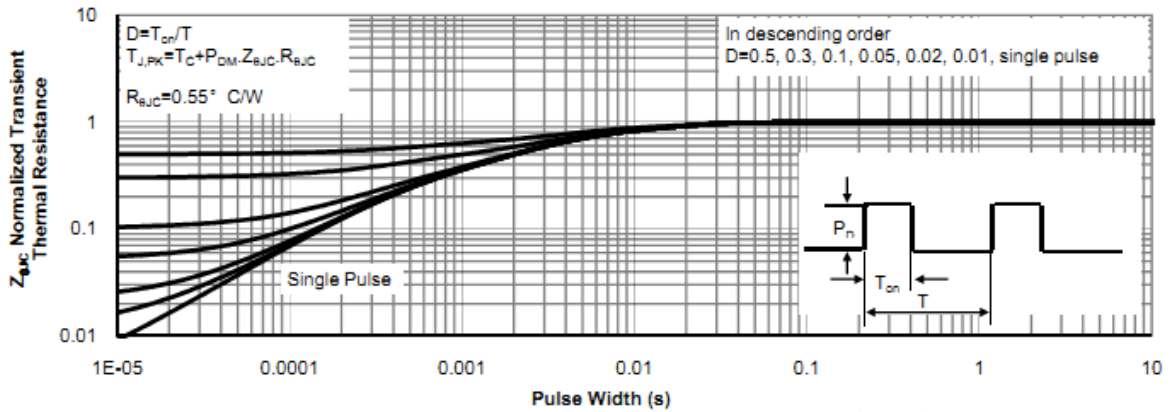

Figure 11: Normalized Maximum Transient Thermal Impedance (Note F)

Typical Characteristics

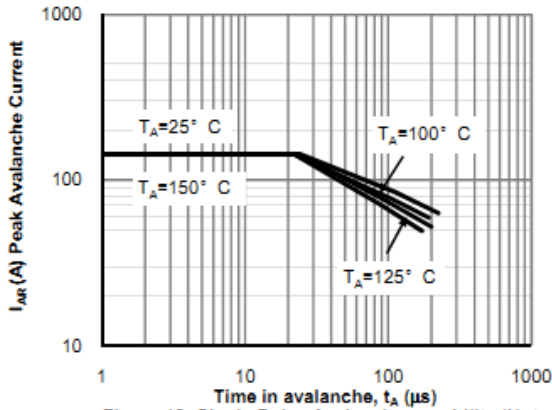

Figure 12: Single Pulse Avalanche capability (Note C)

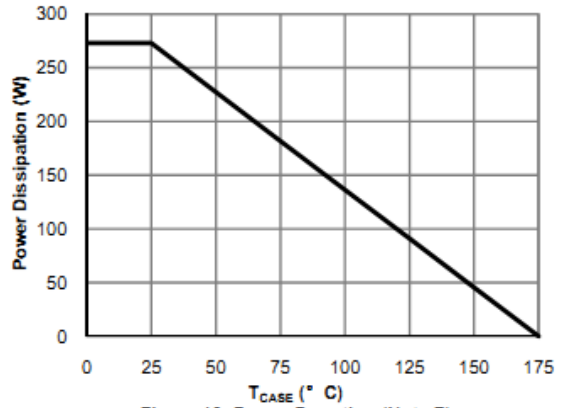

Figure 13: Power De-rating (Note F)

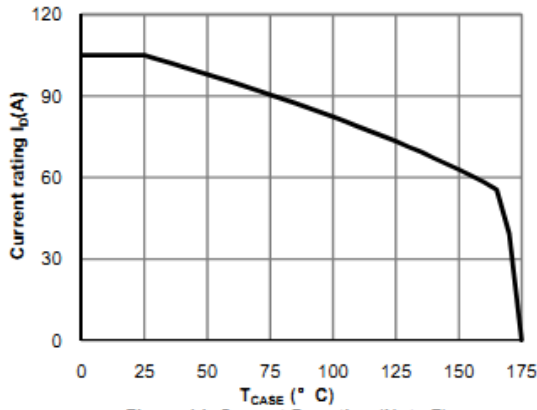

Figure 14: Current De-rating (Note F)

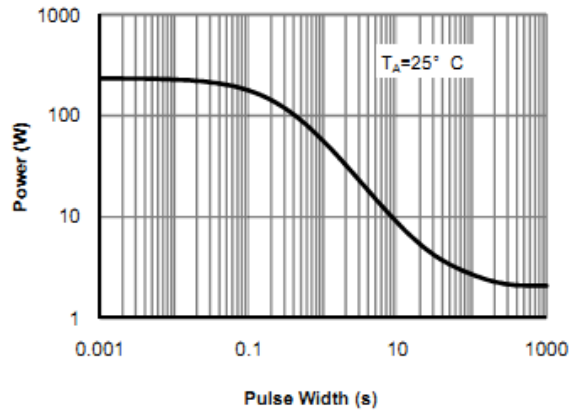

Figure 15: Single Pulse Power Rating Junction-to-Ambient (Note H)

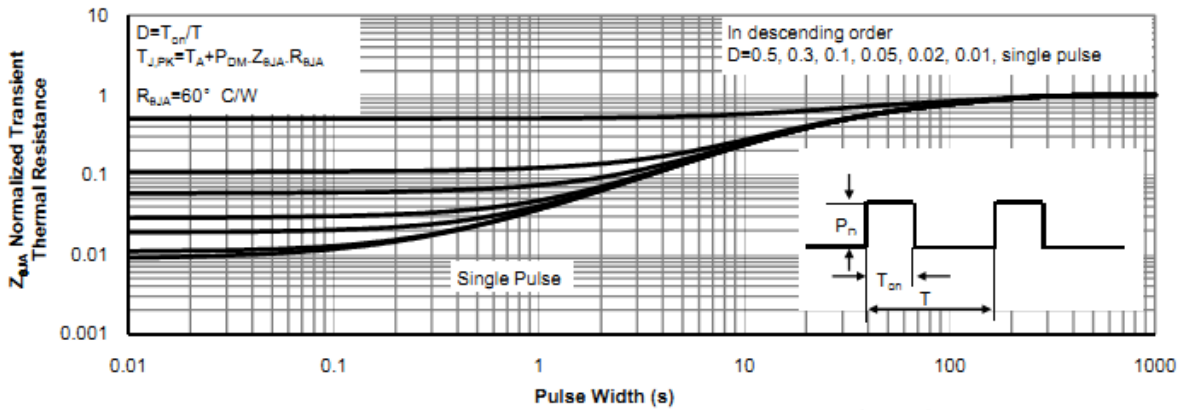
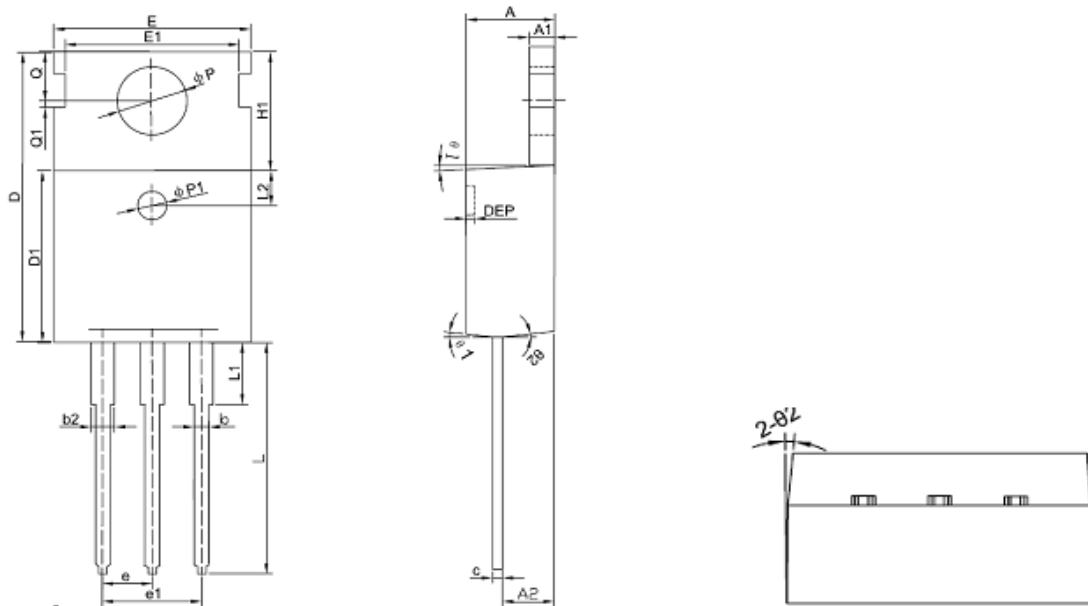

Figure 16: Normalized Maximum Transient Thermal Impedance (Note H)

SE6080A

Package Outline Dimension

TO-220



Symbol	Dimension In Millimeters			Dimension In Inches		
	Min	Nom	Max	Min	Nom	Max
A	4.400	4.550	4.700	0.173	0.179	0.185
A1	1.270	1.300	1.330	0.050	0.051	0.052
A2	2.590	2.690	2.790	0.102	0.106	0.110
b	0.770	-	0.900	0.030	-	0.035
b2	1.230	-	1.360	0.048	-	0.054
c	0.480	0.500	0.520	0.019	0.020	0.020
D	15.100	15.400	15.700	-	0.606	-
D1	9.000	9.100	9.200	0.354	0.358	0.362
DEP	0.050	0.285	0.520	0.002	0.011	0.020
E	10.060	10.160	10.260	0.396	0.400	0.404
E1	-	8.700	-	-	0.343	-
ΦP1	1.400	1.500	1.600	0.055	0.059	0.063
e	2.54BSC			0.1BSC		
e1	5.08BSC			0.2BSC		
H1	6.100	6.300	6.500	0.240	0.248	0.256
L	12.750	12.960	13.170	0.502	0.510	0.519
L1	-	-	3.950	-	-	0.156
L2	1.85REF			0.073REF		
ΦP	3.570	3.600	3.630	0.141	0.142	0.143
Q	2.730	2.800	2.870	0.107	0.110	0.113
Q1	-	0.200	-	-	0.008	-
Θ1	5 ⁰	7 ⁰	9 ⁰	5 ⁰	7 ⁰	9 ⁰
Θ2	1 ⁰	3 ⁰	5 ⁰	1 ⁰	3 ⁰	5 ⁰

The SINO-IC logo is a registered trademark of ShangHai Sino-IC Microelectronics Co., Ltd.

© 2005 SINO-IC - Printed in China - All rights reserved.

SHANGHAI SINO-IC MICROELECTRONICS CO., LTD

Add: Building 3, Room 3401-03, No.200 Zhangheng Road,
ZhangJiang Hi-Tech Park, Pudong, Shanghai 201203, China

Phone: +86-21-33932402 33932403

33932405 33933508 33933608

Fax: +86-21-33932401

Email: szrxw002@126.com

Website: <http://www.sino-ic.net>