

SE12N65F

N-Channel Enhancement-Mode MOSFET

Revision: A

General Description

Thigh Density Cell Design For Ultra Low On-Resistance Fully Characterized Avalanche Voltage and Current Improved Shoot-Through FOM

- Simple Drive Requirement
- Small Package Outline
- Surface Mount Device

Features

For a single MOSFET

- $V_{DS} = 650V$
- $R_{DS(ON)} = 330m\Omega @ V_{GS}=10V$

Pin configurations

See Diagram below

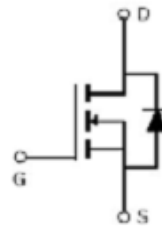

Absolute Maximum Ratings

Parameter		Symbol	Rating	Units
Drain-Source Voltage		V_{DS}	650	V
Gate-Source Voltage		V_{GS}	± 30	V
Drain Current	Continuous	I_D	12	A
	Pulsed		28	
Single Pulse Avalanche Engergy		E_{AS}	226	mJ
Total Power Dissipation	@TA=25°C	P_D	156	W
Operating Junction Temperature Range		T_J	-55 to 150	°C

SE12N65F

Electrical Characteristics (T _J =25°C unless otherwise noted)						
Symbol	Parameter	Test Conditions	Min	Typ	Max	Units
OFF CHARACTERISTICS (Note 2)						
B _V DSS	Drain-Source Breakdown Voltage	I _D =250μA, V _{GS} =0 V	650			V
I _{DSS}	Drain to Source Leakage Current	V _{DS} = 650V, V _{GS} =0V			1	μA
I _{GSS}	Gate-Body Leakage Current	V _{GS} =20 V			100	nA
V _{GS(th)}	Gate Threshold Voltage	V _{DS} = V _{GS} , I _D =250μA	2		4	V
R _{DS(ON)}	Static Drain-Source On-Resistance ²	V _{GS} =10V, I _D =6A		330	380	mΩ
g _{fs}	Forward Transconductance	V _{DS} =30V, I _D =6A		3.5		S
DYNAMIC PARAMETERS						
C _{iss}	Input Capacitance	V _{GS} =0V, V _{DS} =100V, f=1MHz		1224		pF
C _{oss}	Output Capacitance			65		pF
C _{rss}	Reverse Transfer Capacitance			4		pF
SWITCHING PARAMETERS						
Q _g	Total Gate Charge ²	V _{GS} =10V, V _{DS} =520V, I _D =6A		35	70	nC
Q _{gs}	Gate Source Charge			9		nC
Q _{gd}	Gate Drain Charge			16		nC
t _{d(on)}	Turn-On Delay Time	V _{GS} =10V, V _{DS} =520V, R _{GEN} =9.1Ω I _D =6A		16	32	ns
t _{d(off)}	Turn-Off Delay Time			35	70	ns
t _{d(r)}	Turn-On Rise Time			19	38	ns
t _{d(f)}	Turn-Off Fall Time			18	36	ns
Thermal Resistance						
Symbol	Parameter		Typ	Max		Units
R _{θJC}	Junction to Case		-	0.8		°C/W
R _{θJA}	Junction to Ambient (t ≤ 10s)		-	62		°C/W

Typical Characteristics

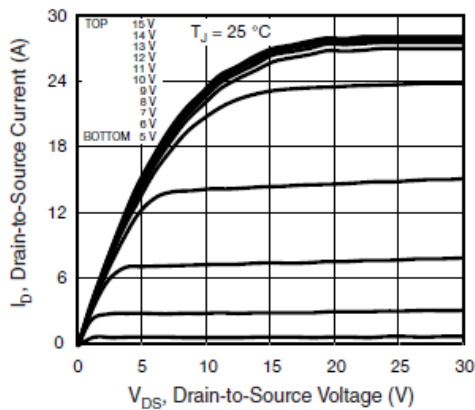

Fig. 1 - Typical Output Characteristics

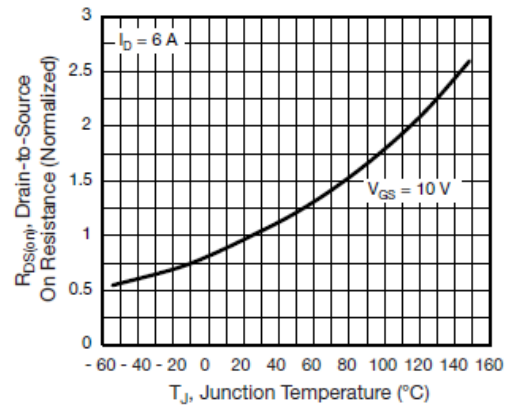

Fig. 4 - Normalized On-Resistance vs. Temperature

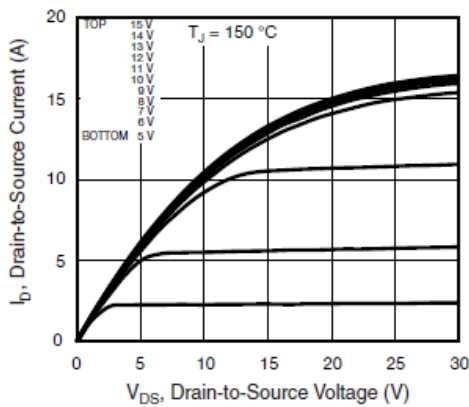

Fig. 2 - Typical Output Characteristics

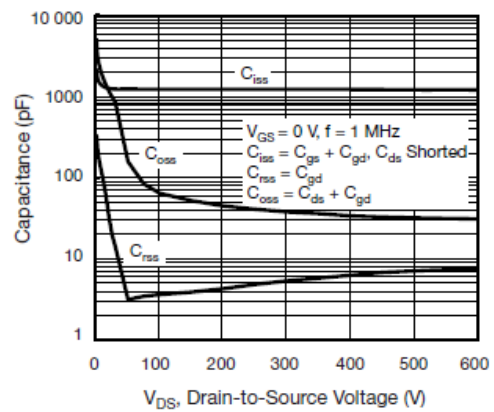

Fig. 5 - Typical Capacitance vs. Drain-to-Source Voltage

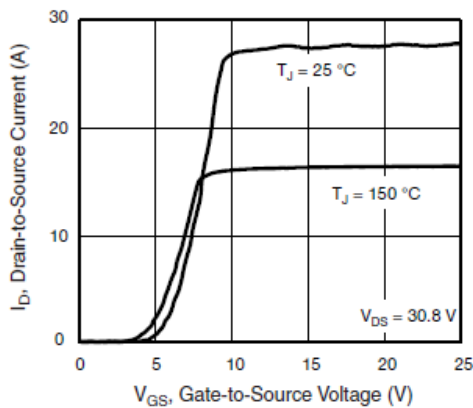

Fig. 3 - Typical Transfer Characteristics

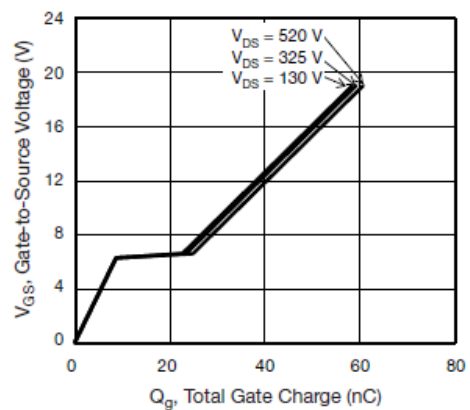

Fig. 6 - Typical Gate Charge vs. Gate-to-Source Voltage

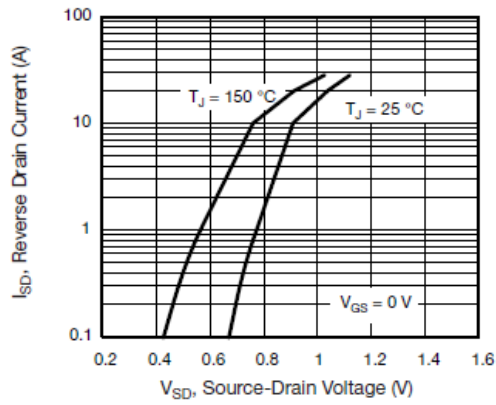

Fig. 7 - Typical Source-Drain Diode Forward Voltage

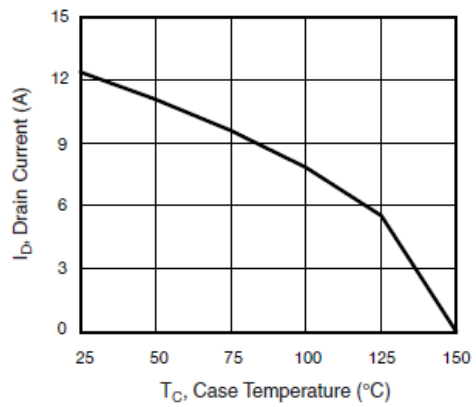

Fig. 9 - Maximum Drain Current vs. Case Temperature

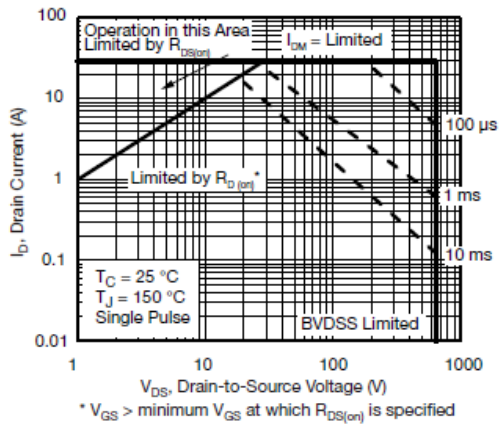

Fig. 8 - Maximum Safe Operating Area

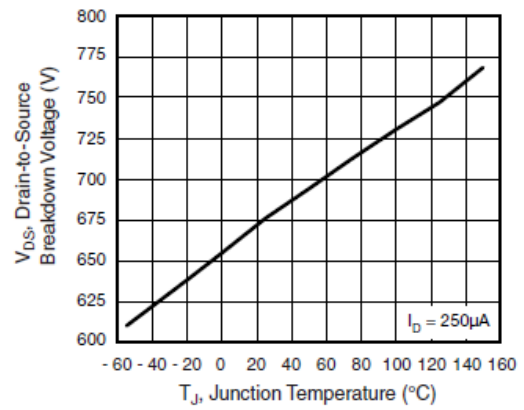

Fig. 10 - Temperature vs. Drain-to-Source Voltage

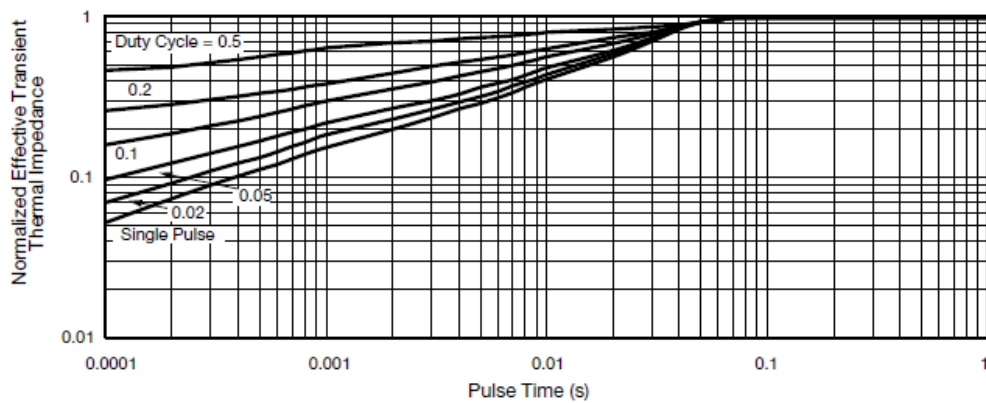
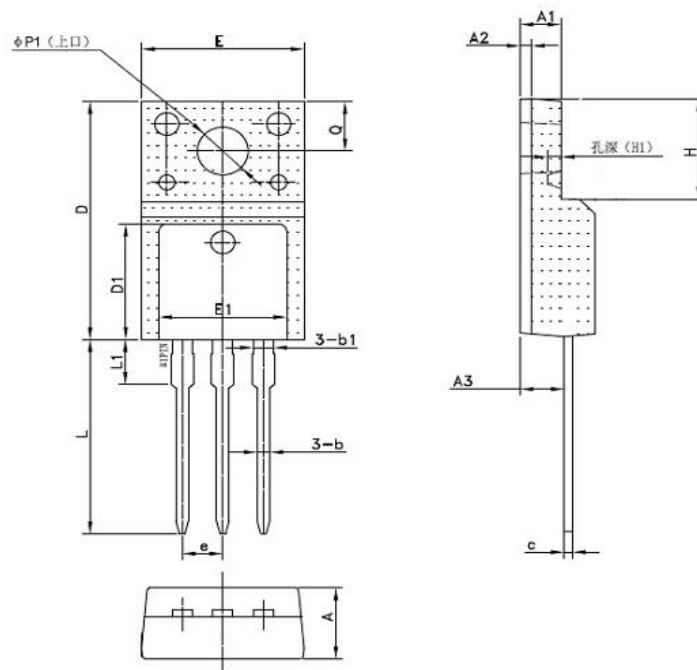

Fig. 11 - Normalized Thermal Transient Impedance, Junction-to-Case

SE12N65F

Package Outline Dimension

TO-220F



Symbol	Dimension In Millimeters			Dimension In Inches		
	Min	Nom	Max	Min	Nom	Max
A	4.400	4.550	4.700	0.173	0.179	0.185
A1	1.270	1.300	1.330	0.050	0.051	0.052
A2	2.590	2.690	2.790	0.102	0.106	0.110
b	0.770	-	0.900	0.030	-	0.035
b2	1.230	-	1.360	0.048	-	0.054
c	0.480	0.500	0.520	0.019	0.020	0.020
D	15.100	15.400	15.700	-	0.606	-
D1	9.000	9.100	9.200	0.354	0.358	0.362
DEP	0.050	0.285	0.520	0.002	0.011	0.020
E	10.060	10.160	10.260	0.396	0.400	0.404
E1	-	8.700	-	-	0.343	-
$\Phi P1$	1.400	1.500	1.600	0.055	0.059	0.063
e	2.54BSC			0.1BSC		
e1	5.08BSC			0.2BSC		
H1	6.100	6.300	6.500	0.240	0.248	0.256
L	12.750	12.960	13.170	0.502	0.510	0.519
L1	-	-	3.950	-	-	0.156
L2	1.85REF			0.073REF		
ΦP	3.570	3.600	3.630	0.141	0.142	0.143
Q	2.730	2.800	2.870	0.107	0.110	0.113
Q1	-	0.200	-	-	0.008	-
$\theta 1$	5 ⁰	7 ⁰	9 ⁰	5 ⁰	7 ⁰	9 ⁰
$\theta 2$	1 ⁰	3 ⁰	5 ⁰	1 ⁰	3 ⁰	5 ⁰

SE12N65F

The SINO-IC logo is a registered trademark of ShangHai Sino-IC Microelectronics Co., Ltd.

© 2005 SINO-IC - Printed in China - All rights reserved.

SHANGHAI SINO-IC MICROELECTRONICS CO., LTD

Add: Building 3, Room 3401-03, No.200 Zhangheng Road,
ZhangJiang Hi-Tech Park, Pudong, Shanghai 201203, China

Phone: +86-21-33932402 33932403

33932405 33933508 33933608

Fax: +86-21-33932401

Email: szrxw002@126.com

Website: <http://www.sino-ic.net>