



Features

- ✧ V_{BO} : 32V
- ✧ Breakover voltage range: 28 to 36V

Applications

Functioning as a trigger diode with a fixed voltage reference, the DB3 can be used in conjunction with triacs for simplified gate control circuits or as a starting element in fluorescent lamp ballasts.

DO-35

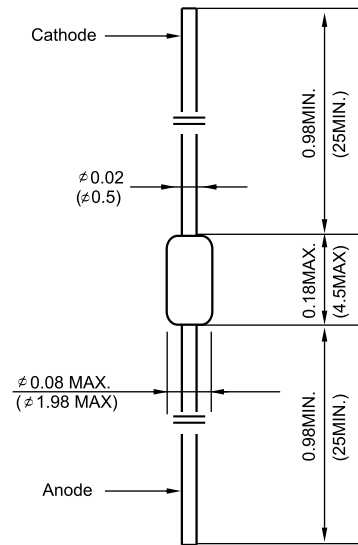

Dimensions in inches and (millimeters)

Absolute Maximum Ratings

(Limiting values)

Parameter	Symbol	Value	Unit
Repetitive peak on-state current ($t_p=20 \mu s$ $F=120$ Hz)	I_{TRM}	2	A
Operating junction temperature range	T_j	-40 ~ +125	$^{\circ}C$
Storage temperature range	T_{stg}	-40 ~ +125	$^{\circ}C$

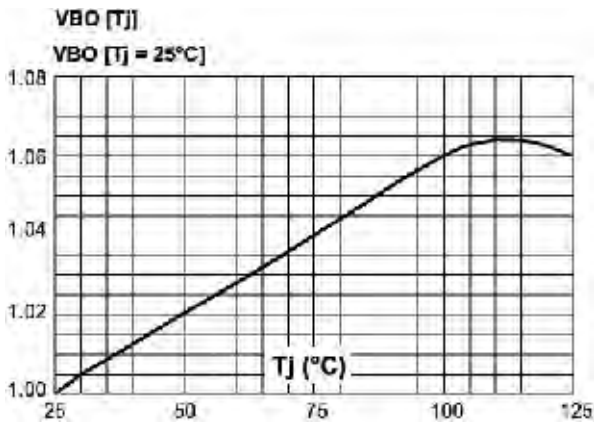

Figure 1. Relative variation of VBO versus junction temperature (typical values)

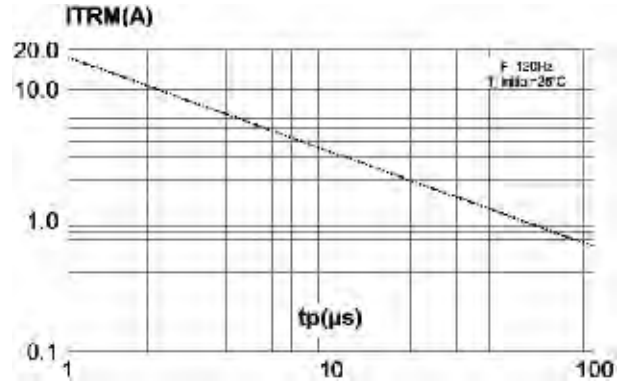

Figure 2. Repetitive peak pulse current versus Pulse duration (maximum values)

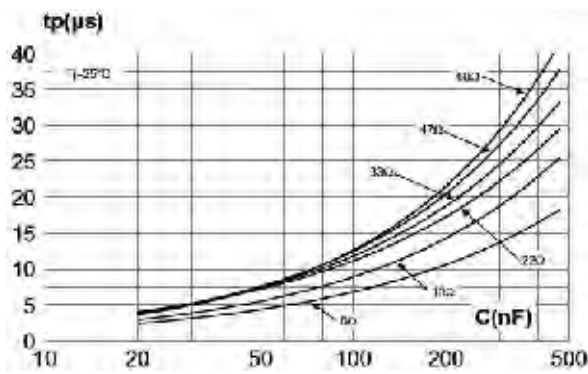

Figure 3. Time duration while current pulse is higher 50 mA versus C and Rs (typical values)

Electrical Characteristics

($T_j=25^\circ\text{C}$ unless otherwise specified)

Parameter	Symbol	Test Conditions	Value	Unit	
Breakover voltage*	V_{BO}	$C=22\text{nF}^{**}$	MIN.	28	V
			TYP.	32	
			MAX.	36	
Breakover voltage symmetry	$ V_{BO1}-V_{BO2} $	$C=22\text{nF}^{**}$	MAX.	± 3	V
Dynamic breakover voltage*	ΔV	V_{BO} and V_F at 10mA	MIN.	5	V
Output voltage*	V_O	see diagram 2($R=20\ \Omega$)	MIN.	5	V
Breakover current*	I_{BO}	$C=22\text{nF}^{**}$	MAX.	50	μA
Rise time*	t_r	see diagram 3	MAX.	2	μs
Leakage current*	I_R	$V_R=0.5V_{BO}$ max	MAX.	10	μA

*Applicable to both forward and reverse directions.

**Connected in parallel to the device.

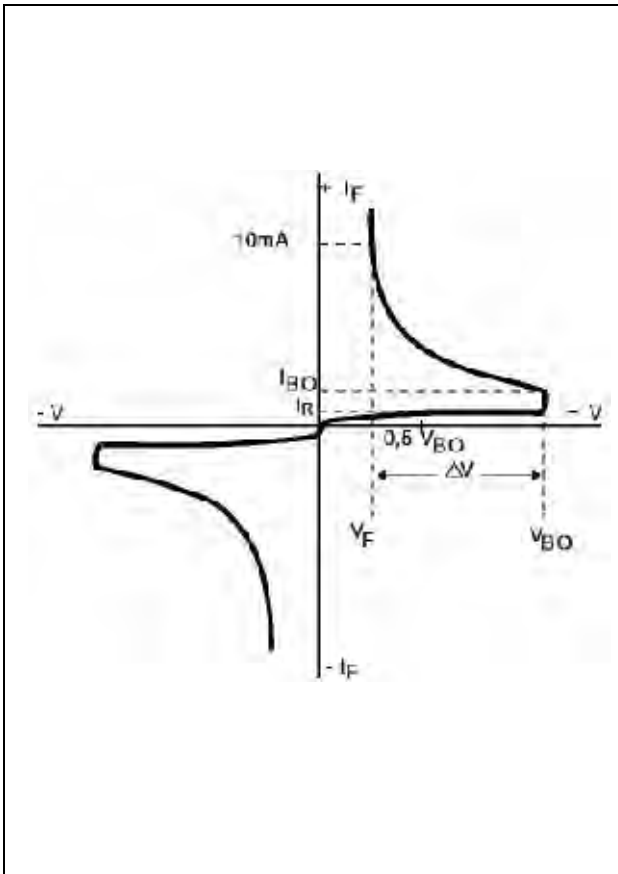

Diagram 1. Voltage – current characteristic curve

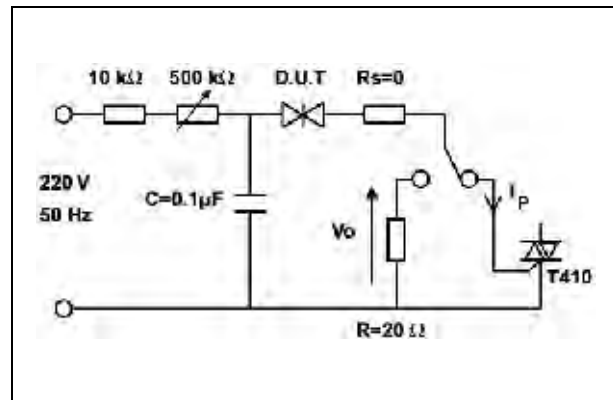

Diagram 2. Test circuit

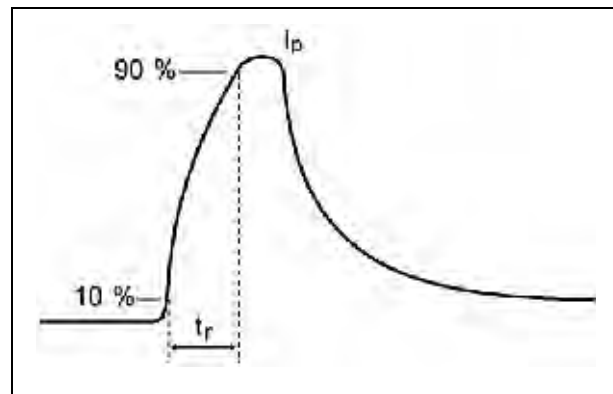

Diagram 3. Rise time measurement