

DESCRIPTION:

With low holding and latching current, BT131 Series triacs are especially recommended for use on middle and small resistance type power load.

MAIN FEATURES:

symbol	value	unit
$I_{T(RMS)}$	1	A
V_{DRM}/V_{RRM}	600/800	V
V_{TM}	≤ 1.5	V

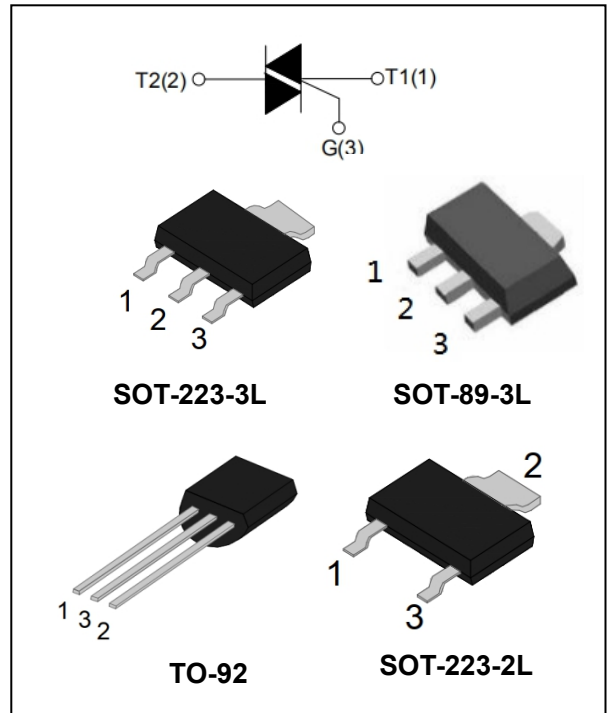

ABSOLUTE MAXIMUM RATINGS:

Parameter		Symbol	Value	Unit
Storage junction temperature range		T_{stg}	-40~150	$^{\circ}C$
Operating junction temperature range		T_j	-40~125	$^{\circ}C$
Repetitive peak off-state voltage ($T_j=25^{\circ}C$)		V_{DRM}	600/800	V
Repetitive peak reverse voltage ($T_j=25^{\circ}C$)		V_{RRM}	600/800	V
RMS on-state current		$I_{T(RMS)}$	1	A
Non repetitive surge peak on-state current (full cycle, $F=50Hz$)		I_{TSM}	16	A
I^2t value for fusing ($t_p=10ms$)		I^2t	1.28	A^2s
Critical rate of rise of on-state current ($I_G=2 \times I_{GT}$)	di/dt	I - II - III	50	A/ μs
		IV	10	
Peak gate current		I_{GM}	2	A
Average gate power dissipation		$P_{G(AV)}$	0.5	W
Peak gate power		P_{GM}	5	W

ELECTRICAL CHARACTERISTICS ($T_j=25^\circ\text{C}$ unless otherwise specified)

Parameter	Test Condition	Quadrant	Value		Unit	
			T	D		
I_{GT}	$V_D=12\text{V}, R_L=33\Omega$	I - II - III	MAX	3	5	mA
		IV		5	10	
V_{GT}		I - II - III - IV		1.3		V
V_{GD}	$V_D=V_{DRM}$	I - II - III - IV	MIN	0.2		V
I_H	$I_T=100\text{mA}$		MAX	5	7	mA
I_L	$I_G=1.2I_{GT}$	I - III - IV	MAX	5	5	
		II		10	20	
dV/dt	$V_D=0.66 \times V_{DRM}$ $T_j=125^\circ\text{C}$ Gate open		MIN	20	50	V/ μs

STATIC CHARACTERISTICS

Symbol	Test Condition			Value	Unit
V_{TM}	$I_{TM}=1.4\text{A}$ $t_p=380\mu\text{s}$	$T_j=25^\circ\text{C}$	MAX	1.5	V
I_{DRM} I_{RRM}	$V_{DRM}=V_{RRM}$	$T_j=25^\circ\text{C}$	MAX	5	μA
		$T_j=125^\circ\text{C}$		0.5	mA

THERMAL RESISTANCES

Symbol	Test Condition		Value	Unit
$R_{th(j-c)}$	junction to case(AC)	TO-92	60	$^\circ\text{C}/\text{W}$
		SOT-89/SOT-223 SOT-223-2L	31	$^\circ\text{C}/\text{W}$

ORDERING INFORMATION

BT Triacs	131-600 $I_{T(RMS)}: 1A$	V_{DRM}, V_{RRM} : 600: 600V 800: 800V	D T: $I_{GT1-3} \leq 3mA, I_{GT4} \leq 5mA$ D: $I_{GT1-3} \leq 5mA, I_{GT4} \leq 10mA$
---------------------	------------------------------------	--	---

PACKAGE MECHANICAL DATA

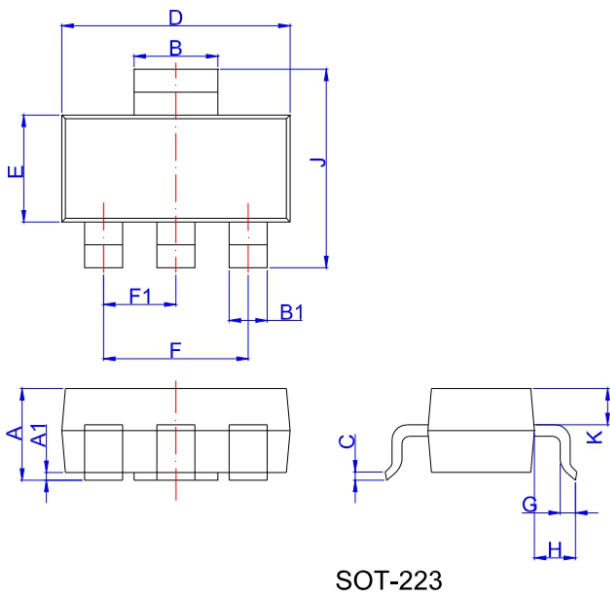

Ref.	Dimensions					
	Millimeters			Inches		
	Min.	Typ.	Max.	Min.	Typ.	Max.
A	1.5	1.6	1.8	0.059	0.063	0.071
A1	0.01	0.06	0.10	0.001	0.002	0.004
B	2.9	3.0	3.1	0.114	0.118	0.122
B1	0.6	0.7	0.8	0.024	0.028	0.031
C	0.22	0.25	0.32	0.009	0.010	0.013
D	6.3	6.5	6.7	0.248	0.256	0.264
E	3.3	3.5	3.7	0.130	0.138	0.146
F		4.6	6.8	0.252	0.181	
F1		2.3			0.091	
G	0.7	0.9	1.1	0.028	0.035	0.043
H	1.5	1.75	2.0	0.059	0.069	0.079
J	6.7	7.0	7.3	0.264	0.276	0.287
K	0.8	0.9	1.0	0.031	0.035	0.039

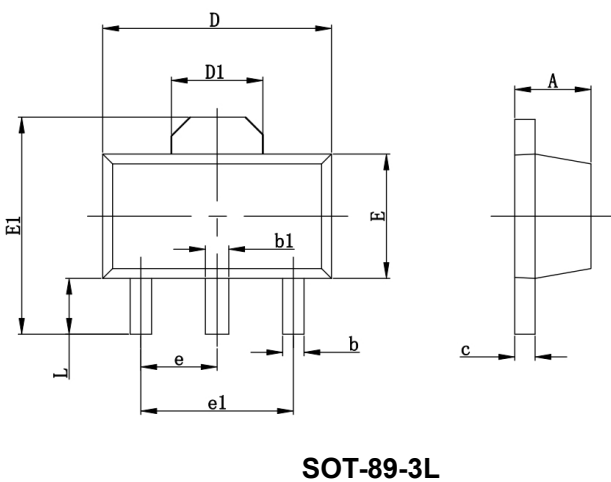

Ref.	Dimensions					
	Millimeters			Inches		
	Min.	Typ.	Max.	Min.	Typ.	Max.
A	1.4		1.6	0.055		0.063
b	0.35		0.52	0.013		0.197
b1	0.4		0.58	0.016		0.023
c	0.35		0.44	0.014		0.017
D	4.4		4.6	0.173		0.181
D1		1.55			0.061	
E	2.35		2.55	0.091		0.102
E1	3.94		4.25	0.155		0.167
e		1.500			0.060	
e1		3.000			0.118	
L	0.9		1.1	0.035		0.047

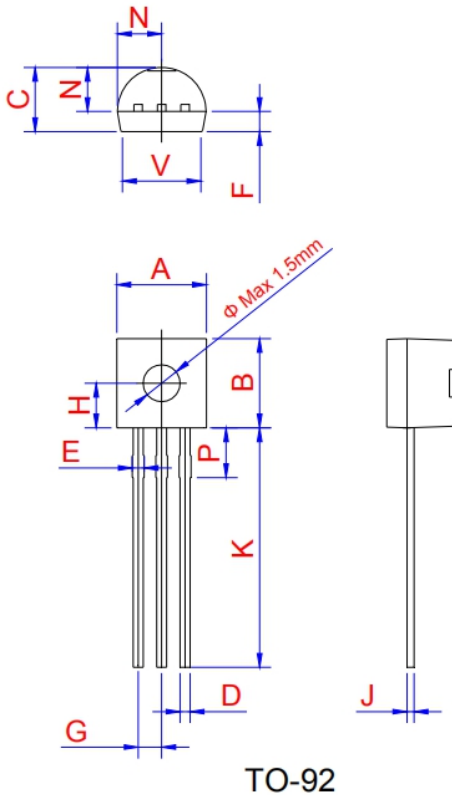

Ref.	Dimensions					
	Millimeters			Inches		
	Min.	Typ.	Max.	Min.	Typ.	Max.
A	4.45	4.6	5.2	0.175	0.181	0.205
B	4.32	4.6	5.33	0.17	0.181	0.21
C	3.18	3.55	4.19	0.125	0.14	0.165
D	0.407		0.533	0.016		0.021
E	0.6		0.8	0.024	0	0.031
F	-	1.1	-	-	0.043	-
G	-	1.27	-	-	0.05	-
H	-	2.3	-	-	0.091	-
J	0.36	0.38	0.5	0.014	0.015	0.02
K	12.7		15	0.5		0.591
N	2.04	2.3	2.66	0.08	0.091	0.105
P	1.86		2.06	0.073		0.081
V	-		4.3	-		0.169

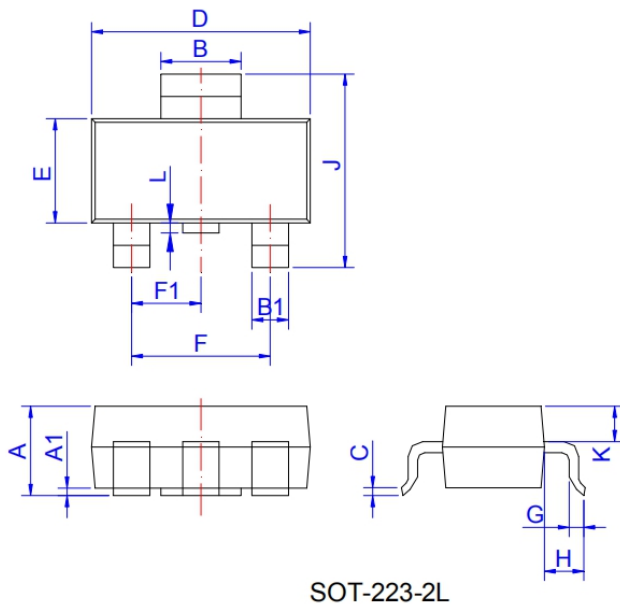

Ref.	Dimensions					
	Millimeters			Inches		
	Min.	Typ.	Max.	Min.	Typ.	Max.
A	1.5	1.6	1.8	0.059	0.063	0.071
A1	0.01	0.06	0.10	0.001	0.002	0.004
B	2.9	3.0	3.1	0.114	0.118	0.122
B1	0.6	0.7	0.8	0.024	0.028	0.031
C	0.22	0.26	0.32	0.009	0.010	0.013
D	6.3	6.5	6.7	0.248	0.256	0.264
E	3.3	3.5	3.7	0.130	0.138	0.146
F		4.6			0.181	
F1		2.3			0.091	
G	0.7	0.9	1.1	0.028	0.035	0.043
H	1.5	1.75	2	0.059	0.069	0.079
J	6.7	7.0	7.3	0.264	0.276	0.287
K		0.9			0.035	
L	0	0.1	0.2	0	0.004	0.008

FIG.1: Maximum power dissipation versus RMS on-state current

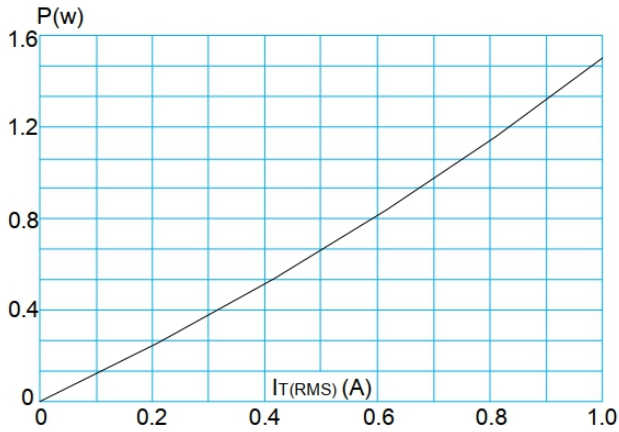

FIG.2: RMS on-state current versus case temperature

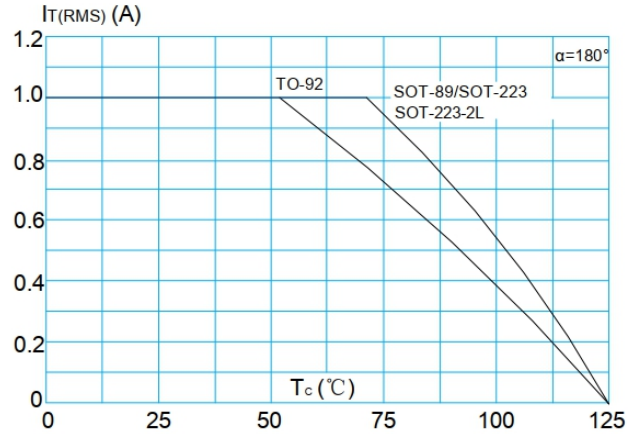

FIG.3: Surge peak on-state current versus number of cycles

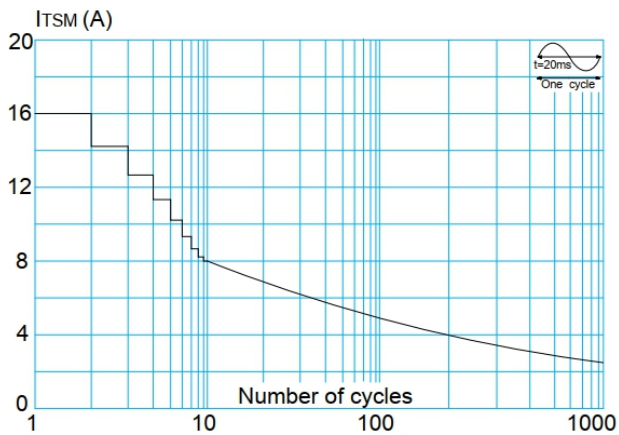

FIG.4: On-state characteristics (maximum values)

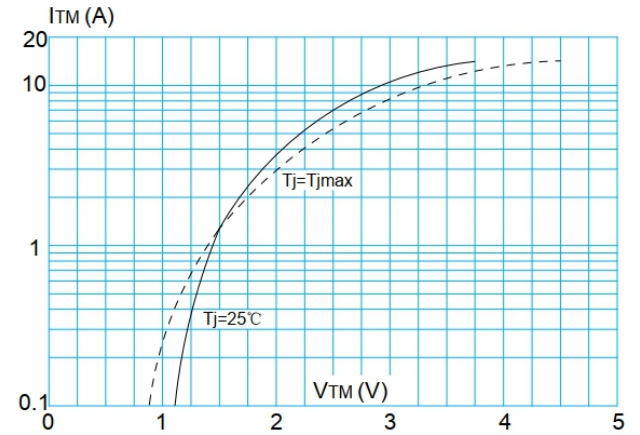

FIG.5: Non-repetitive surge peak on-state current for a sinusoidal pulse with width $t_p < 20ms$, and corresponding value of $I^2 t$ ($di/dt < 50A/\mu s$)

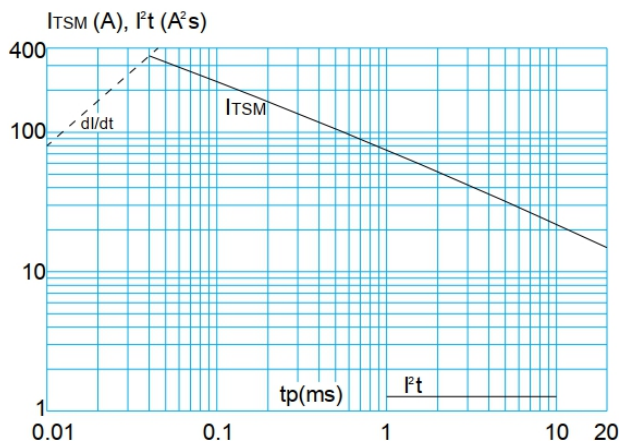

FIG.6: Relative variations of gate trigger current, holding current and latching current versus junction temperature

