



SGM8051/SGM8052/SGM8053 SGM8054/SGM8055 250MHz, Rail-to-Rail Output, CMOS Operational Amplifiers

GENERAL DESCRIPTION

The SGM8051/3 (single), SGM8052/5 (dual) and SGM8054 (quad) are high speed operational amplifiers with voltage feedback function. These devices can operate from 2.5V to 5.5V single supply. The SGM8051/2/3/4/5 feature an 8mV maximum input offset voltage and offer a low supply current of 2.3mA/amplifier.

The SGM8051/2/3/4/5 have excellent performance. They exhibit a wide bandwidth of 250MHz ($G=+1$) and a 0.1dB gain flatness of 37MHz ($G=+2$).

The SGM8051/2/3/4/5 provide wide input common mode voltage range and rail-to-rail output swing. The fast settling time and low distortion make the operational amplifiers appropriate for high speed ADC/DAC. The supply current of SGM8053/5 is 75 μ A in shutdown mode. The devices are suitable for use in portable instrumentation and battery-powered systems.

The SGM8051 is available in Green SOT-23-5 and SOIC-8 packages. The SGM8052 is available in Green SOIC-8 and MSOP-8 packages. The SGM8053 is available in Green SOT-23-6 and SOIC-8 packages. The SGM8054 is available in Green SOIC-14 and TSSOP-14 packages. The SGM8055 is available in a Green MSOP-10 package. They are specified over the extended -40°C to +125°C temperature range.

APPLICATIONS

ADC
DVD
Filter
Hand Set
Imaging
Base Station
Photodiode Preamp

FEATURES

- **High Speed:**
 - 3dB Bandwidth ($G = +1$): 250MHz
 - Slew Rate: 130V/ μ s
 - Settling Time to 0.1% with 2V Step: 58ns
- **Excellent Video Performance ($R_L = 150\Omega$, $G = +2$):**
 - 0.1dB Gain Flatness: 37MHz
 - Diff Gain: 0.03%, Diff Phase: 0.08°
- **Input Offset Voltage: 8mV (MAX)**
- **Rail-to-Rail Output**
- **Supply Voltage Range: 2.5V to 5.5V**
- **Input Common Mode Voltage Range:**
 - 0.2V to 3.8V with $V_S = 5V$
- **Low Supply Current:**
 - 2.3mA/Amplifier (TYP)
 - 75 μ A Shutdown Current for SGM8053/5
- **Small Packaging:**
 - SGM8051 Available in Green SOT-23-5 and SOIC-8 Packages
 - SGM8052 Available in Green MSOP-8 and SOIC-8 Packages
 - SGM8053 Available in Green SOT-23-6 and SOIC-8 Packages
 - SGM8054 Available in Green TSSOP-14 and SOIC-14 Packages
 - SGM8055 Available in a Green MSOP-10 Package

PACKAGE/ORDERING INFORMATION

MODEL	CHANNEL	PACKAGE DESCRIPTION	SPECIFIED TEMPERATURE RANGE	ORDERING NUMBER	PACKAGE MARKING	PACKING OPTION
SGM8051	Single	SOT-23-5	-40°C to +125°C	SGM8051XN5/TR	8051	Tape and Reel, 3000
		SOIC-8	-40°C to +125°C	SGM8051XS/TR	SGM8051XS XXXXX	Tape and Reel, 2500
SGM8052	Dual	MSOP-8	-40°C to +125°C	SGM8052XMS/TR	SGM8052 XMS XXXXX	Tape and Reel, 3000
		SOIC-8	-40°C to +125°C	SGM8052XS/TR	SGM8052XS XXXXX	Tape and Reel, 2500
SGM8053	Single with Shutdown	SOT-23-6	-40°C to +125°C	SGM8053XN6/TR	SOFXX	Tape and Reel, 3000
		SOIC-8	-40°C to +125°C	SGM8053XS/TR	SGM8053XS XXXXX	Tape and Reel, 2500
SGM8054	Quad	SOIC-14	-40°C to +125°C	SGM8054XS14/TR	SGM8054XS14 XXXXX	Tape and Reel, 2500
		TSSOP-14	-40°C to +125°C	SGM8054XTS14/TR	SGM8054 XTS14 XXXXX	Tape and Reel, 3000
SGM8055	Dual with Shutdown	MSOP-10	-40°C to +125°C	SGM8055XMS/TR	SGM8055 XMS XXXXX	Tape and Reel, 3000

MARKING INFORMATION

NOTE: XX = Date Code. XXXXX = Date Code and Vendor Code.

SOT-23-6

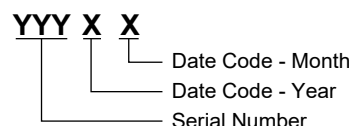

SOIC-8/MSOP-8/SOIC-14/TSSOP-14/MSOP-10

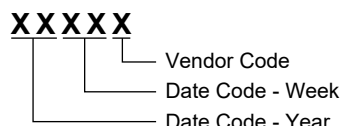

Green (RoHS & HSF): SG Micro Corp defines "Green" to mean Pb-Free (RoHS compatible) and free of halogen substances. If you have additional comments or questions, please contact your SGMICRO representative directly.

ABSOLUTE MAXIMUM RATINGS

Supply Voltage, +Vs to -Vs	6V
Input Common Mode Voltage Range (-Vs) - 0.1V to (+Vs) + 0.1V	
Signal Input Terminals Voltage Range (-Vs) - 0.3V to (+Vs) + 0.3V	
Package Thermal Resistance @ TA = +25°C	
SOT-23-5, θJA	190°C/W
SOT-23-6, θJA	190°C/W
SOIC-8, θJA	125°C/W
MSOP-8, θJA	216°C/W
MSOP-10, θJA	216°C/W
Junction Temperature	+150°C
Storage Temperature Range	-65°C to +150°C
Lead Temperature (Soldering, 10s)	+260°C
ESD Susceptibility	
HBM	1000V
MM	400V

RECOMMENDED OPERATING CONDITIONS

Operating Temperature Range	-40°C to +125°C
-----------------------------------	-----------------

OVERSTRESS CAUTION

Stresses beyond those listed in Absolute Maximum Ratings may cause permanent damage to the device. Exposure to absolute maximum rating conditions for extended periods may affect reliability. Functional operation of the device at any conditions beyond those indicated in the Recommended Operating Conditions section is not implied.

ESD SENSITIVITY CAUTION

This integrated circuit can be damaged if ESD protections are not considered carefully. SGMICRO recommends that all integrated circuits be handled with appropriate precautions. Failure to observe proper handling and installation procedures can cause damage. ESD damage can range from subtle performance degradation to complete device failure. Precision integrated circuits may be more susceptible to damage because even small parametric changes could cause the device not to meet the published specifications.

DISCLAIMER

SG Micro Corp reserves the right to make any change in circuit design, or specifications without prior notice.

PIN CONFIGURATIONS

SGM8051 (TOP VIEW)

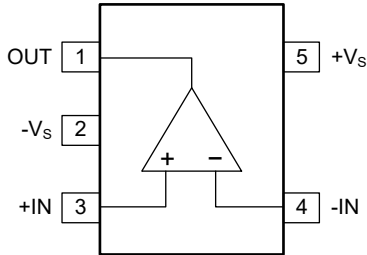

SOT-23-5

SGM8053 (TOP VIEW)

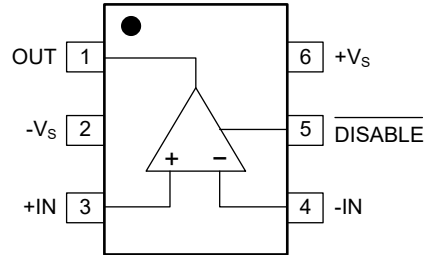

SOT-23-6

SGM8052 (TOP VIEW)

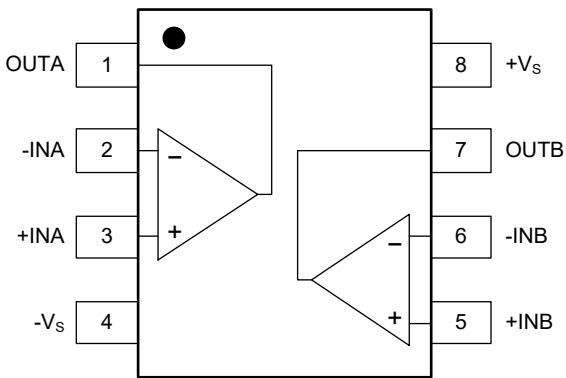

SOIC-8/MSOP-8

SGM8051/8053 (TOP VIEW)

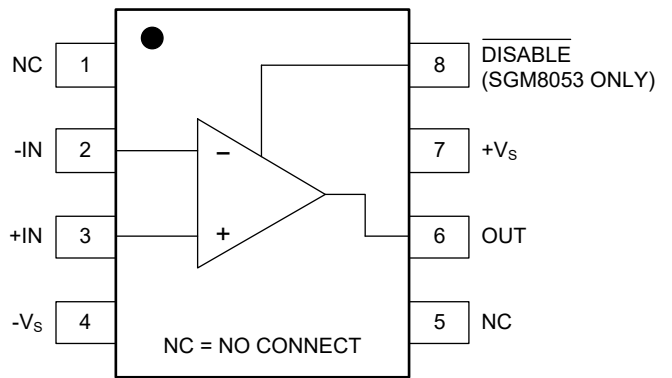

SOIC-8

SGM8054 (TOP VIEW)

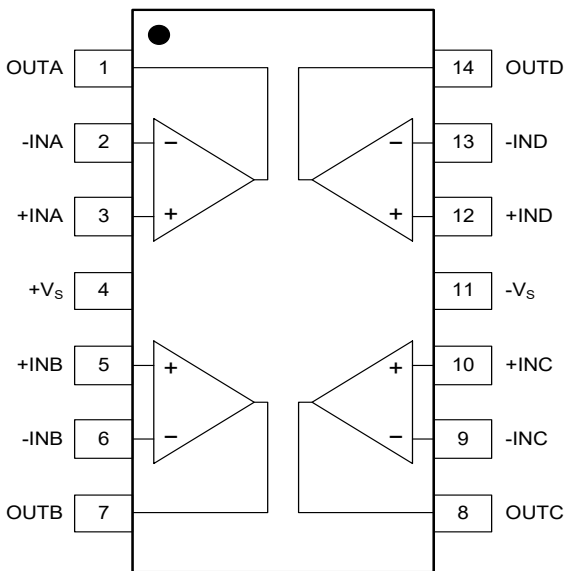

TSSOP-14/SOIC-14

SGM8055 (TOP VIEW)

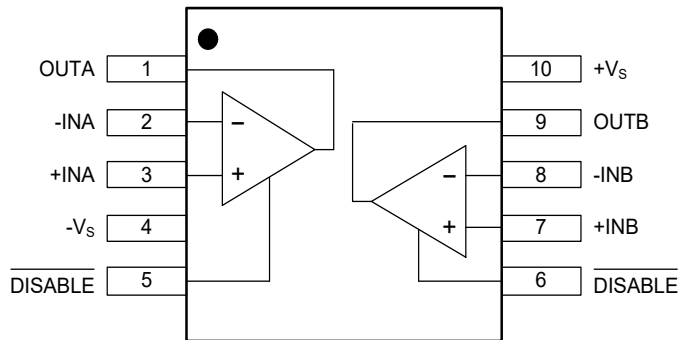

MSOP-10

ELECTRICAL CHARACTERISTICS

($V_S = 5V$, $G = +2$, $R_F = 887\Omega$, $R_L = 150\Omega$, unless otherwise noted.)

PARAMETER	CONDITIONS	SGM8051/2/3/4/5							
		TYP	MIN/MAX OVER TEMPERATURE					UNITS	MIN/ MAX
		+25°C	+25°C	0°C to +70°C	-40°C to +85°C	-40°C to +125°C			
Dynamic Performance									
-3dB Small-Signal Bandwidth	$G = +1, V_{OUT} = 0.1V_{P-P}, R_F = 24\Omega, R_L = 150\Omega$	180						MHz	TYP
	$G = +1, V_{OUT} = 0.1V_{P-P}, R_F = 24\Omega, R_L = 1k\Omega$	250						MHz	TYP
	$G = +2, V_{OUT} = 0.1V_{P-P}, R_L = 50\Omega$	40						MHz	TYP
	$G = +2, V_{OUT} = 0.1V_{P-P}, R_L = 150\Omega$	80						MHz	TYP
	$G = +2, V_{OUT} = 0.1V_{P-P}, R_L = 1k\Omega$	130						MHz	TYP
	$G = +2, V_{OUT} = 0.1V_{P-P}, R_L = 10k\Omega$	160						MHz	TYP
Gain-Bandwidth Product	$G = +10, R_L = 150\Omega$	90						MHz	TYP
	$G = +10, R_L = 1k\Omega$	120						MHz	TYP
Bandwidth for 0.1dB Flatness	$G = +2, V_{OUT} = 0.1V_{P-P}, R_L = 150\Omega, R_F = 887\Omega$	37						MHz	TYP
Slew Rate	$G = +1, 2V$ output step	93/-118						V/ μ s	TYP
	$G = +2, 2V$ output step	116/-103						V/ μ s	TYP
	$G = +2, 4V$ output step	130/-130						V/ μ s	TYP
Rise-and-Fall Time	$G = +2, V_{OUT} = 0.2V_{P-P}, 10\%$ to 90%	4						ns	TYP
	$G = +2, V_{OUT} = 2V_{P-P}, 10\%$ to 90%	14						ns	TYP
Settling Time to 0.1%	$G = +2, 2V$ output step	58						ns	TYP
Overload Recovery Time	$V_{IN} \cdot G = +V_S$	18						ns	TYP
Noise/Distortion Performance									
Input Voltage Noise Density	$f = 1MHz$	8.1						nV/ \sqrt{Hz}	TYP
Differential Gain Error (NTSC)	$G = +2, R_L = 150\Omega$	0.03						%	TYP
Differential Phase Error (NTSC)	$G = +2, R_L = 150\Omega$	0.08						degree	TYP
DC Performance									
Input Offset Voltage (V_{OS})		± 2	± 8	± 8.9	± 9.5	± 9.8		mV	MAX
Input Offset Voltage Drift		4.4						$\mu V/^\circ C$	TYP
Input Bias Current (I_B)		6						pA	TYP
Input Offset Current (I_{OS})		2						pA	TYP
Open-Loop Gain (A_{OL})	$V_{OUT} = 0.3V$ to $4.7V, R_L = 150\Omega$	80	75	74	74	73		dB	MIN
	$V_{OUT} = 0.2V$ to $4.8V, R_L = 1k\Omega$	104	92	91	91	80		dB	MIN
Input Characteristics									
Input Common Mode Voltage Range (V_{CM})		-0.2 to 3.8						V	TYP
Common Mode Rejection Ratio (CMRR)	$V_{CM} = -0.1V$ to $3.5V$	80	66	65	65	62		dB	MIN
Output Characteristics									
Output Voltage Swing from Rail	$R_L = 150\Omega$	0.12						V	TYP
	$R_L = 1k\Omega$	0.03						V	TYP
Output Current		130	100	95	90	84		mA	MIN
Closed-Loop Output Impedance	$f < 100kHz$	0.08						Ω	TYP
Power-Down (SGM8053/5 Only)									
Turn-On Time		236						ns	TYP
Turn-Off Time		52						ns	TYP
$\overline{DISABLE}$ Voltage-Off			0.8					V	MAX
$\overline{DISABLE}$ Voltage-On			2					V	MIN
Output Leakage Current (I_{OFF}) (SGM8055 Only)	$\overline{DISABLE} = 0V, V_S = 5V, V_{OUT} = 5V$	50						pA	TYP
Power Supply									
Operating Voltage Range			2.5	2.7	2.7	2.7		V	MIN
			5.5	5.5	5.5	5.5		V	MAX
Quiescent Current (per Amplifier)		2.3	3.2	3.4	3.8	4		mA	MAX
Supply Current when Disabled per Amplifier (SGM8053/5 only)		75	120	127	130	137		μA	MAX
Power Supply Rejection Ratio (PSRR)	$V_S = 2.7V$ to $5.5V, V_{CM} = (-V_S) + 0.5V$	80	67	67	65	62		dB	MIN

TYPICAL PERFORMANCE CHARACTERISTICS

At $T_A = +25^\circ\text{C}$, $V_S = 5\text{V}$, $G = +2$, $R_F = 887\Omega$, $R_G = 887\Omega$ and $R_L = 150\Omega$ connected to $V_S/2$, unless otherwise noted.

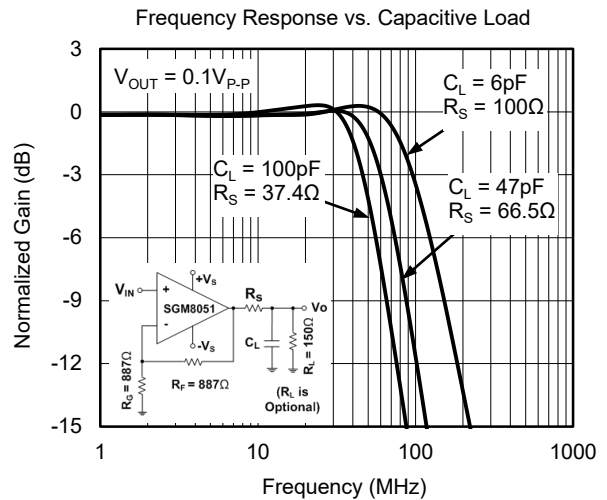
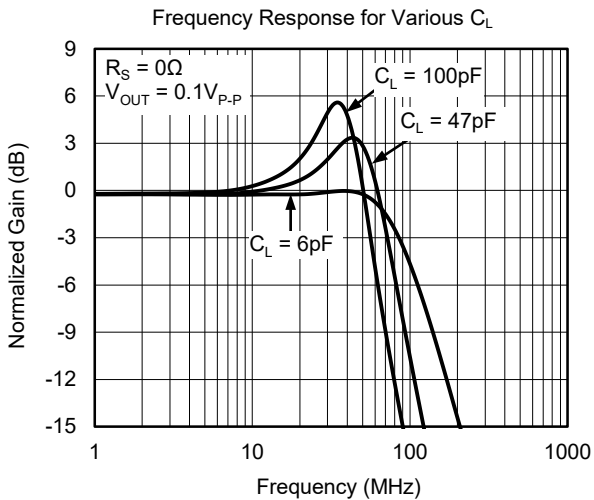
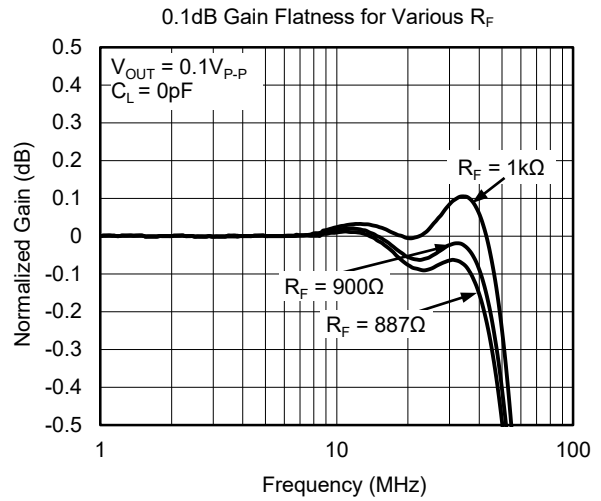
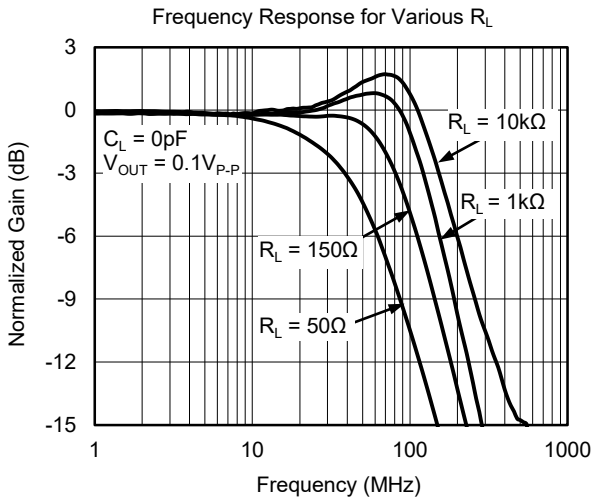
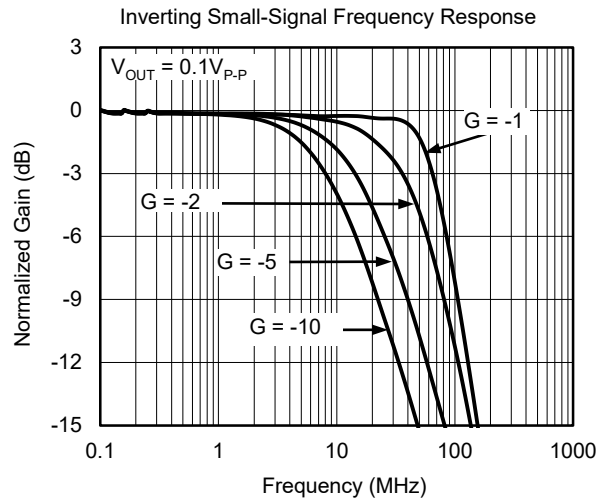
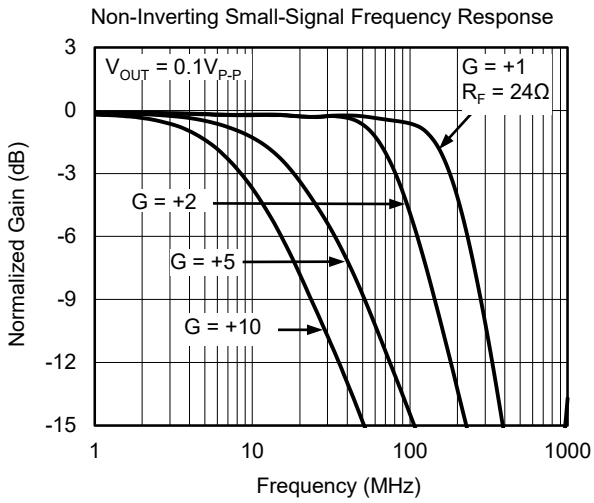

TYPICAL PERFORMANCE CHARACTERISTICS (continued)

At $T_A = +25^\circ\text{C}$, $V_S = 5\text{V}$, $G = +2$, $R_F = 887\Omega$, $R_G = 887\Omega$ and $R_L = 150\Omega$ connected to $V_S/2$, unless otherwise noted.

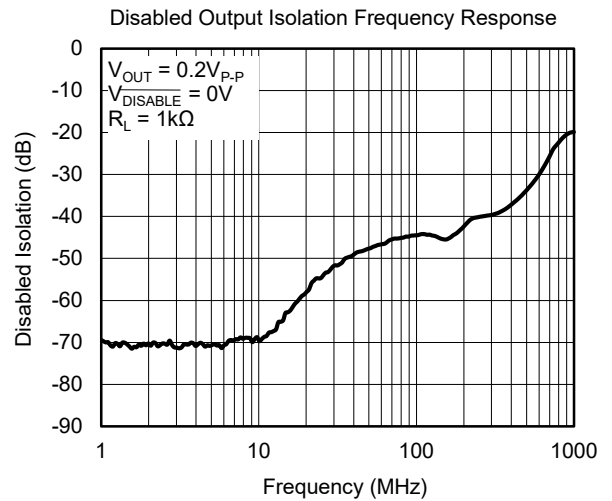
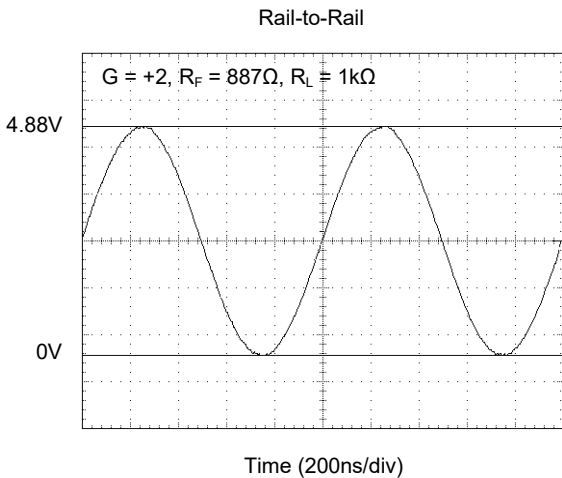
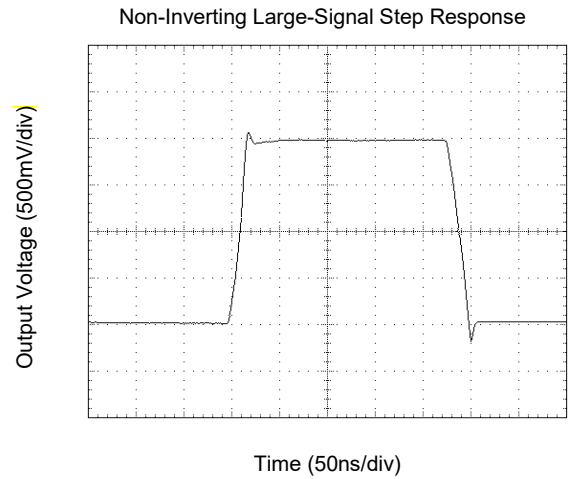
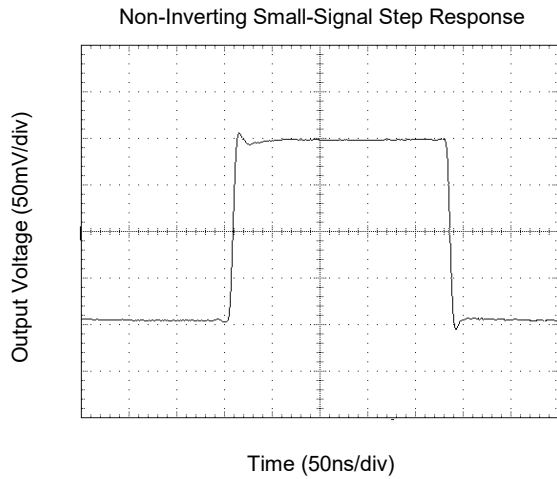
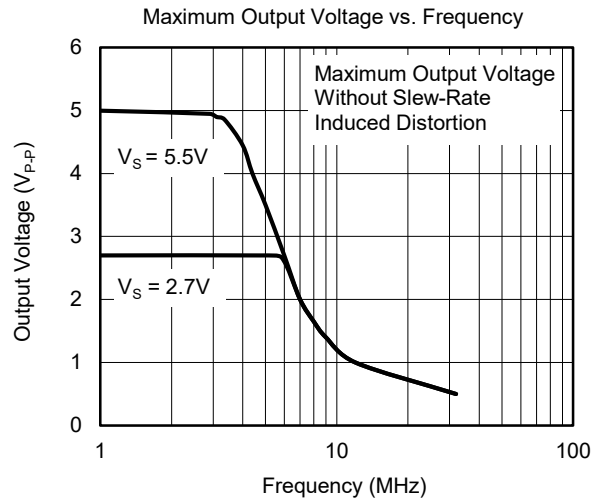
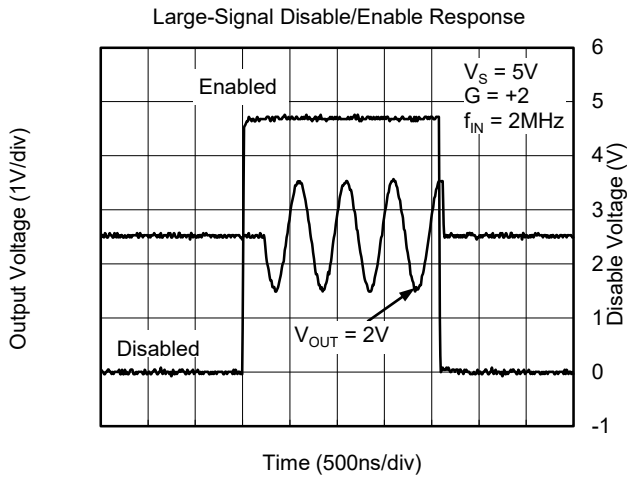

TYPICAL PERFORMANCE CHARACTERISTICS (continued)

At $T_A = +25^\circ\text{C}$, $V_S = 5\text{V}$, $G = +2$, $R_F = 887\Omega$, $R_G = 887\Omega$ and $R_L = 150\Omega$ connected to $V_S/2$, unless otherwise noted.

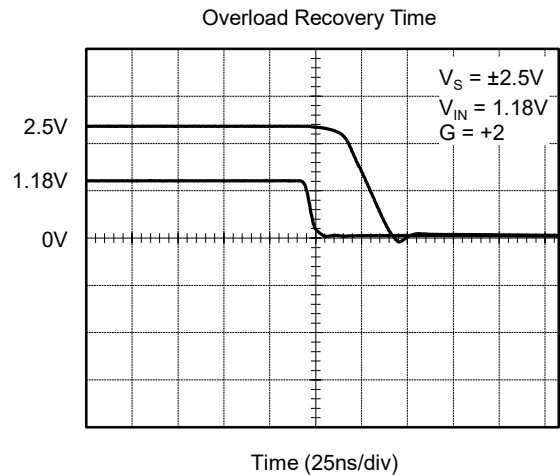
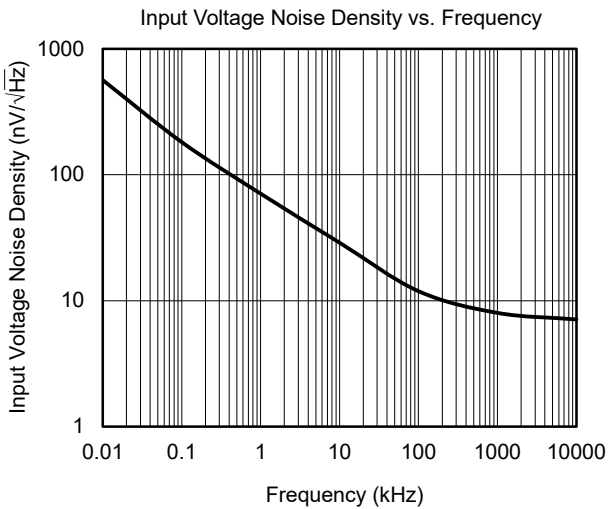
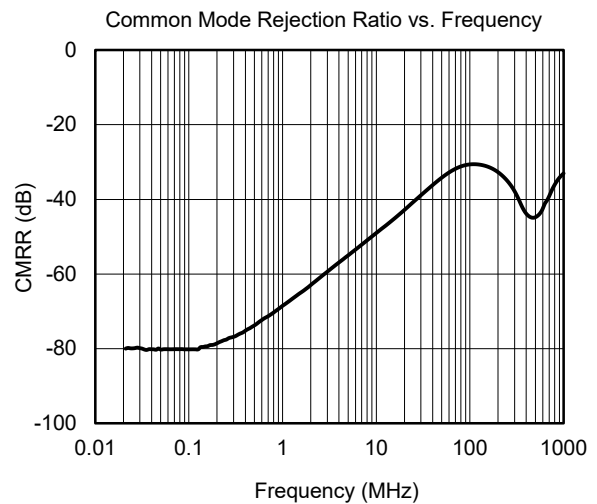
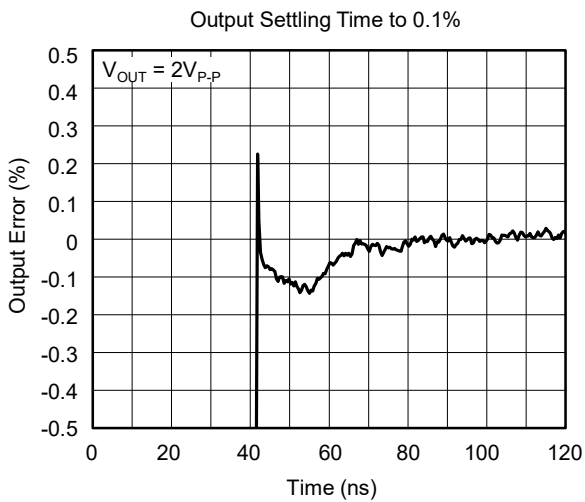
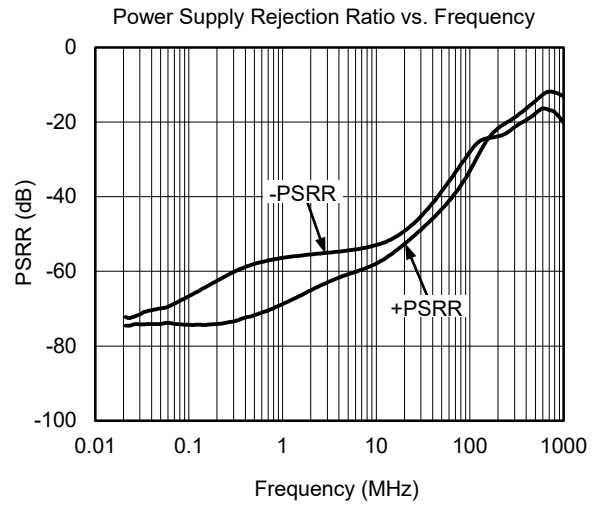
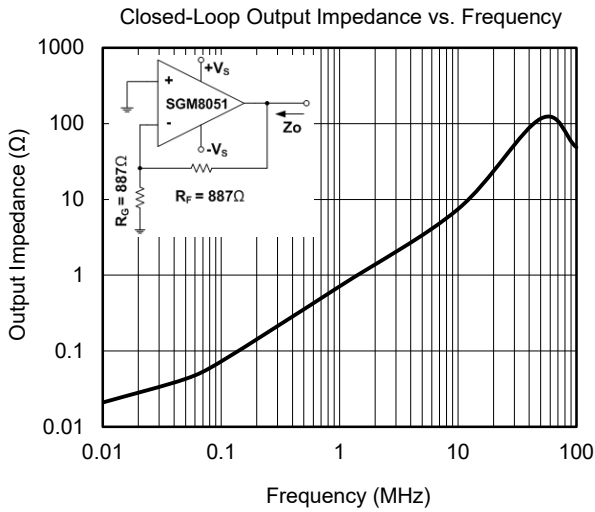

TYPICAL PERFORMANCE CHARACTERISTICS (continued)

At $T_A = +25^\circ\text{C}$, $V_S = 5\text{V}$, $G = +2$, $R_F = 887\Omega$, $R_G = 887\Omega$ and $R_L = 150\Omega$ connected to $V_S/2$, unless otherwise noted.

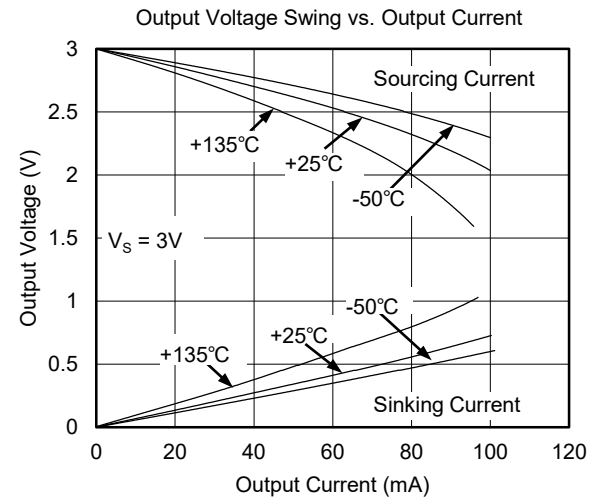
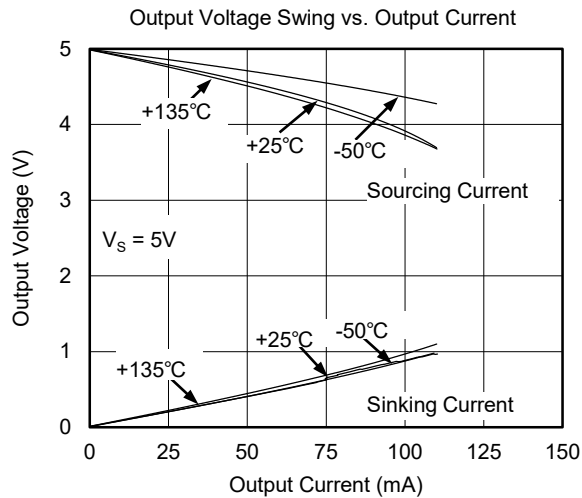
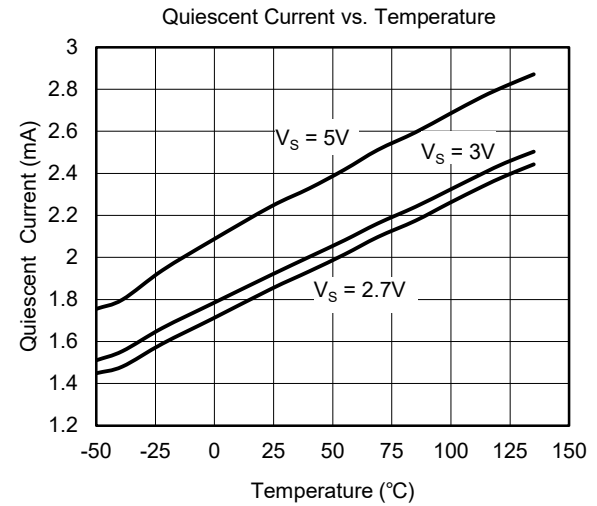
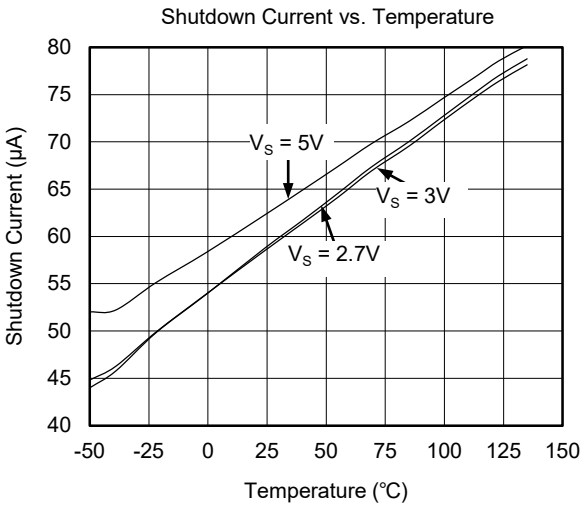
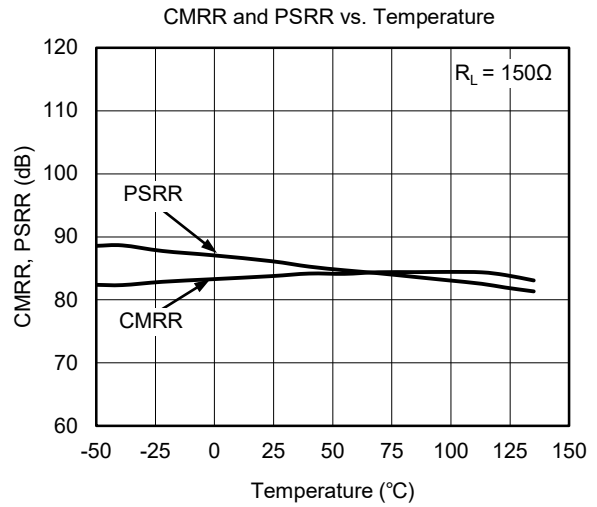
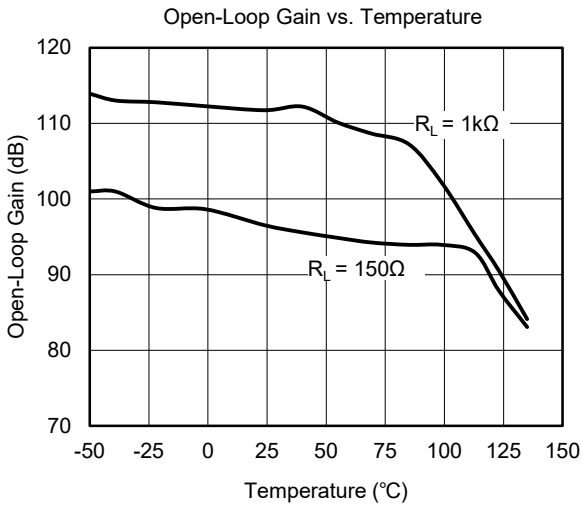

TYPICAL PERFORMANCE CHARACTERISTICS (continued)

At $T_A = +25^\circ\text{C}$, $V_S = 5\text{V}$, $G = +2$, $R_F = 887\Omega$, $R_G = 887\Omega$ and $R_L = 150\Omega$ connected to $V_S/2$, unless otherwise noted.

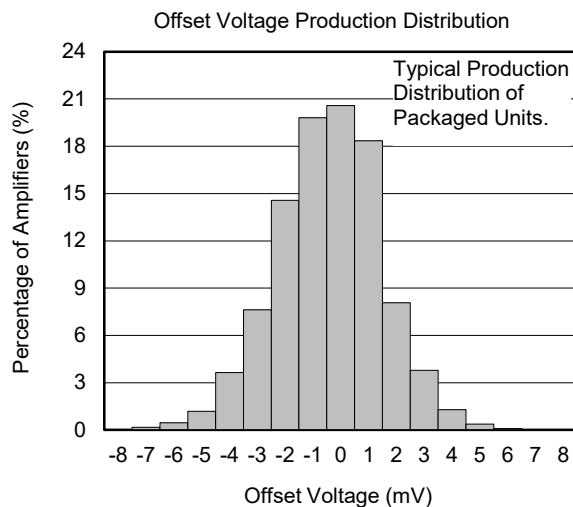
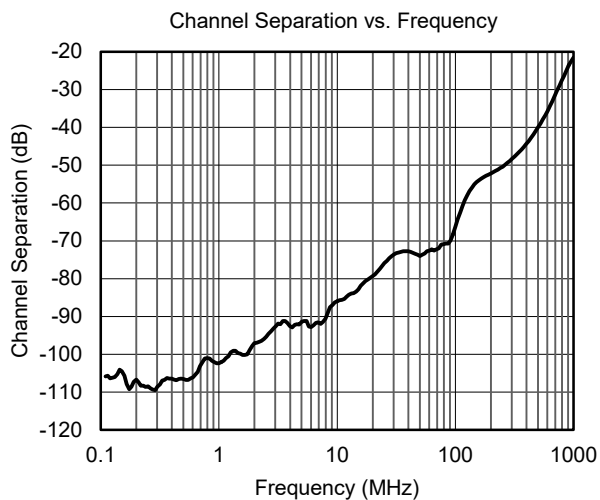

REVISION HISTORY

NOTE: Page numbers for previous revisions may differ from page numbers in the current version.

JUNE 2017 – REV.E to REV.E.1	Page
Changed Package/Ordering Information section.....	2
Updated Electrical Characteristics section	2
Changed Absolute Maximum Ratings section.....	3

MAY 2014 – REV.D.4 to REV.E	Page
Changed Package/Ordering Information section.....	2

JANUARY 2013 – REV.D.3 to REV.D.4	Page
Updated Package Outline Dimensions section	12 ~ 18
Added Tape and Reel Information section	19, 20

PACKAGE OUTLINE DIMENSIONS

SOT-23-5

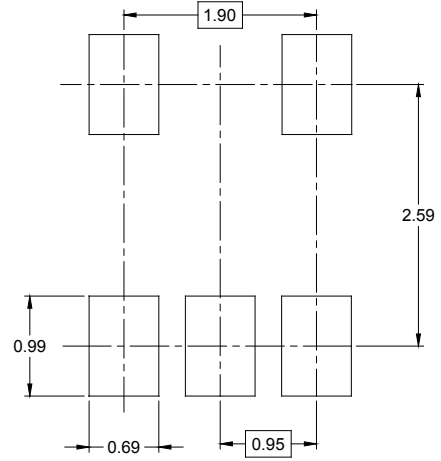
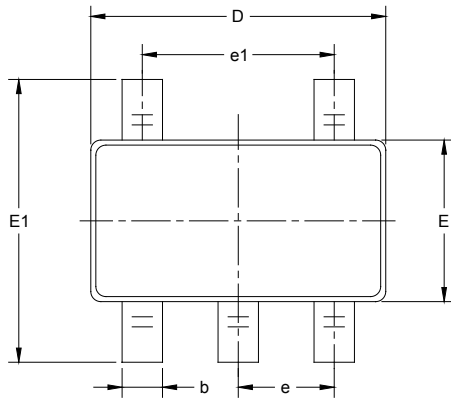

RECOMMENDED LAND PATTERN (Unit: mm)

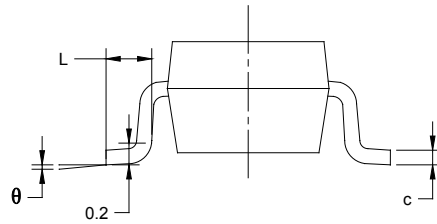
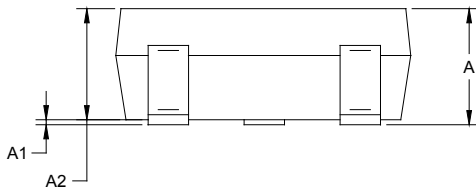

Symbol	Dimensions In Millimeters		Dimensions In Inches	
	MIN	MAX	MIN	MAX
A	1.050	1.250	0.041	0.049
A1	0.000	0.100	0.000	0.004
A2	1.050	1.150	0.041	0.045
b	0.300	0.500	0.012	0.020
c	0.100	0.200	0.004	0.008
D	2.820	3.020	0.111	0.119
E	1.500	1.700	0.059	0.067
E1	2.650	2.950	0.104	0.116
e	0.950 BSC		0.037 BSC	
e1	1.900 BSC		0.075 BSC	
L	0.300	0.600	0.012	0.024
θ	0°	8°	0°	8°

PACKAGE OUTLINE DIMENSIONS

SOT-23-6

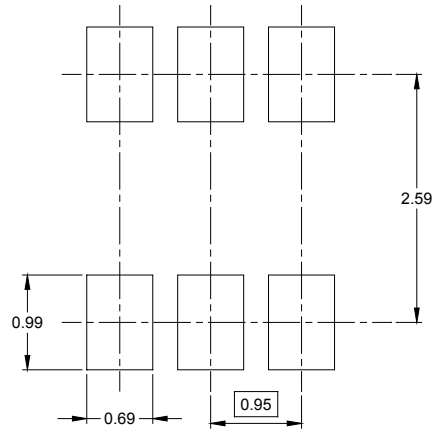
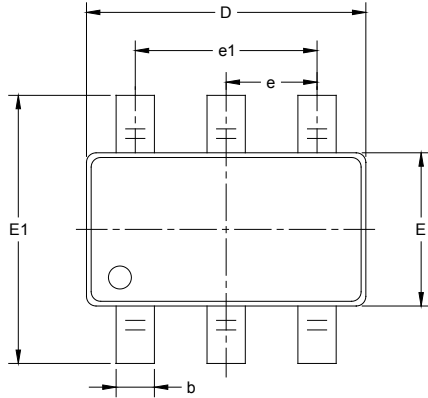

RECOMMENDED LAND PATTERN (Unit: mm)

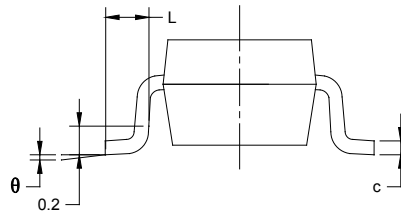
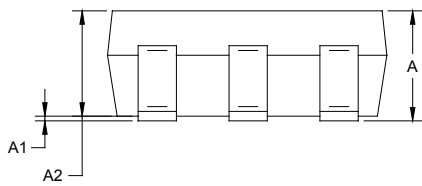

Symbol	Dimensions In Millimeters		Dimensions In Inches	
	MIN	MAX	MIN	MAX
A	1.050	1.250	0.041	0.049
A1	0.000	0.100	0.000	0.004
A2	1.050	1.150	0.041	0.045
b	0.300	0.500	0.012	0.020
c	0.100	0.200	0.004	0.008
D	2.820	3.020	0.111	0.119
E	1.500	1.700	0.059	0.067
E1	2.650	2.950	0.104	0.116
e	0.950 BSC		0.037 BSC	
e1	1.900 BSC		0.075 BSC	
L	0.300	0.600	0.012	0.024
θ	0°	8°	0°	8°

PACKAGE OUTLINE DIMENSIONS

SOIC-8

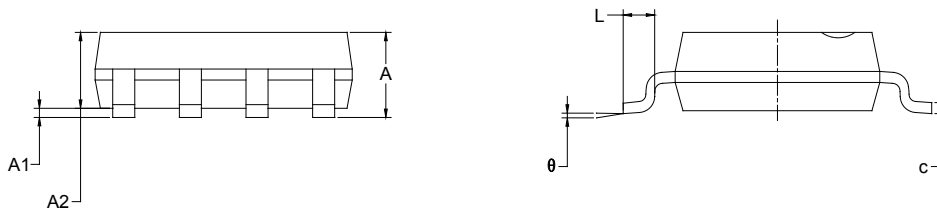
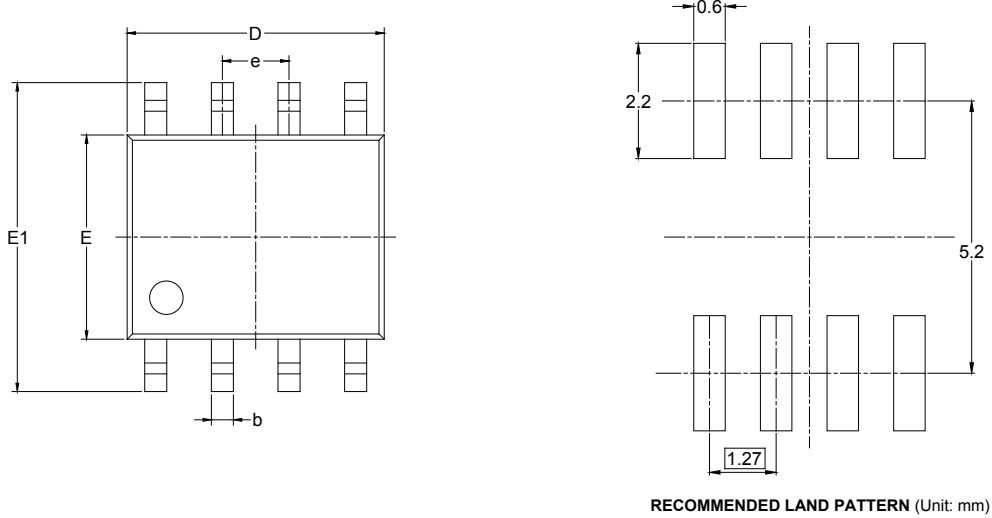

Symbol	Dimensions In Millimeters		Dimensions In Inches	
	MIN	MAX	MIN	MAX
A	1.350	1.750	0.053	0.069
A1	0.100	0.250	0.004	0.010
A2	1.350	1.550	0.053	0.061
b	0.330	0.510	0.013	0.020
c	0.170	0.250	0.006	0.010
D	4.700	5.100	0.185	0.200
E	3.800	4.000	0.150	0.157
E1	5.800	6.200	0.228	0.244
e	1.27 BSC		0.050 BSC	
L	0.400	1.270	0.016	0.050
θ	0°	8°	0°	8°

PACKAGE OUTLINE DIMENSIONS

MSOP-8

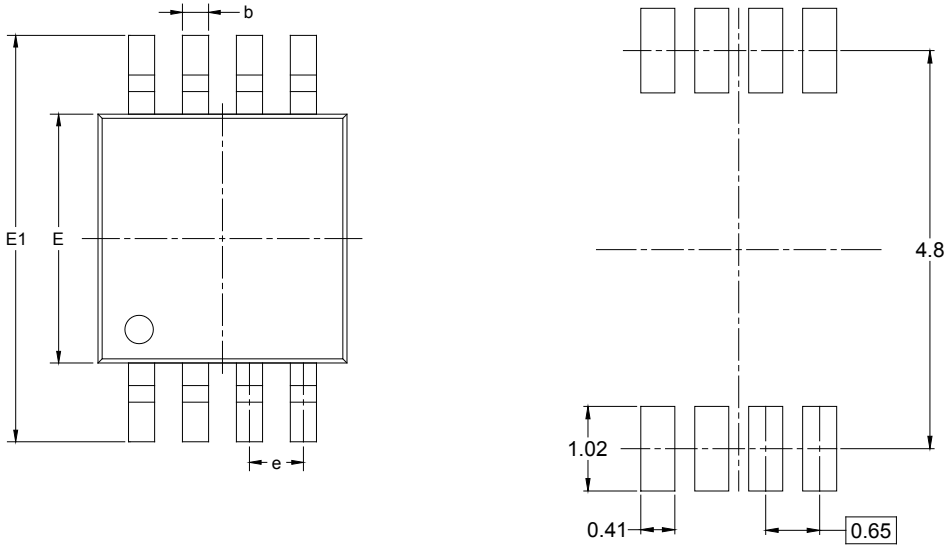

RECOMMENDED LAND PATTERN (Unit: mm)

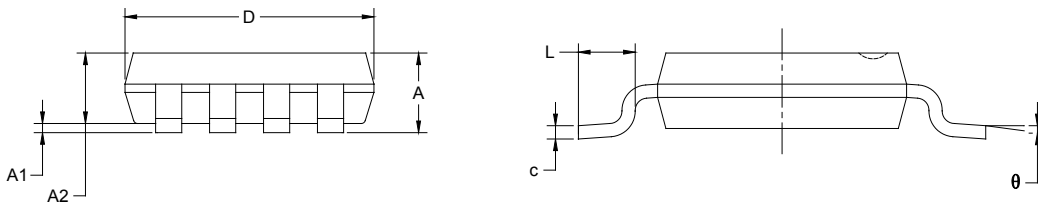

Symbol	Dimensions In Millimeters		Dimensions In Inches	
	MIN	MAX	MIN	MAX
A	0.820	1.100	0.032	0.043
A1	0.020	0.150	0.001	0.006
A2	0.750	0.950	0.030	0.037
b	0.250	0.380	0.010	0.015
c	0.090	0.230	0.004	0.009
D	2.900	3.100	0.114	0.122
E	2.900	3.100	0.114	0.122
E1	4.750	5.050	0.187	0.199
e	0.650 BSC		0.026 BSC	
L	0.400	0.800	0.016	0.031
θ	0°	6°	0°	6°

PACKAGE OUTLINE DIMENSIONS

MSOP-10

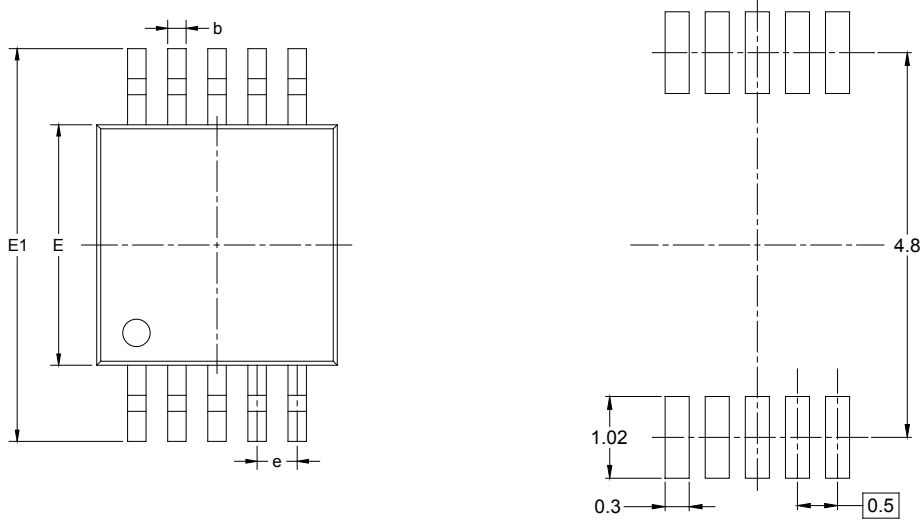

RECOMMENDED LAND PATTERN (Unit: mm)

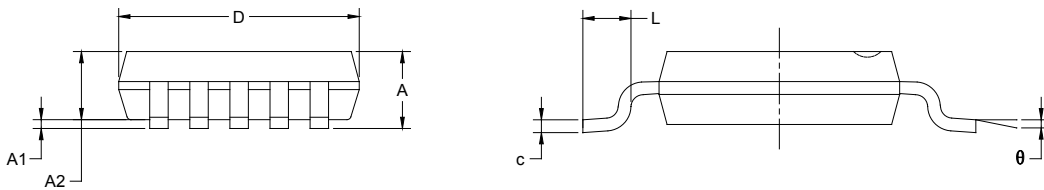

Symbol	Dimensions In Millimeters		Dimensions In Inches	
	MIN	MAX	MIN	MAX
A	0.820	1.100	0.032	0.043
A1	0.020	0.150	0.001	0.006
A2	0.750	0.950	0.030	0.037
b	0.180	0.280	0.007	0.011
c	0.090	0.230	0.004	0.009
D	2.900	3.100	0.114	0.122
E	2.900	3.100	0.114	0.122
E1	4.750	5.050	0.187	0.199
e	0.500 BSC		0.020 BSC	
L	0.400	0.800	0.016	0.031
θ	0°	6°	0°	6°

PACKAGE OUTLINE DIMENSIONS

SOIC-14

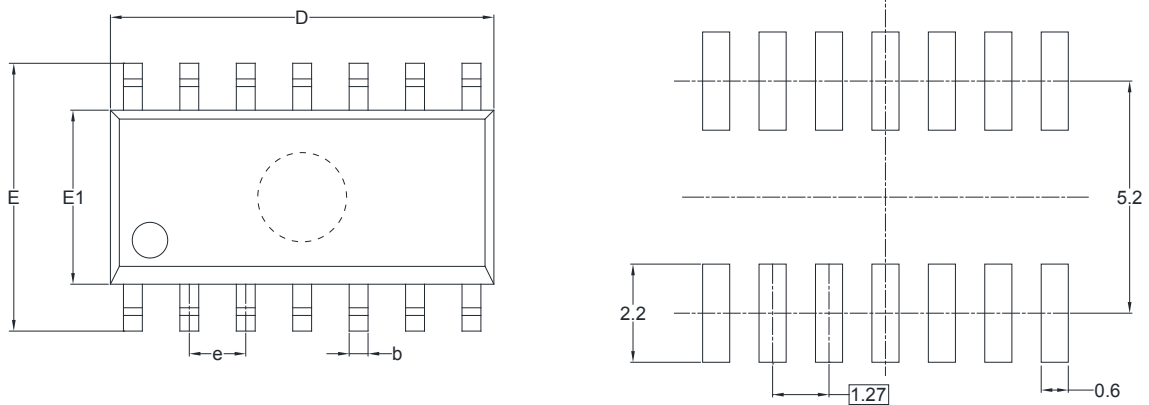

RECOMMENDED LAND PATTERN (Unit: mm)

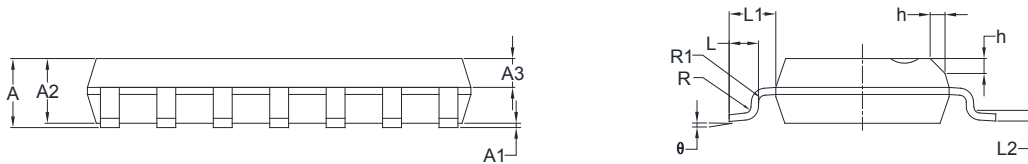

Symbol	Dimensions In Millimeters		Dimensions In Inches	
	MIN	MAX	MIN	MAX
A	1.35	1.75	0.053	0.069
A1	0.10	0.25	0.004	0.010
A2	1.25	1.65	0.049	0.065
A3	0.55	0.75	0.022	0.030
b	0.36	0.49	0.014	0.019
D	8.53	8.73	0.336	0.344
E	5.80	6.20	0.228	0.244
E1	3.80	4.00	0.150	0.157
e	1.27 BSC		0.050 BSC	
L	0.45	0.80	0.018	0.032
L1	1.04 REF		0.040 REF	
L2	0.25 BSC		0.01 BSC	
R	0.07		0.003	
R1	0.07		0.003	
h	0.30	0.50	0.012	0.020
θ	0°	8°	0°	8°

PACKAGE OUTLINE DIMENSIONS

TSSOP-14

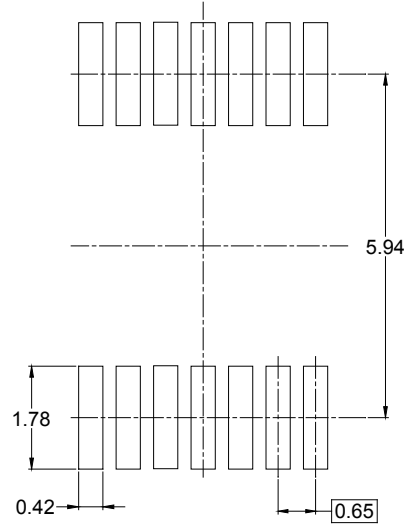
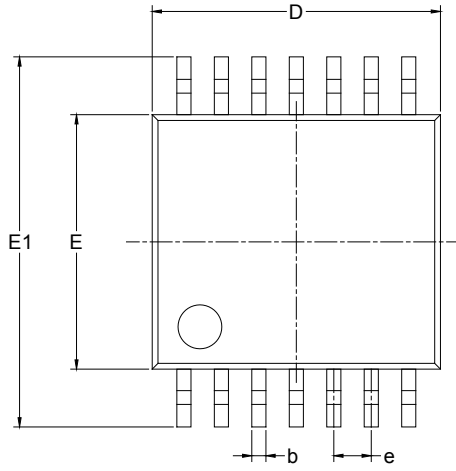

RECOMMENDED LAND PATTERN (Unit: mm)

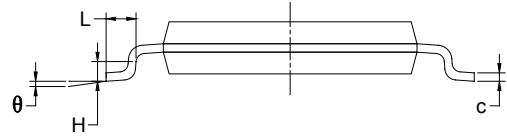
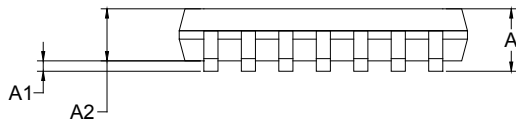

Symbol	Dimensions In Millimeters		Dimensions In Inches	
	MIN	MAX	MIN	MAX
A		1.200		0.047
A1	0.050	0.150	0.002	0.006
A2	0.800	1.050	0.031	0.041
b	0.190	0.300	0.007	0.012
c	0.090	0.200	0.004	0.008
D	4.860	5.100	0.191	0.201
E	4.300	4.500	0.169	0.177
E1	6.250	6.550	0.246	0.258
e	0.650 BSC		0.026 BSC	
L	0.500	0.700	0.02	0.028
H	0.25 TYP		0.01 TYP	
θ	1°	7°	1°	7°

PACKAGE INFORMATION

TAPE AND REEL INFORMATION

REEL DIMENSIONS



TAPE DIMENSIONS



NOTE: The picture is only for reference. Please make the object as the standard.

KEY PARAMETER LIST OF TAPE AND REEL

Package Type	Reel Diameter	Reel Width W1 (mm)	A0 (mm)	B0 (mm)	K0 (mm)	P0 (mm)	P1 (mm)	P2 (mm)	W (mm)	Pin1 Quadrant
SOT-23-5	7"	9.5	3.20	3.20	1.40	4.0	4.0	2.0	8.0	Q3
SOT-23-6	7"	9.5	3.17	3.23	1.37	4.0	4.0	2.0	8.0	Q3
SOIC-8	13"	12.4	6.40	5.40	2.10	4.0	8.0	2.0	12.0	Q1
MSOP-8	13"	12.4	5.20	3.30	1.50	4.0	8.0	2.0	12.0	Q1
MSOP-10	13"	12.4	5.20	3.30	1.20	4.0	8.0	2.0	12.0	Q1
SOIC-14	13"	16.4	6.60	9.30	2.10	4.0	8.0	2.0	16.0	Q1
TSSOP-14	13"	12.4	6.95	5.60	1.20	4.0	8.0	2.0	12.0	Q1

D00001

PACKAGE INFORMATION

CARTON BOX DIMENSIONS



NOTE: The picture is only for reference. Please make the object as the standard.

KEY PARAMETER LIST OF CARTON BOX

Reel Type	Length (mm)	Width (mm)	Height (mm)	Pizza/Carton
7" (Option)	368	227	224	8
7"	442	410	224	18
13"	386	280	370	5

DD0002