



# SGM2034

## Ultra Low Current Consumption and Low Dropout CMOS Voltage Regulators

### GENERAL DESCRIPTION

The SGM2034 series are positive voltage regulators with ultra low current consumption, low dropout voltage, high-accuracy output voltage and 250mA output current, developed in CMOS technology.

Output capacitor as small as 0.1 $\mu$ F can be used. The SGM2034 series operate with an ultra low current consumption of 1 $\mu$ A (TYP).

The built-in low on-resistance transistor realizes low dropout voltage and a large output current. A built-in over-current protection circuit prevents the load current from exceeding the current capacity of the output transistor. Reverse current is less than 0.4 $\mu$ A (TYP) when  $V_{OUT} > V_{IN}$ .

Compared with voltage regulators using a conventional CMOS technology, more types of capacitors, including small input and output capacitors, can be used with the SGM2034 series. The SGM2034 series feature ultra low current consumption and come in small packages, making them most suitable for portable equipment.

The SGM2034 is available in Green SOT-23-3 and SOT-89-3 packages. It operates over an ambient temperature range of -40°C to +85°C.

### FEATURES

- **Output Voltage: 1.2V to 5.2V with 0.05V per Step**
- **Input Voltage: 1.7V to 7.5V**
- **High Output Voltage Accuracy:  $\pm 1.2\%$**
- **Low Dropout Voltage: 75mV (TYP) at 100mA**
- **Ultra Low Current Consumption: 1 $\mu$ A (TYP)**
- **250mA Nominal Output Current**
- **Output Capacitor: Ceramic Capacitors of 0.1 $\mu$ F or Higher can be Used**
- **Low Reverse Leakage Current: 0.4 $\mu$ A (TYP) when  $V_{OUT} > V_{IN}$**
- **Built-In Over-Temperature Protection**
- **Built-In Over-Current Protection Circuit**
- **-40°C to +85°C Operating Temperature Range**
- **Available in Green SOT-23-3 and SOT-89-3 Packages**

### APPLICATIONS

Wearable Device  
Smart Phone  
Portable Equipment

**PACKAGE/ORDERING INFORMATION**

MODEL	PACKAGE DESCRIPTION	SPECIFIED TEMPERATURE RANGE	ORDERING NUMBER	PACKAGE MARKING	PACKING OPTION
<a href="#"><u>SGM2034-1.2</u></a>	SOT-23-3	-40°C to +85°C	<a href="#"><u>SGM2034-1.2YN3G/TR</u></a>	M90XX	Tape and Reel, 3000
	SOT-89-3	-40°C to +85°C	<a href="#"><u>SGM2034-1.2YK3G/TR</u></a>	M8FXX	Tape and Reel, 1000
<a href="#"><u>SGM2034-1.8</u></a>	SOT-23-3	-40°C to +85°C	<a href="#"><u>SGM2034-1.8YN3G/TR</u></a>	GRCXX	Tape and Reel, 3000
	SOT-89-3	-40°C to +85°C	<a href="#"><u>SGM2034-1.8YK3G/TR</u></a>	GR2XX	Tape and Reel, 1000
<a href="#"><u>SGM2034-2.5</u></a>	SOT-23-3	-40°C to +85°C	<a href="#"><u>SGM2034-2.5YN3G/TR</u></a>	M56XX	Tape and Reel, 3000
	SOT-89-3	-40°C to +85°C	<a href="#"><u>SGM2034-2.5YK3G/TR</u></a>	M57XX	Tape and Reel, 1000
<a href="#"><u>SGM2034-2.8</u></a>	SOT-23-3	-40°C to +85°C	<a href="#"><u>SGM2034-2.8YN3G/TR</u></a>	GR4XX	Tape and Reel, 3000
	SOT-89-3	-40°C to +85°C	<a href="#"><u>SGM2034-2.8YK3G/TR</u></a>	GR3XX	Tape and Reel, 1000
<a href="#"><u>SGM2034-3.0</u></a>	SOT-23-3	-40°C to +85°C	<a href="#"><u>SGM2034-3.0YN3G/TR</u></a>	GP9XX	Tape and Reel, 3000
	SOT-89-3	-40°C to +85°C	<a href="#"><u>SGM2034-3.0YK3G/TR</u></a>	M2EXX	Tape and Reel, 1000
<a href="#"><u>SGM2034-3.3</u></a>	SOT-23-3	-40°C to +85°C	<a href="#"><u>SGM2034-3.3YN3G/TR</u></a>	GRDXX	Tape and Reel, 3000
	SOT-89-3	-40°C to +85°C	<a href="#"><u>SGM2034-3.3YK3G/TR</u></a>	GR5XX	Tape and Reel, 1000
<a href="#"><u>SGM2034-3.6</u></a>	SOT-23-3	-40°C to +85°C	<a href="#"><u>SGM2034-3.6YN3G/TR</u></a>	GR7XX	Tape and Reel, 3000
	SOT-89-3	-40°C to +85°C	<a href="#"><u>SGM2034-3.6YK3G/TR</u></a>	GR6XX	Tape and Reel, 1000
<a href="#"><u>SGM2034-5.0</u></a>	SOT-23-3	-40°C to +85°C	<a href="#"><u>SGM2034-5.0YN3G/TR</u></a>	GREXX	Tape and Reel, 3000
	SOT-89-3	-40°C to +85°C	<a href="#"><u>SGM2034-5.0YK3G/TR</u></a>	GRAXX	Tape and Reel, 1000

**MARKING INFORMATION**

NOTE: XX = Date Code.

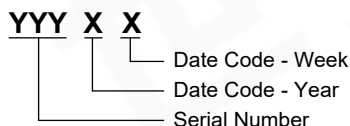

Green (RoHS & HSF): SG Micro Corp defines "Green" to mean Pb-Free (RoHS compatible) and free of halogen substances. If you have additional comments or questions, please contact your SGMICRO representative directly.

**ABSOLUTE MAXIMUM RATINGS**

IN to GND .....8V  
 OUT to GND .....6V  
 Package Thermal Resistance  
 SOT-23-3,  $\theta_{JA}$  ..... 283°C/W  
 SOT-89-3,  $\theta_{JA}$  ..... 101°C/W  
 Junction Temperature .....+150°C  
 Storage Temperature Range ..... -65°C to +150°C  
 Lead Temperature (Soldering, 10s) .....+260°C  
 ESD Susceptibility  
 HBM ..... 8000V  
 MM ..... 400V  
 CDM ..... 1000V

**RECOMMENDED OPERATING CONDITIONS**

Input Voltage Range .....1.7V to 7.5V  
 Operating Temperature Range ..... -40°C to +85°C

**OVERSTRESS CAUTION**

Stresses beyond those listed in Absolute Maximum Ratings may cause permanent damage to the device. Exposure to absolute maximum rating conditions for extended periods may affect reliability. Functional operation of the device at any conditions beyond those indicated in the Recommended Operating Conditions section is not implied.

**ESD SENSITIVITY CAUTION**

This integrated circuit can be damaged by ESD if you don't pay attention to ESD protection. SGMICRO recommends that all integrated circuits be handled with appropriate precautions. Failure to observe proper handling and installation procedures can cause damage. ESD damage can range from subtle performance degradation to complete device failure. Precision integrated circuits may be more susceptible to damage because very small parametric changes could cause the device not to meet its published specifications.

**DISCLAIMER**

SG Micro Corp reserves the right to make any change in circuit design, or specifications without prior notice.

**PIN CONFIGURATIONS**

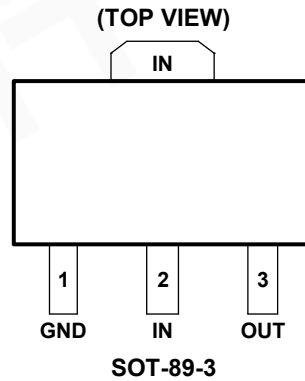
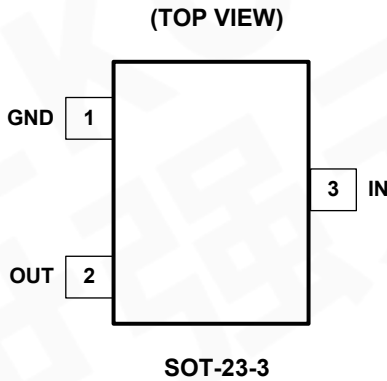

**PIN DESCRIPTION**

PIN		NAME	FUNCTION
SOT-23-3	SOT-89-3		
1	1	GND	Ground Pin.
2	3	OUT	Output Voltage Pin. It is recommended to use output capacitor with effective capacitance in the range of 0.1µF to 10µF.
3	2	IN	Input Voltage Supply Pin.

## ELECTRICAL CHARACTERISTICS

( $V_{IN} = V_{OUT(NOM)} + 1.0V$ ,  $I_{OUT} = 0.1mA$ ,  $C_{IN} = 1\mu F$ ,  $C_{OUT} = 0.1\mu F$ , Full =  $-40^{\circ}C$  to  $+85^{\circ}C$ , typical values are at  $T_A = +25^{\circ}C$ , unless otherwise noted.)

PARAMETER	SYMBOL	CONDITIONS	TEMP	MIN	TYP	MAX	UNITS	
Input Voltage Range	$V_{IN}$		Full	1.7		7.5	V	
Output Voltage Accuracy	$V_{OUT}$	$V_{IN} = (V_{OUT(NOM)} + 1.0V)$ to 7.5V	$+25^{\circ}C$	-1.2		1.2	%	
Maximum Output Current <sup>(1)</sup>			$+25^{\circ}C$	250			mA	
Current Limit	$I_{LIM}$		$+25^{\circ}C$	280	480		mA	
Supply Pin Current	$I_Q$	No load	Full		1.0	1.5	$\mu A$	
Dropout Voltage <sup>(2)</sup>	$V_{DROP}$	$I_{OUT} = 100mA$	$1.8V \leq V_{OUT(NOM)} < 2.5V$	$+25^{\circ}C$		145	200	mV
			$2.5V \leq V_{OUT(NOM)} < 3.3V$	$+25^{\circ}C$		100	130	
			$3.3V \leq V_{OUT(NOM)} < 4.2V$	$+25^{\circ}C$		85	110	
			$4.2V \leq V_{OUT(NOM)} < 5.2V$	$+25^{\circ}C$		75	100	
Line Regulation	$\frac{\Delta V_{OUT}}{\Delta V_{IN} \times V_{OUT}}$	$V_{IN} = (V_{OUT(NOM)} + 1.0V)$ to 7.5V	$+25^{\circ}C$		0.002	0.1	%/V	
Load Regulation	$\Delta V_{OUT}$	$I_{OUT} = 0.1mA$ to 250mA	$+25^{\circ}C$		3	15	mV	
Short Current Limit	$I_{SHORT}$	$V_{OUT} = 0V$	$+25^{\circ}C$		100		mA	
Reverse Leakage Current	$I_{RL}$	$V_{IN} = 1.7V$ , $V_{OUT} = 5.5V$	$+25^{\circ}C$		0.4		$\mu A$	
Power Supply Rejection Ratio	PSRR	$I_{OUT} = 30mA$ , $V_{OUT} = 1.8V$ , $\Delta V_{RIPPLE} = 0.2V_{P-P}$	$f = 217Hz$	$+25^{\circ}C$		38	dB	
			$f = 1kHz$	$+25^{\circ}C$		27		
Output Voltage Temperature Coefficient <sup>(3)</sup>	$\frac{\Delta V_{OUT}}{\Delta T_A \times V_{OUT}}$		Full		18		ppm/ $^{\circ}C$	
Thermal Shutdown Temperature	$T_{SHDN}$				165		$^{\circ}C$	
Thermal Shutdown Hysteresis	$\Delta T_{SHDN}$				30		$^{\circ}C$	

## NOTES:

- Maximum output current is affected by the PCB layout, size of metal trace, the thermal conduction path between metal layers, ambient temperature and the other environment factors of system. Attention should be paid to the dropout voltage when  $V_{IN} < (V_{OUT} + V_{DROP})$ .
- Dropout voltage is characterized when  $V_{OUT}$  falls 5% below  $V_{OUT(NOM)}$ .
- Output voltage temperature coefficient is defined as the worst-case voltage change divided by the total temperature range.

**TYPICAL PERFORMANCE CHARACTERISTICS**

$T_A = +25^\circ\text{C}$ ,  $V_{IN} = V_{OUT(NOM)} + 1.0\text{V}$ ,  $C_{IN} = 1\mu\text{F}$ ,  $C_{OUT} = 0.1\mu\text{F}$ , unless otherwise noted.

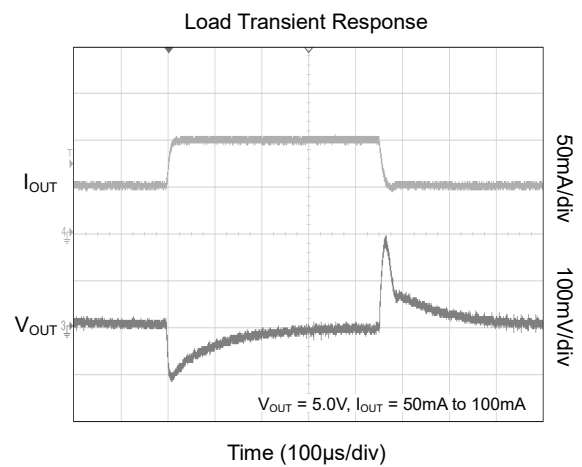
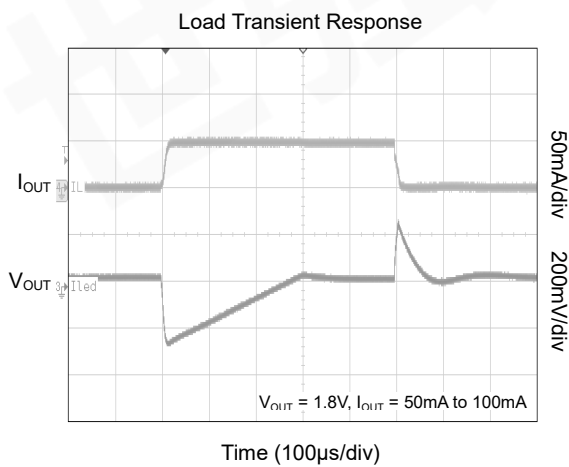
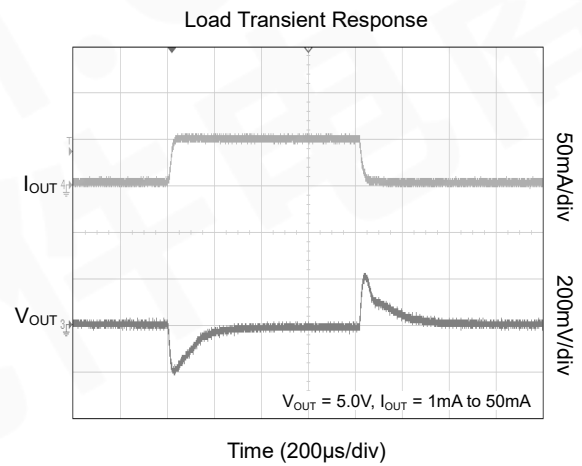
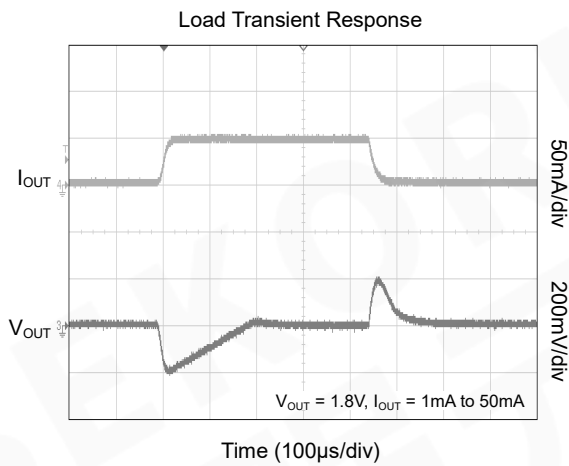
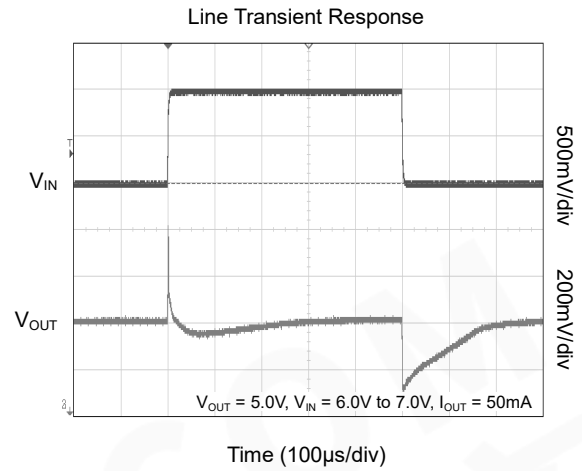
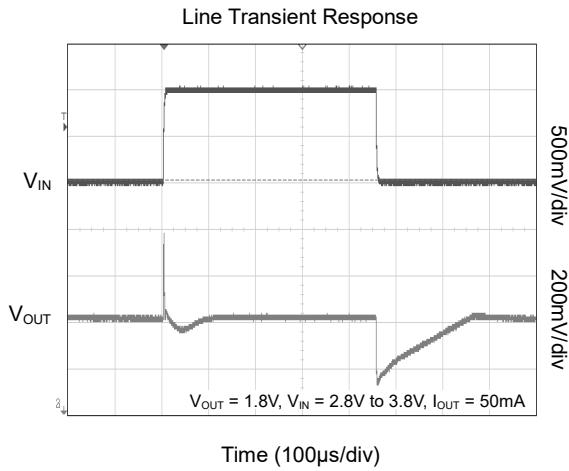

TYPICAL PERFORMANCE CHARACTERISTICS (continued)

$T_A = +25^\circ\text{C}$ ,  $V_{IN} = V_{OUT(NOM)} + 1.0\text{V}$ ,  $C_{IN} = 1\mu\text{F}$ ,  $C_{OUT} = 0.1\mu\text{F}$ , unless otherwise noted.

Power-Up Output Waveform

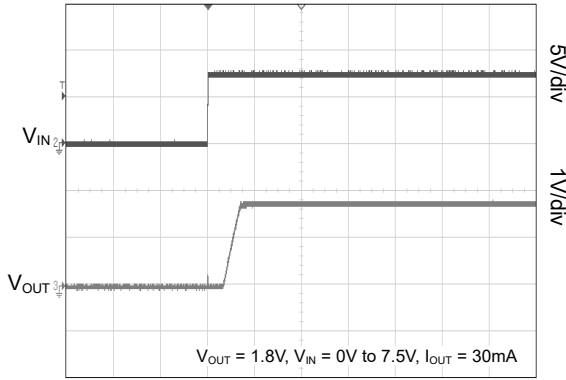

Time (5ms/div)

Power-Up Output Waveform

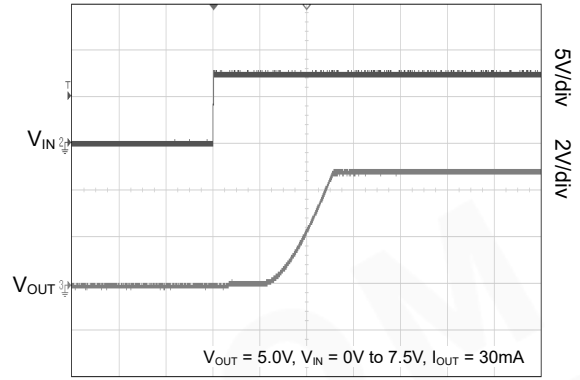

Time (5ms/div)

Power Supply Rejection Ratio vs. Frequency

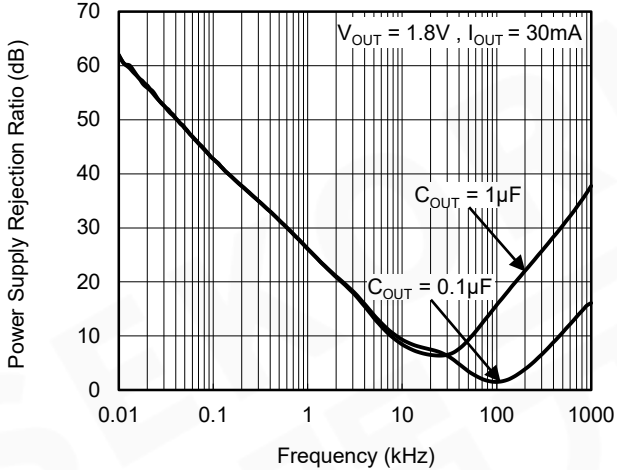

Power Supply Rejection Ratio vs. Frequency

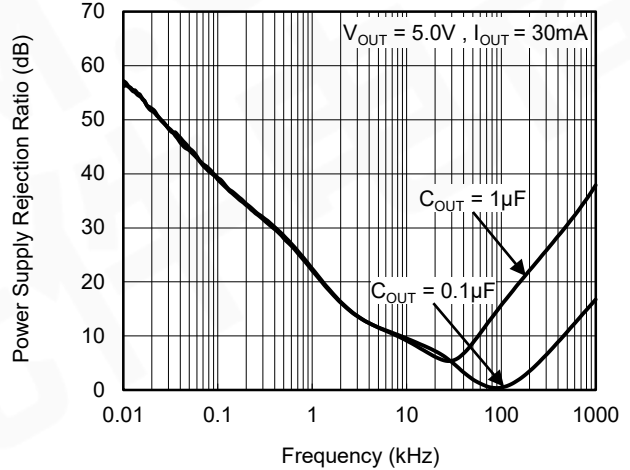

Dropout Voltage vs. Output Current

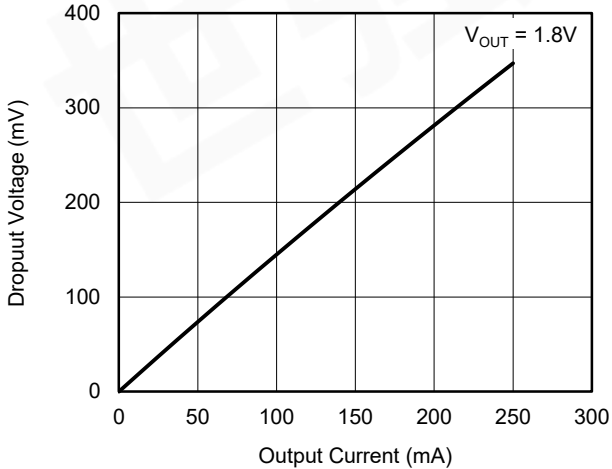

Dropout Voltage vs. Output Current

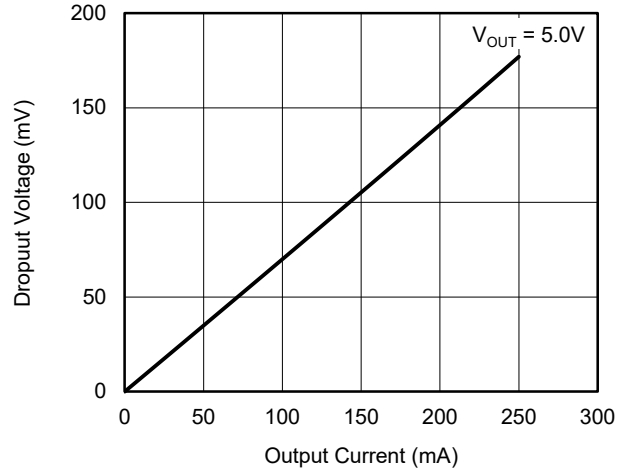

TYPICAL PERFORMANCE CHARACTERISTICS (continued)

$T_A = +25^\circ\text{C}$ ,  $V_{IN} = V_{OUT(NOM)} + 1.0\text{V}$ ,  $C_{IN} = 1\mu\text{F}$ ,  $C_{OUT} = 0.1\mu\text{F}$ , unless otherwise noted.

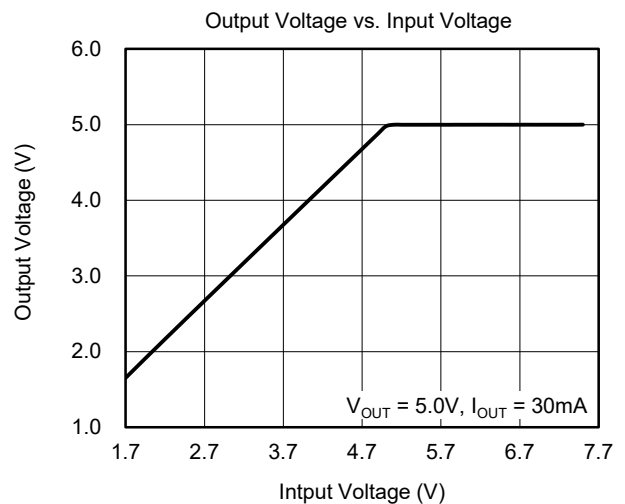
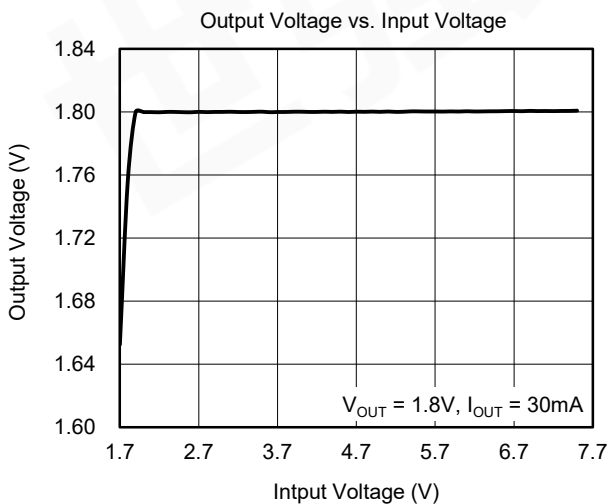
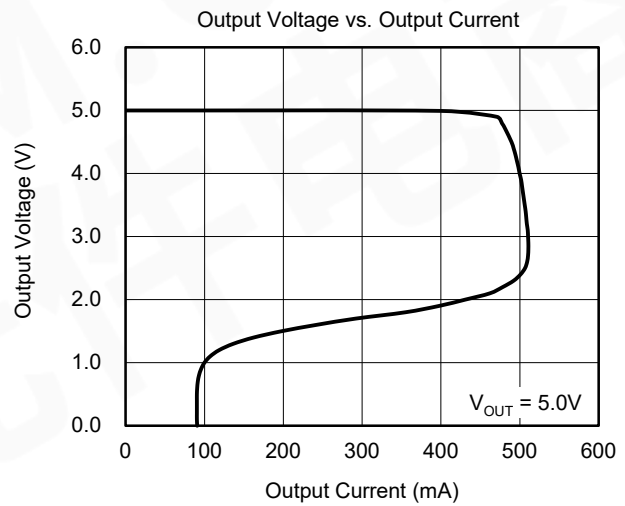
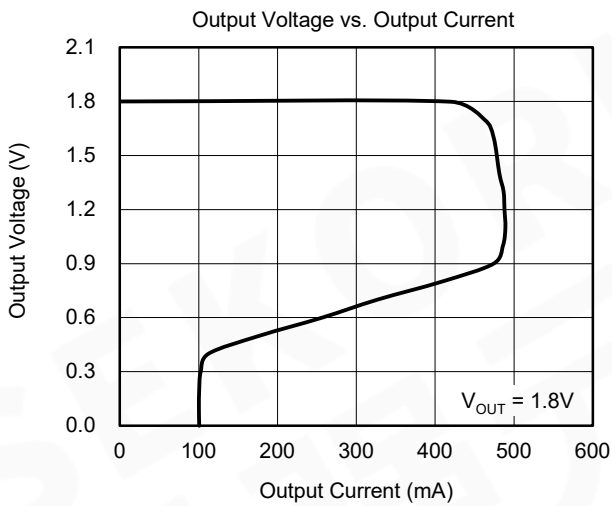
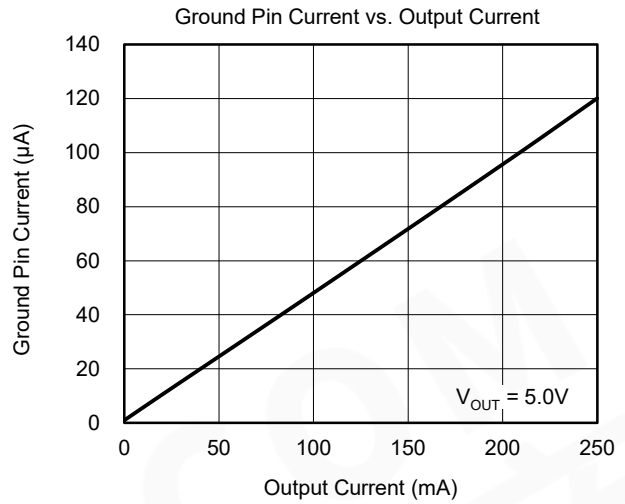
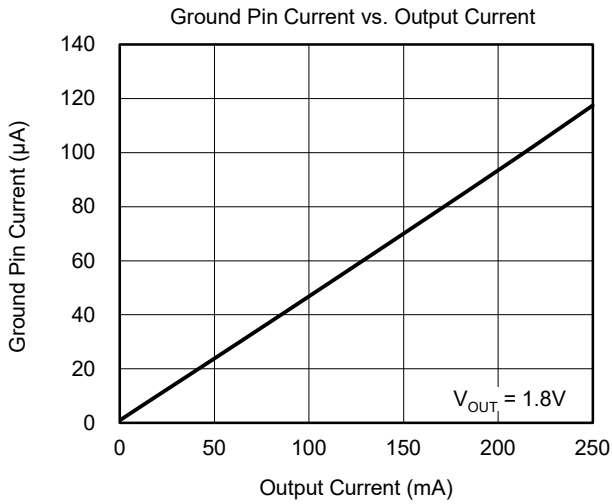

TYPICAL PERFORMANCE CHARACTERISTICS (continued)

$T_A = +25^\circ\text{C}$ ,  $V_{IN} = V_{OUT(NOM)} + 1.0\text{V}$ ,  $C_{IN} = 1\mu\text{F}$ ,  $C_{OUT} = 0.1\mu\text{F}$ , unless otherwise noted.

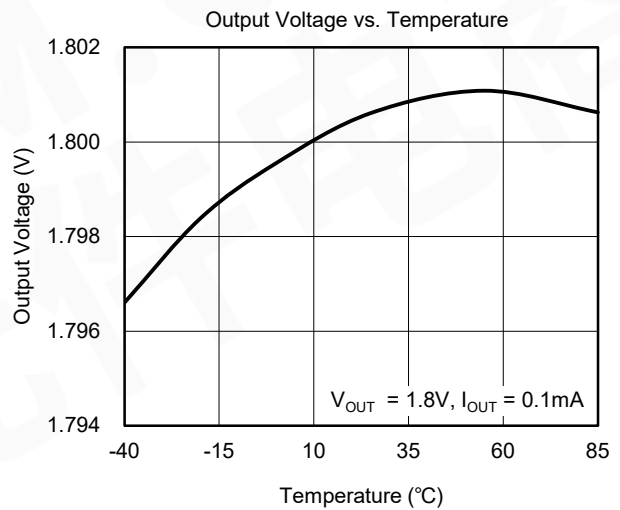
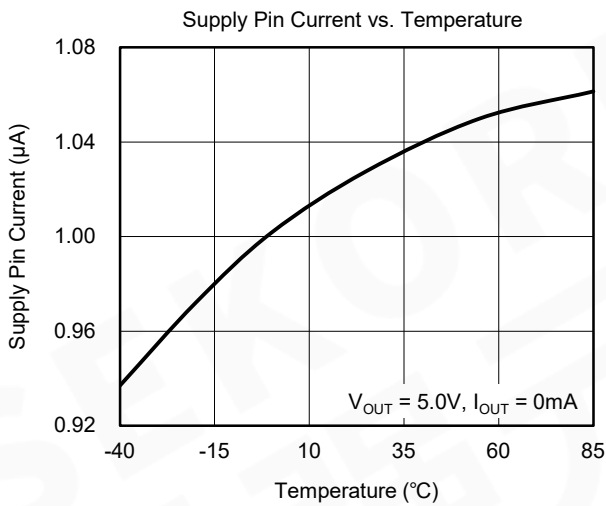
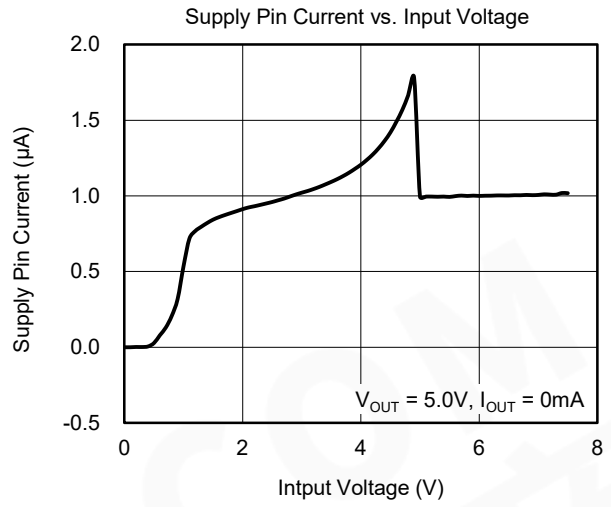
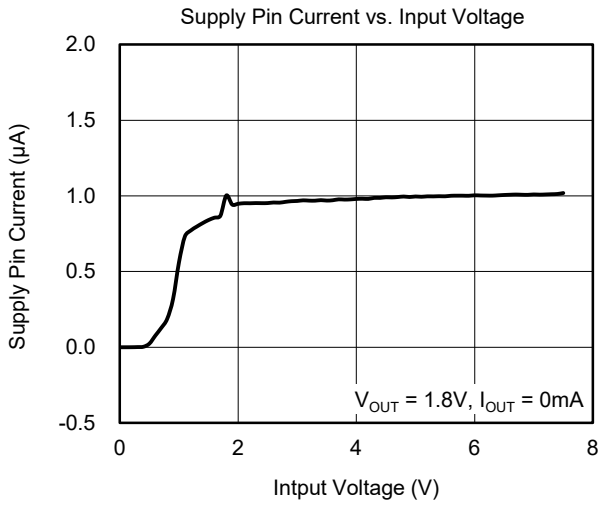



FUNCTIONAL BLOCK DIAGRAM

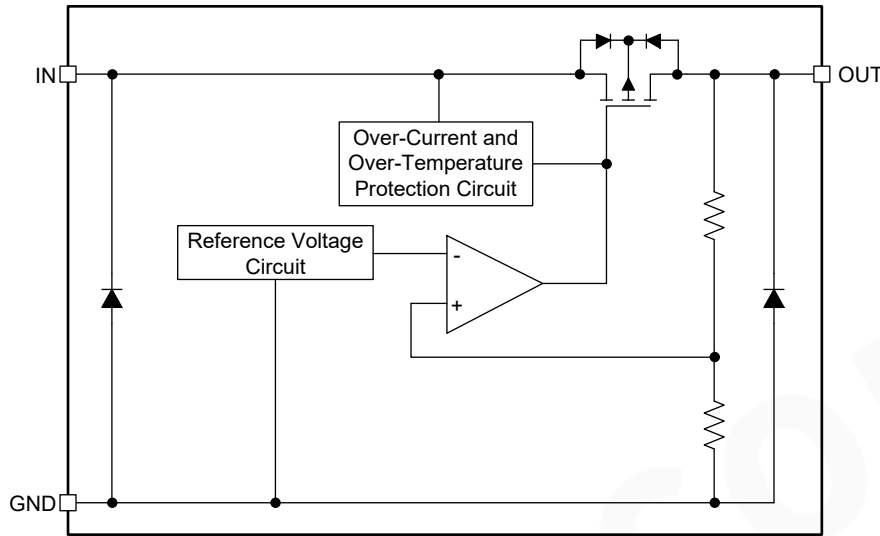

Figure 1. Block Diagram

APPLICATION INFORMATION

Standard Circuit

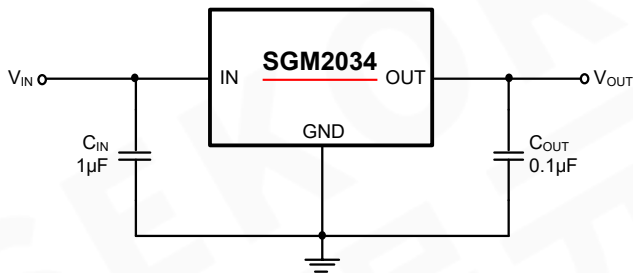

Figure 2. Standard Circuit

Conditions of Application

Input Capacitor ( $C_{IN}$ ): 1µF or higher  
 Output Capacitor ( $C_{OUT}$ ): 0.1µF or higher

Caution: Generally regulator may oscillate depending on the selection of external components.

Confirm that no oscillation occurs in the application for which the above capacitors are used.

Selection of Input and Output Capacitors

The SGM2034 series require an output capacitor ( $C_{OUT}$ ) between the OUT pin and GND pin for phase compensation.

Operation is stable with a ceramic capacitor of 0.1µF or higher in the entire temperature range. When using an OS capacitor, a tantalum capacitor, or an aluminum

electrolytic capacitor, the capacitance must be 0.1µF or higher.

The value of the output overshoot or undershoot transient response varies depending on the value of the output capacitor.

The required capacitance of the input capacitor ( $C_{IN}$ ) differs depending on the application.

The recommended value for an application is  $C_{IN} \geq 1\mu F$ ,  $C_{OUT} \geq 0.1\mu F$ ; however, when selecting these capacitors, perform sufficient evaluation, including evaluation of temperature characteristics, on the actual device.

The SGM2034 series enable use of a low equivalent series resistance capacitor, such as a ceramic capacitor, for the output-side capacitor ( $C_{OUT}$ ).

Over-Current Protection Circuit

The SGM2034 series include an over-current protection circuit having the characteristics shown in the table of Electrical Characteristics, in order to protect the output transistor against an excessive output current and short circuiting between the OUT and GND pins. The current when the output pin is short circuited ( $I_{SHORT}$ ) is internally set at approximately 100mA (TYP), and the normal value is restored for the output voltage, if the short circuit condition is released.

**REVISION HISTORY**

NOTE: Page numbers for previous revisions may differ from page numbers in the current version.

**Changes from Original (DECEMBER 2018) to REV.A**

---

Changed from product preview to production data.....All

---

SEKORM.COM  
世强元件电商

PACKAGE OUTLINE DIMENSIONS

SOT-23-3

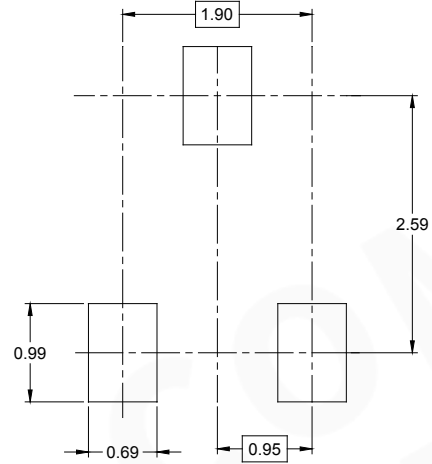
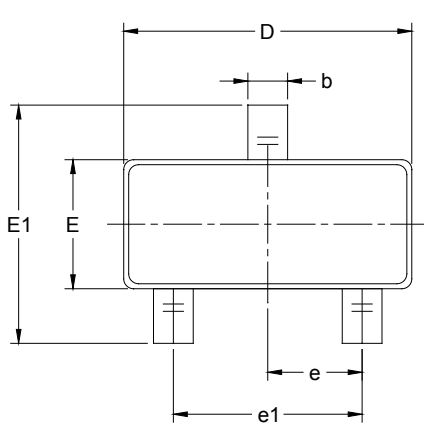

RECOMMENDED LAND PATTERN (Unit: mm)

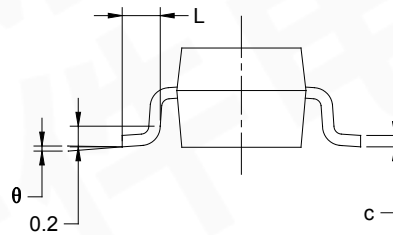
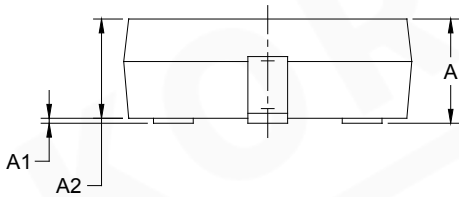

Symbol	Dimensions In Millimeters		Dimensions In Inches	
	MIN	MAX	MIN	MAX
A	1.050	1.250	0.041	0.049
A1	0.000	0.100	0.000	0.004
A2	1.050	1.150	0.041	0.045
b	0.300	0.500	0.012	0.020
c	0.100	0.200	0.004	0.008
D	2.820	3.020	0.111	0.119
E	1.500	1.700	0.059	0.067
E1	2.650	2.950	0.104	0.116
e	0.950 BSC		0.037 BSC	
e1	1.900 BSC		0.075 BSC	
L	0.300	0.600	0.012	0.024
$\theta$	0°	8°	0°	8°

PACKAGE OUTLINE DIMENSIONS

SOT-89-3

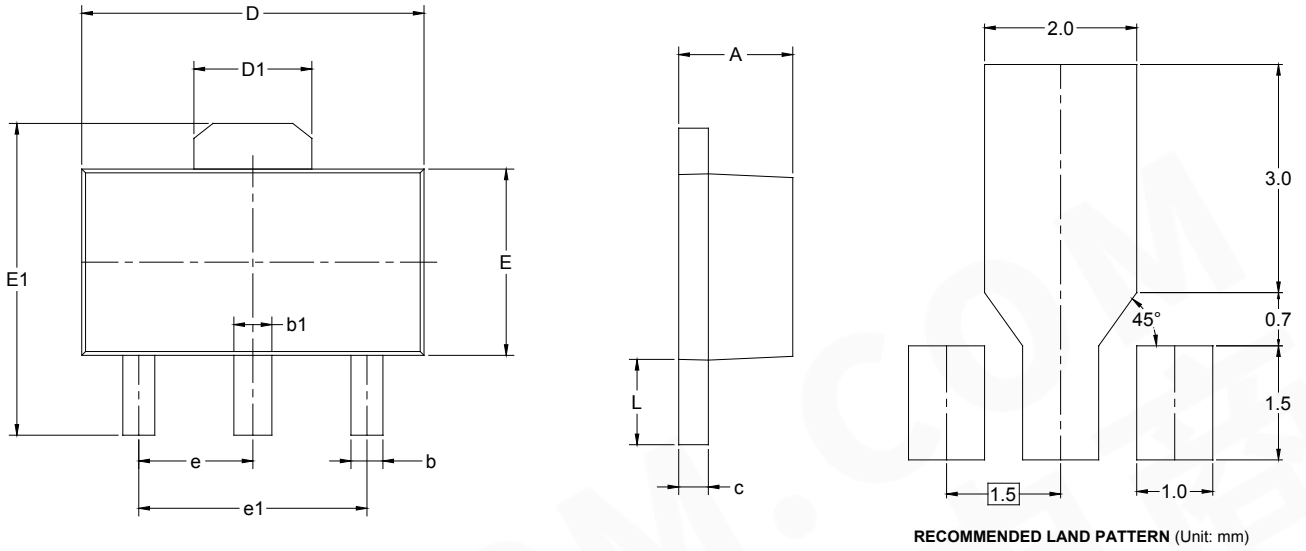

Symbol	Dimensions In Millimeters		Dimensions In Inches	
	MIN	MAX	MIN	MAX
A	1.400	1.600	0.055	0.063
b	0.320	0.520	0.013	0.020
b1	0.400	0.580	0.016	0.023
c	0.350	0.440	0.014	0.017
D	4.400	4.600	0.173	0.181
D1	1.550 REF		0.061 REF	
E	2.300	2.600	0.091	0.102
E1	3.940	4.250	0.155	0.167
e	1.500 TYP		0.060 TYP	
e1	3.000 TYP		0.118 TYP	
L	0.900	1.200	0.035	0.047

# PACKAGE INFORMATION

## TAPE AND REEL INFORMATION

### REEL DIMENSIONS



### TAPE DIMENSIONS

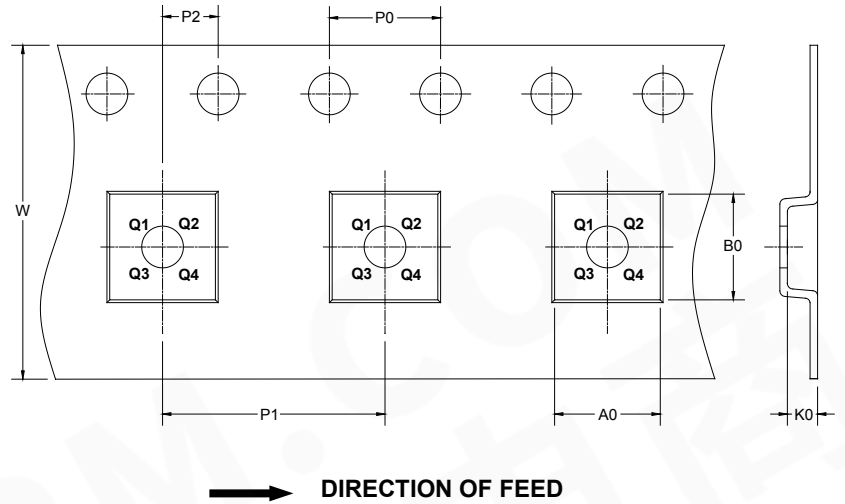

NOTE: The picture is only for reference. Please make the object as the standard.

### KEY PARAMETER LIST OF TAPE AND REEL

Package Type	Reel Diameter	Reel Width W1 (mm)	A0 (mm)	B0 (mm)	K0 (mm)	P0 (mm)	P1 (mm)	P2 (mm)	W (mm)	Pin1 Quadrant
SOT-23-3	7"	9.0	3.20	3.30	1.30	4.0	4.0	2.0	8.0	Q3
SOT-89-3	7"	13.2	4.85	4.45	1.85	4.0	8.0	2.0	12.0	Q3

DD0001

# PACKAGE INFORMATION

## CARTON BOX DIMENSIONS



NOTE: The picture is only for reference. Please make the object as the standard.

## KEY PARAMETER LIST OF CARTON BOX

Reel Type	Length (mm)	Width (mm)	Height (mm)	Pizza/Carton
7" (Option)	368	227	224	8
7"	442	410	224	18

DD0002