

THIS DRAWING IS UNPUBLISHED. RELEASED FOR PUBLICATION 20
 © COPYRIGHT 20 BY Tyco Electronics Japan G.K. ALL RIGHTS RESERVED.

LOC	DIST	REVISIONS					
		P	LTR	DESCRIPTION	DATE	DWN	APVD
J	-		B	REVISED	18DEC2012	H.M	N.Y

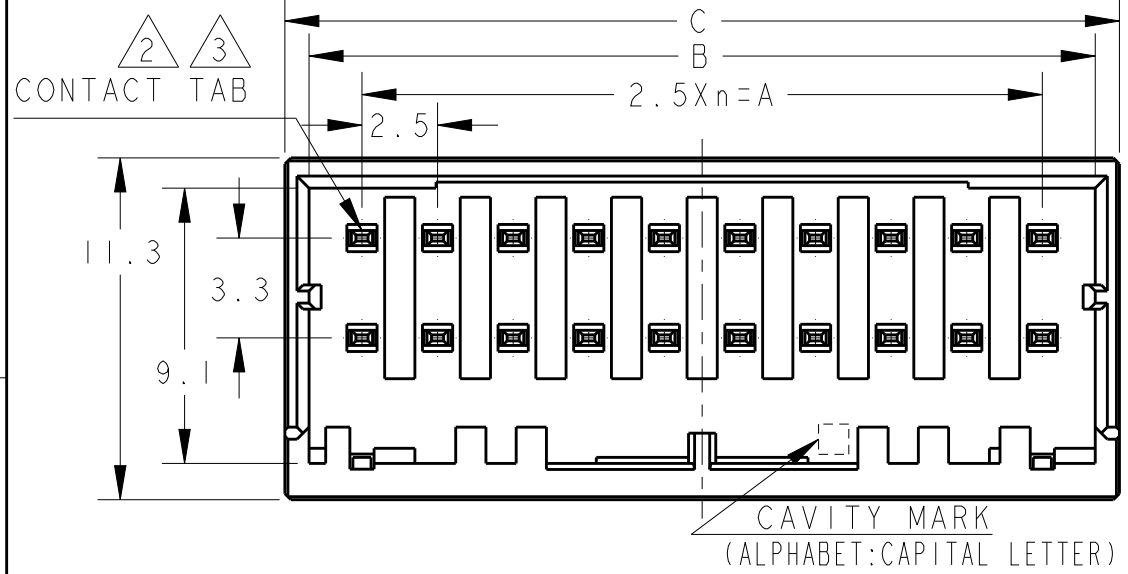

1. 材料:ハウジング:ガラス入り熱可塑性ポリエステル樹脂(94V-0)、色:黒
 コンタクト:銅合金
 リテンションレグ:錫めっき銅合金
2. めっき:全面:ニッケル下地めっき1.27μm以上
3. めっき:接触部 2の上に金めっき0.38μm以上
4. めっき:コンタクト半田付部 2の上に錫めっき2μm以上
5. 文字の形状、大きさ、および位置については、大略を示すものであり、詳細を示すものではありません。
6. Y KEY形状は、X KEY形状と左右対称

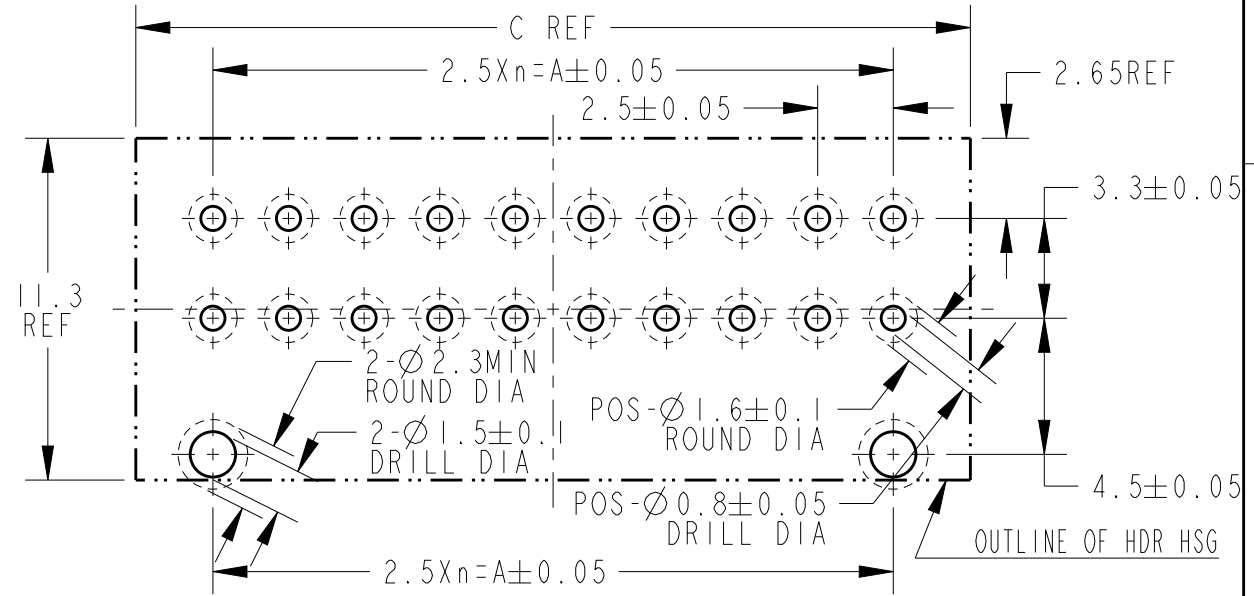

推奨基板取付穴寸法:コネクタ搭載面(非累積公差)
 PC基板厚:1.0~1.6±0.1
 RECOMMEND PC BOARD HOLE PATTERN
 : CONNECTOR MOUNT SIDE(NOT ACCUMULATE TOLERANCE)
 PC BOARD THICKNESS : 1.0~1.6±0.1

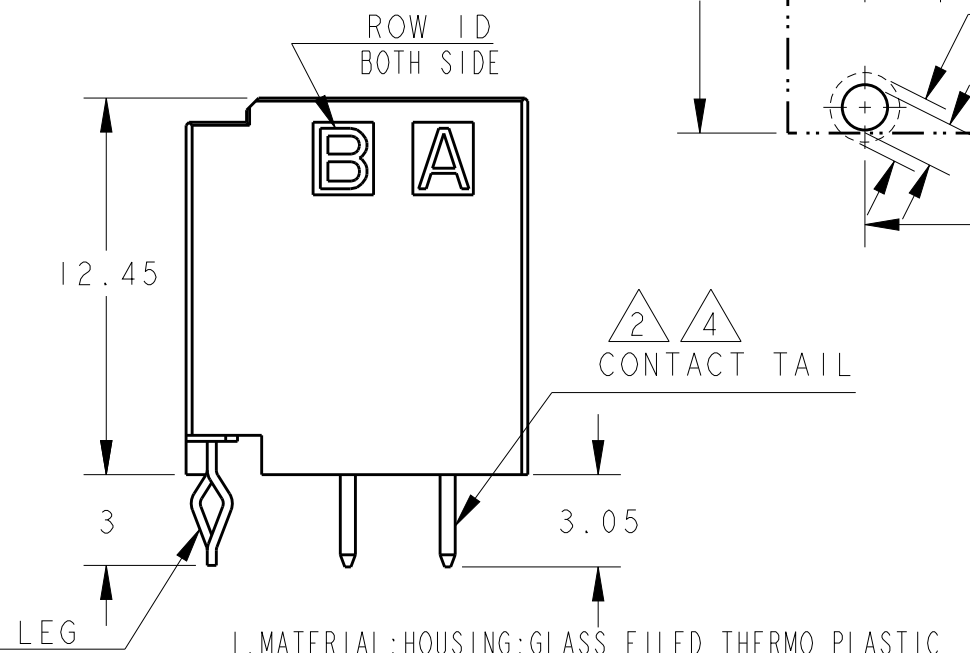
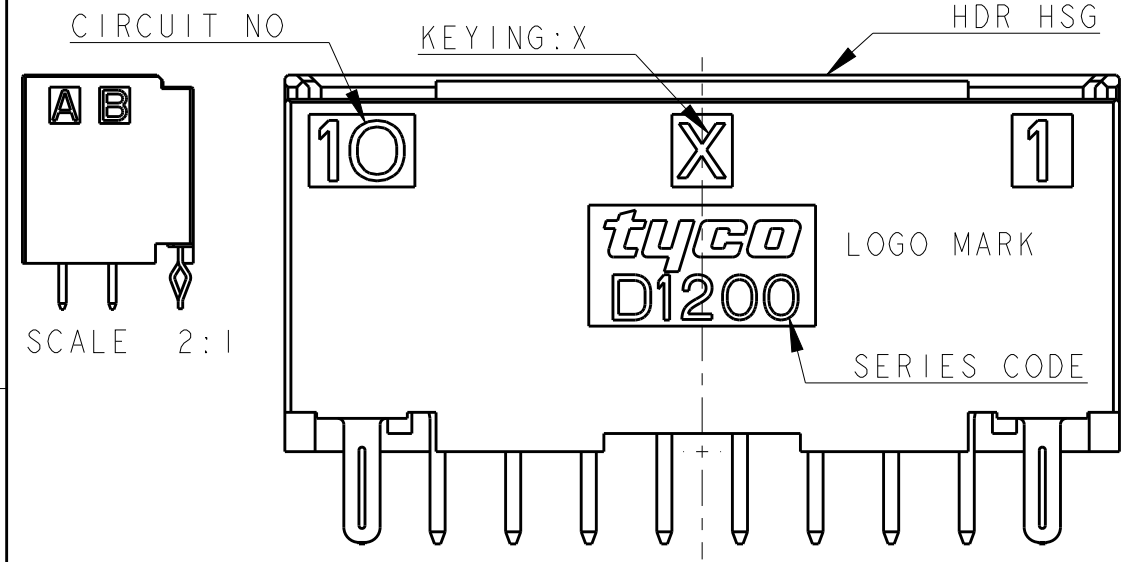

1. MATERIAL:HOUSING:GLASS FILED THERMO PLASTIC POLYESTER(94V-0),COLOR:BLACK
 CONTACT:COPPER ALLOY
 RETENTION LEG:PRE-TIN COPPER ALLOY
2. FINISH(ALL OVER):NICKEL PL. 1.27μmMIN
3. FINISH(CONTACT AREA):GOLD PL. 0.38μmMIN AFTER 2
4. FINISH(CONTACT TAIL):TIN PL. 2μmMIN AFTER 2
5. THE SHAPE, SIZE AND POSITION OF THE CHARACTER SHOW THE OUTLINE. THEY DON'T SHOW DETAILS.
6. THE KEYING ARRANGEMENT OF "Y" IS SYMMETRIC WITH "X".

POS	KEY	n	A	B	C	PART NO
20	Y	9	22.5	26.0	27.6	2-1827875-0
20	X	9	22.5	26.0	27.6	1-1827875-0
16	Y	7	17.5	21.0	22.6	2-1827875-8
16	X	7	17.5	21.0	22.6	1-1827875-8
12	Y	5	12.5	16.0	17.6	2-1827875-6
12	X	5	12.5	16.0	17.6	1-1827875-6
10	Y	4	10.0	13.5	15.1	2-1827875-5
10	X	4	10.0	13.5	15.1	1-1827875-5
8	Y	3	7.5	11.0	12.6	2-1827875-4
8	X	3	7.5	11.0	12.6	1-1827875-4
6	Y	2	5.0	8.5	10.1	2-1827875-3
6	X	2	5.0	8.5	10.1	1-1827875-3
4	Y	1	2.5	6.0	7.6	2-1827875-2
4	X	1	2.5	6.0	7.6	1-1827875-2

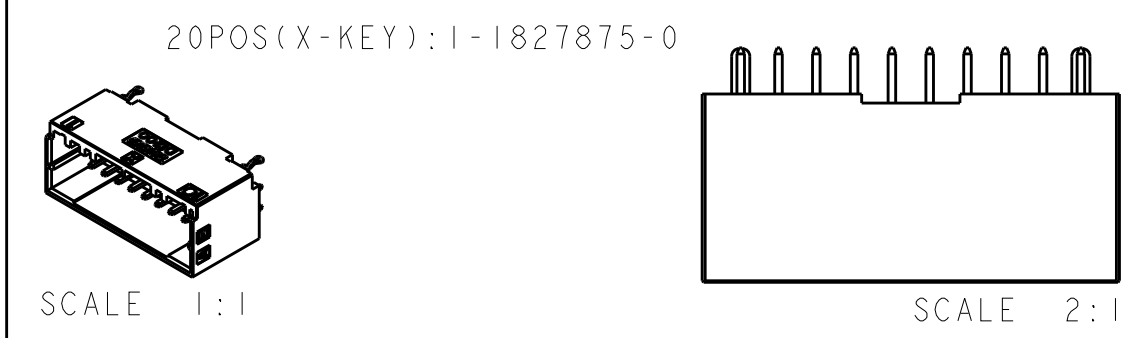
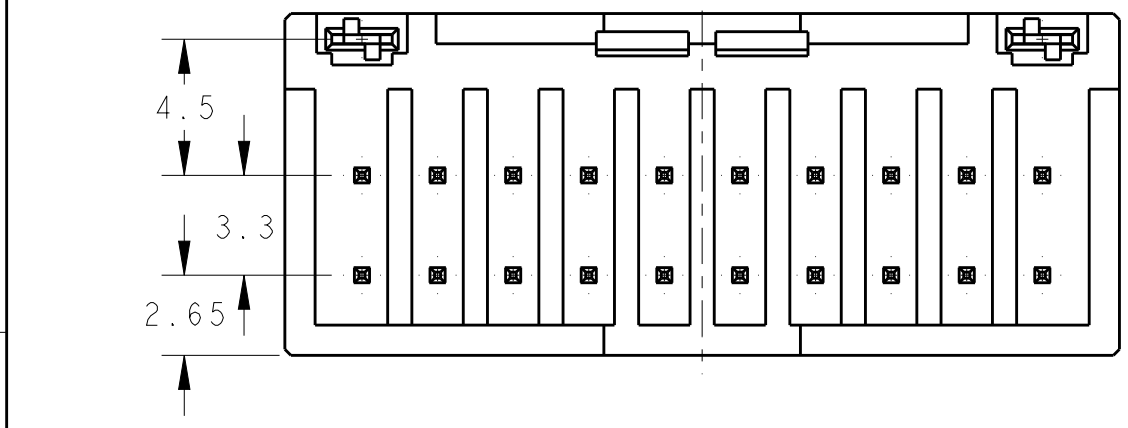

THIS DRAWING IS A CONTROLLED DOCUMENT.

DIMENSIONS: 単位: 規 mm	TOLERANCES UNLESS OTHERWISE SPECIFIED: 一般公差 ±0.3, ±5° 0 PLC ± 1 PLC ±0.5 2 PLC ±0.13 3 PLC ±0.013 4 PLC ±0.0001 ANGLES ±	DWN T. KUDO 14JAN2005 CHK D. MITSUGI 14JAN2005 APVD D. MITSUGI 14JAN2005	TE Connectivity NAME 名称 DYNAMIC D1200D 2.5mmPITCH HDR ASSY (V-TYPE) 4-20POS
MATERIAL 材料 &material	FINISH 仕上 -	PRODUCT SPEC 108-78268 APPLICATION SPEC 114-5377 WEIGHT -	

CUSTOMER DRAWING SCALE 4:1 SHEET 1 OF 3 REV B

THIS DRAWING IS UNPUBLISHED. RELEASED FOR PUBLICATION
 © COPYRIGHT 20 BY Tyco Electronics Japan G.K. ALL RIGHTS RESERVED.

LOC	DIST	REVISIONS					
		P	LTR	DESCRIPTION	DATE	DWN	APVD
J	-			SEE SHEET 1 OF 3			

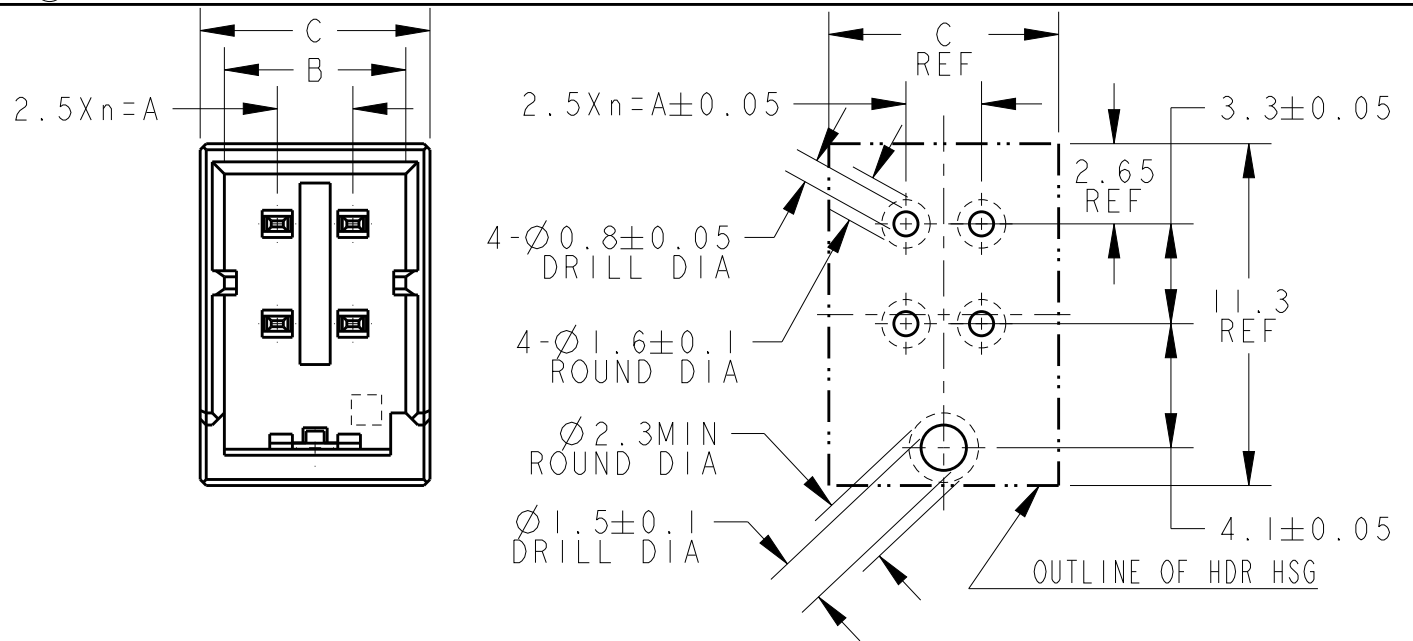

推奨基板取付穴寸法: コネクタ搭載面(非累積公差)
 PC基板厚: 1.0~1.6±0.1
 RECOMMEND PC BOARD HOLE PATTERN
 : CONNECTOR MOUNT SIDE(NOT ACCUMULATE TOLERANCE)
 PC BOARD THICKNESS : 1.0~1.6±0.1

ONLY 4POS

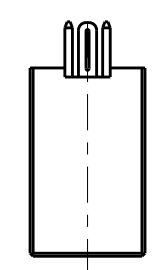
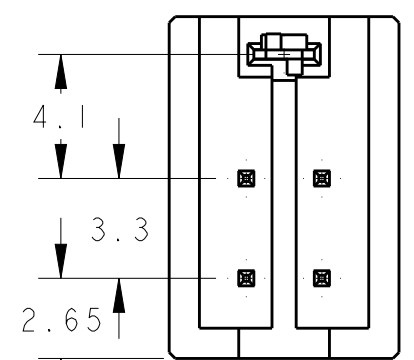
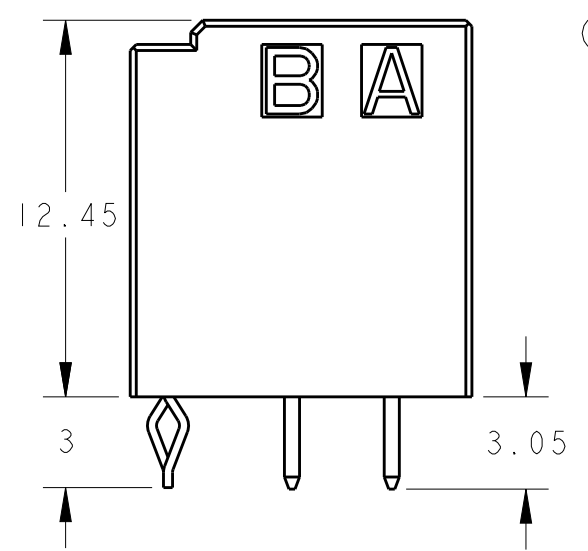
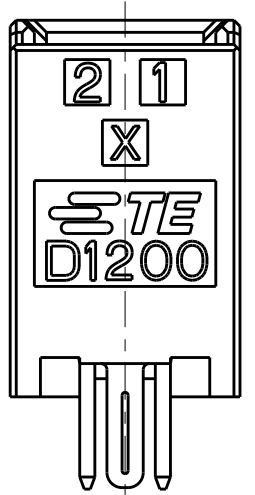

SCALE 2:1

4POS(X-KEY): 1-1827875-2

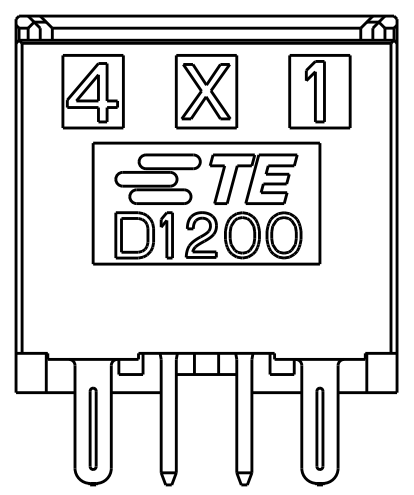
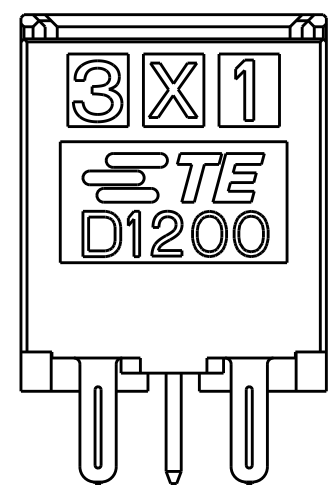
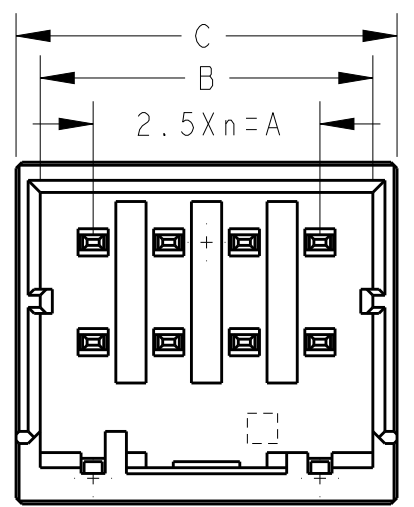
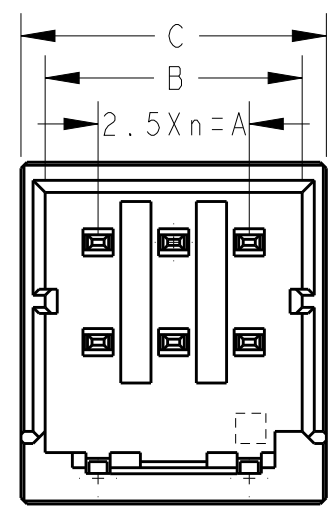

6POS(X-KEY): 1-1827875-3

8POS(X-KEY): 1-1827875-4

THIS DRAWING IS A CONTROLLED DOCUMENT.		DWN	14JAN2005	TE Connectivity	NAME DYNAMIC D1200D 2.5mmPITCH HDR ASSY (V-TYPE) 4-20POS
DIMENSIONS: mm		CHK	14JAN2005		
TOLERANCES UNLESS OTHERWISE SPECIFIED:		APVD	14JAN2005	SIZE	A3
0 PLC	±0.5	PRODUCT SPEC	108-78268	CAGE CODE	00779
1 PLC	±0.13	APPLICATION SPEC	114-5377	DRAWING NO	1827875
2 PLC	±0.013	WEIGHT	-	RESTRICTED TO	-
3 PLC	±0.0001	CUSTOMER DRAWING		SCALE	4:1
4 PLC	±			SHEET	2 OF 3
ANGLES	±			REV	B
MATERIAL	&material				

SEE SHEET 1 OF 3

THIS DRAWING IS UNPUBLISHED.

RELEASED FOR PUBLICATION

20

LOC J
DIST -

REVISIONS

© COPYRIGHT 20 BY Tyco Electronics Japan G.K. ALL RIGHTS RESERVED.

P	LTR	DESCRIPTION	DATE	DWN	APVD
		SEE SHEET 1 OF 3			

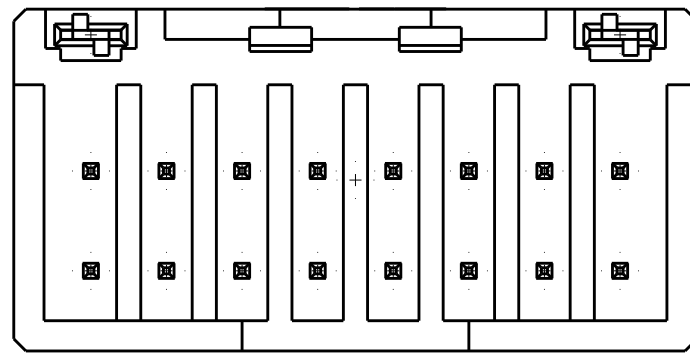
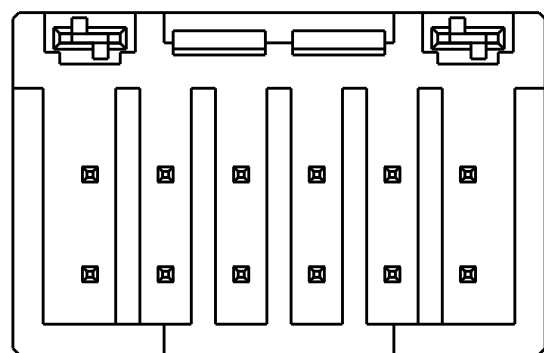
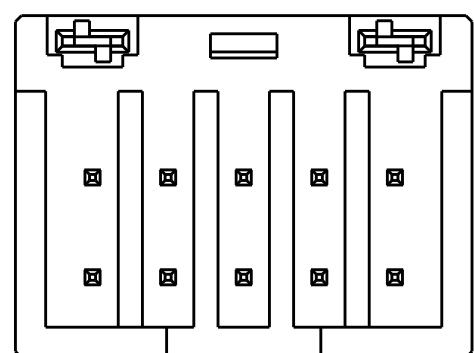
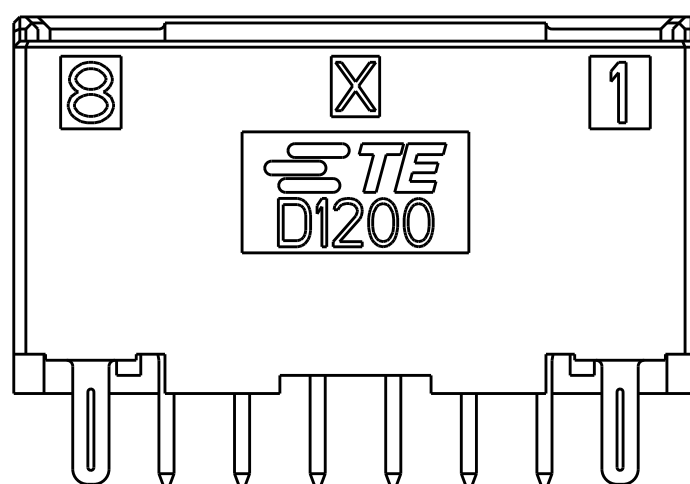
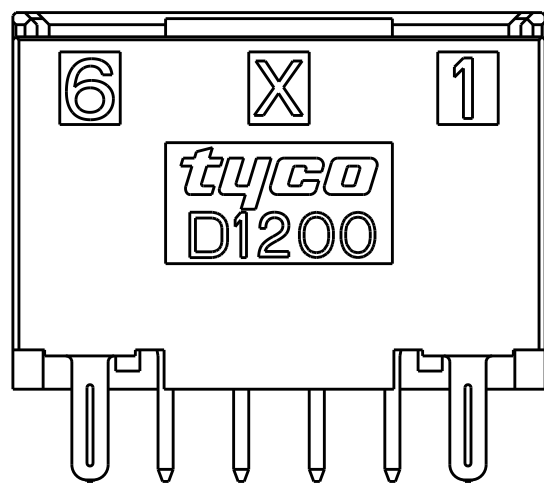
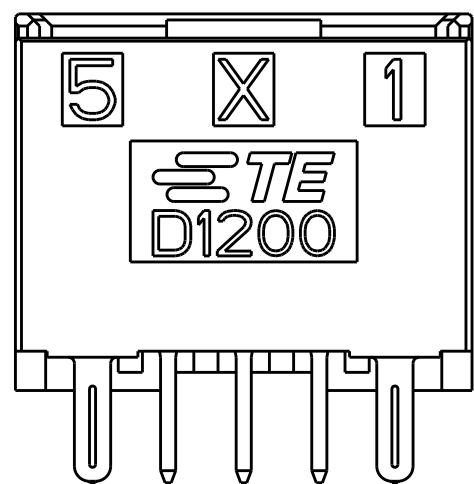
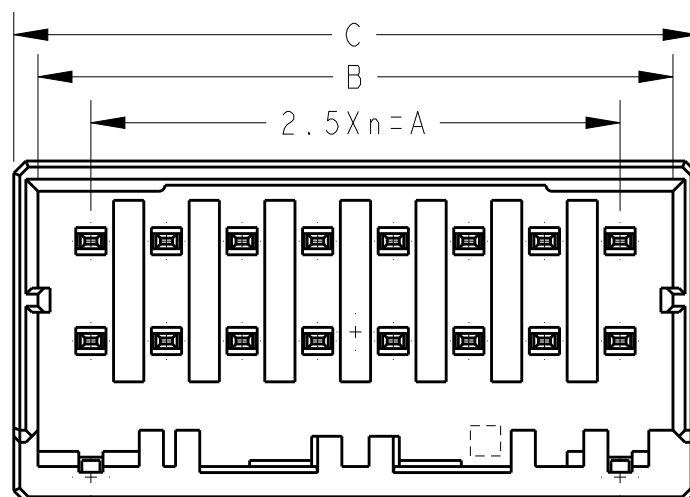
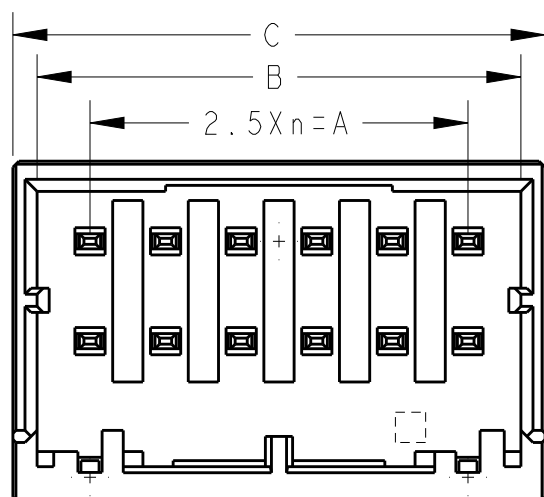
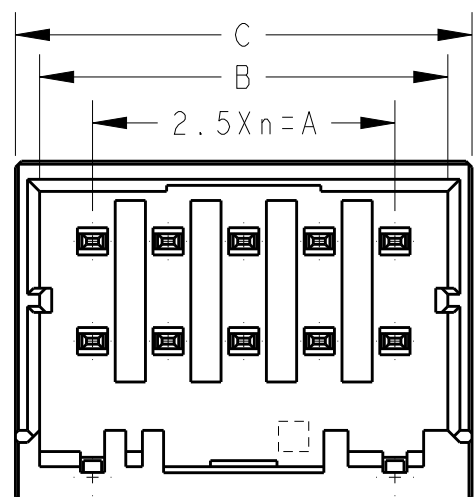

10POS(X-KEY): I-1827875-5

12POS(X-KEY): I-1827875-6

16POS(X-KEY): I-1827875-8

THIS DRAWING IS A CONTROLLED DOCUMENT.

DIMENSIONS:
mm



TOLERANCES UNLESS OTHERWISE SPECIFIED:

- 0 PLC ±0.5
- 1 PLC ±0.13
- 2 PLC ±0.13
- 3 PLC ±0.013
- 4 PLC ±0.0001
- ANGLES ±

MATERIAL &material

FINISH -

DWN T. KUDO 14JAN2005

CHK D. MITSUGI 14JAN2005

APVD D. MITSUGI 14JAN2005

PRODUCT SPEC 108-78268

APPLICATION SPEC 114-5377

WEIGHT -

CUSTOMER DRAWING



TE Connectivity

NAME DYNAMIC D1200D 2.5mmPITCH HDR ASSY (V-TYPE) 4-20POS

SIZE A3 CAGE CODE 00779 DRAWING NO. C-1827875 RESTRICTED TO -

SCALE 4:1 SHEET 3 OF 3 REV B

SEE SHEET 1 OF 3