



Features

- $V_{DS} = -20V, I_D = -5.4A$
 $R_{DS(ON)} < 60m\Omega @ V_{GS} = -2.5V$
 $R_{DS(ON)} < 45m\Omega @ V_{GS} = -4.5V$
- High power and current handling capability
- Lead free product is acquired
- Surface mount package

Application

- Motor control and drive
- Battery management
- UPS (Uninterruptible Power Supplies)

Product Summary

V_{DS}		-20	V
$R_{DS(on),typ}$	$V_{GS} = -4.5V$	45	$m\Omega$
$R_{DS(on),typ}$	$V_{GS} = -2.5V$	60	$m\Omega$
I_D		-5.4	A

top view

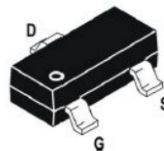

SOT-23

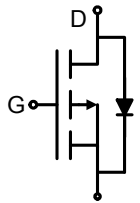
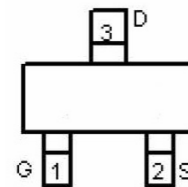

ABSOLUTE MAXIMUM RATINGS $T_A = 25^\circ C$, unless otherwise noted			
Parameter		Limit	Unit
Drain-Source Voltage	V_{DS}	- 8	V
Gate-Source Voltage	V_{GS}	± 8	
Continuous Drain Current ($T_J = 150^\circ C$)	$T_C = 25^\circ C$	- 5.4	A
	$T_C = 70^\circ C$	- 4.3	
	$T_A = 25^\circ C$	- 4.1 ^{a, b}	
	$T_A = 70^\circ C$	- 3.3 ^{a, b}	
Pulsed Drain Current	I_{DM}	- 10	
Continuous Source-Drain Diode Current	$T_C = 25^\circ C$	- 1.4	
	$T_A = 25^\circ C$	- 0.8 ^{a, b}	
Maximum Power Dissipation	$T_C = 25^\circ C$	1.7	W
	$T_C = 70^\circ C$	1.1	
	$T_A = 25^\circ C$	0.96 ^{a, b}	
	$T_A = 70^\circ C$	0.62 ^{a, b}	
Operating Junction and Storage Temperature Range	T_J, T_{stg}	- 50 to 150	$^\circ C$
Soldering Recommendations (Peak Temperature)		260	

Notes:

- Surface Mounted on 1" x 1" FR4 board.
- $t = 10s$.



THERMAL RESISTANCE RATINGS					
Parameter		Symbol	Typical	Maximum	Unit
Maximum Junction-to-Ambient ^{a, b}	$t \leq 10$ s	R_{thJA}	100	130	°C/W
Maximum Junction-to-Foot (Drain)	Steady State	R_{thJF}	60	75	

Notes:

- a. Surface Mounted on 1" x 1" FR4 board.
- b. Maximum under Steady State conditions is 175 °C/W.

SPECIFICATIONS $T_J = 25$ °C, unless otherwise noted						
Parameter	Symbol	Test Conditions	Min.	Typ.	Max.	Unit
Static						
Drain-Source Breakdown Voltage	V_{DS}	$V_{GS} = 0$ V, $I_D = -250$ μ A	-20			V
V_{DS} Temperature Coefficient	$\Delta V_{DS}/T_J$	$I_D = -250$ μ A		-55		mV/°C
$V_{GS(th)}$ Temperature Coefficient	$\Delta V_{GS(th)}/T_J$		2.1			
Gate-Source Threshold Voltage	$V_{GS(th)}$	$V_{DS} = V_{GS}$, $I_D = -250$ μ A	-0.45		-0.8	V
Gate-Source Leakage	I_{GSS}	$V_{DS} = 0$ V, $V_{GS} = \pm 8$ V			± 100	nA
Zero Gate Voltage Drain Current	I_{DSS}	$V_{DS} = -8$ V, $V_{GS} = 0$ V			-1	μ A
		$V_{DS} = -8$ V, $V_{GS} = 0$ V, $T_J = 55$ °C			-10	
On-State Drain Current ^a	$I_{D(on)}$	$V_{DS} \leq -5$ V, $V_{GS} = -4.5$ V	-5			A
Drain-Source On-State Resistance ^a	$R_{DS(on)}$	$V_{GS} = -4.5$ V, $I_D = -4.1$ A		0.032	0.040	Ω
		$V_{GS} = -2.5$ V, $I_D = -3.4$ A		0.048	0.060	
		$V_{GS} = -1.8$ V, $I_D = -2.0$ A		0.070	0.088	
Forward Transconductance ^a	g_{fs}	$V_{DS} = -5$ V, $I_D = -4.1$ A		8		S
Dynamic^b						
Input Capacitance	C_{iss}	$V_{DS} = -4$ V, $V_{GS} = 0$ V, $f = 1$ MHz		740		pF
Output Capacitance	C_{oss}		290			
Reverse Transfer Capacitance	C_{rss}		190			
Total Gate Charge	Q_g	$V_{DS} = -4$ V, $V_{GS} = -4.5$ V, $I_D = -4.1$ A		7.8	15	nC
		$V_{DS} = -4$ V, $V_{GS} = -2.5$ V, $I_D = -4.1$ A		4.5	9	
Gate-Source Charge	Q_{gs}	$V_{DS} = -4$ V, $V_{GS} = -2.5$ V, $I_D = -4.1$ A		1.2		
Gate-Drain Charge	Q_{gd}		1.6			
Gate Resistance	R_g	$f = 1$ MHz	1.4	7	14	Ω
Turn-On Delay Time	$t_{d(on)}$	$V_{DD} = -4$ V, $R_L = 1.2$ Ω $I_D \equiv -3.3$ A, $V_{GEN} = -4.5$ V, $R_g = 1$ Ω		13	20	ns
Rise Time	t_r		35	53		
Turn-Off Delay Time	$t_{d(off)}$		32	48		
Fall Time	t_f		10	20		
Turn-On Delay Time	$t_{d(on)}$	$V_{DD} = -4$ V, $R_L = 1.2$ Ω $I_D \equiv -3.3$ A, $V_{GEN} = -8$ V, $R_g = 1$ Ω		5	10	
Rise Time	t_r		11	17		
Turn-Off Delay Time	$t_{d(off)}$		22	33		
Fall Time	t_f		16	24		
Drain-Source Body Diode Characteristics						
Continuous Source-Drain Diode Current	I_S	$T_C = 25$ °C			-1.4	A
Pulse Diode Forward Current ^a	I_{SM}				-10	
Body Diode Voltage	V_{SD}	$I_F = -3.3$ A		-0.8	-1.2	V
Body Diode Reverse Recovery Time	t_{rr}	$I_F = -3.3$ A, $di/dt = 100$ A/ μ s, $T_J = 25$ °C		33	50	ns
Body Diode Reverse Recovery Charge	Q_{rr}		14	21	nC	
Reverse Recovery Fall Time	t_a		14		ns	
Reverse Recovery Rise Time	t_b		19			

Notes:

- a. Pulse test; pulse width ≤ 300 μ s, duty cycle ≤ 2 %.
- b. Guaranteed by design, not subject to production testing.

Stresses beyond those listed under "Absolute Maximum Ratings" may cause permanent damage to the device. These are stress ratings only, and functional operation of the device at these or any other conditions beyond those indicated in the operational sections of the specifications is not implied. Exposure to absolute maximum rating conditions for extended periods may affect device reliability.

TYPICAL CHARACTERISTICS 25 °C, unless otherwise noted

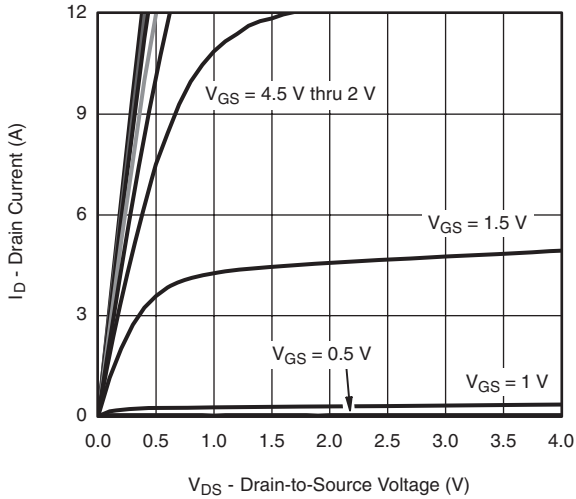

Output Characteristics

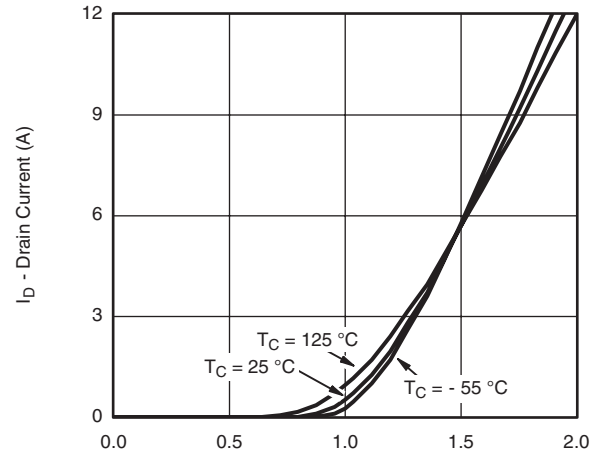

Transfer Characteristics

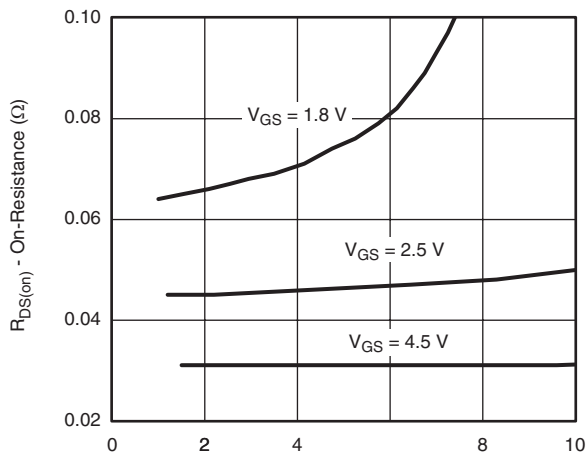

On-Resistance vs. Drain Current and Gate Voltage

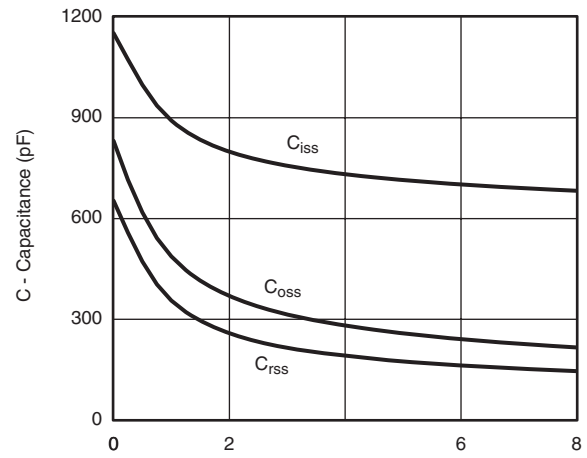

Capacitance

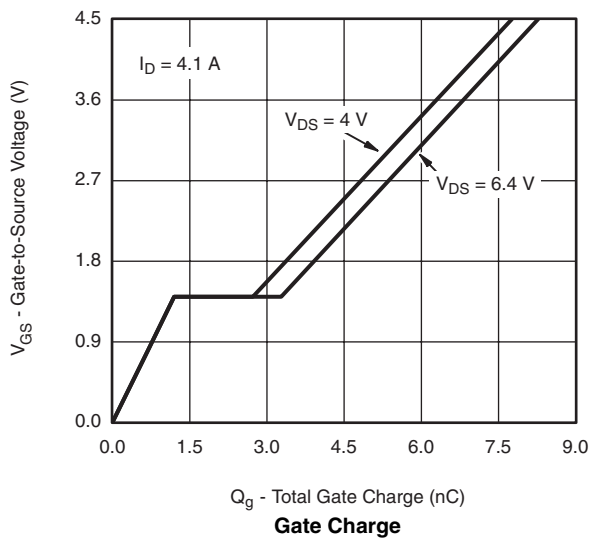

Gate Charge

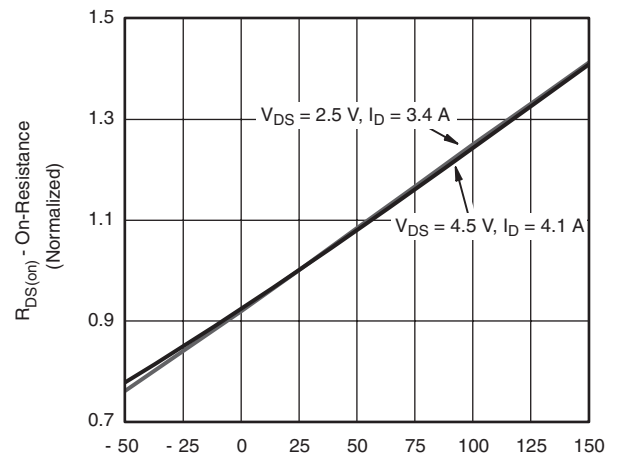

On-Resistance vs. Junction Temperature

TYPICAL CHARACTERISTICS 25 °C, unless otherwise noted

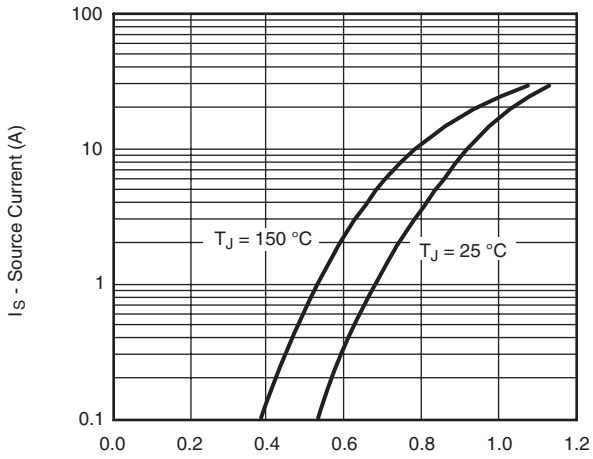

Source-Drain Diode Forward Voltage

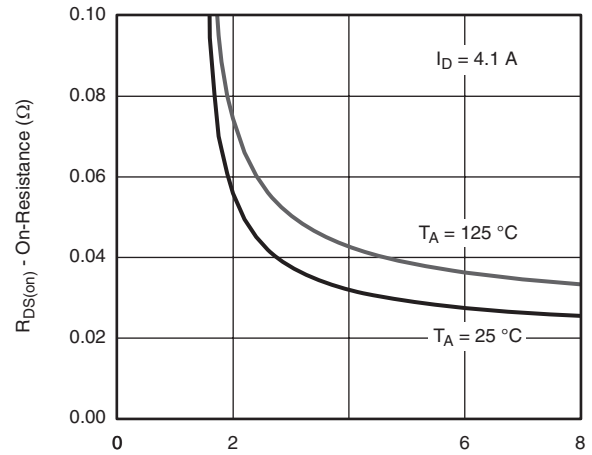

On-Resistance vs. Gate-to-Source Voltage

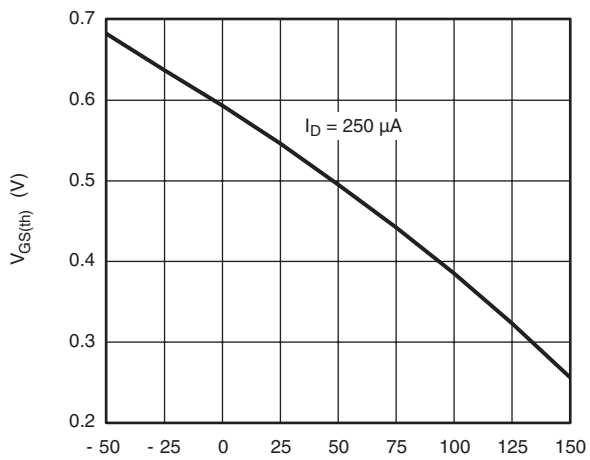

Threshold Voltage

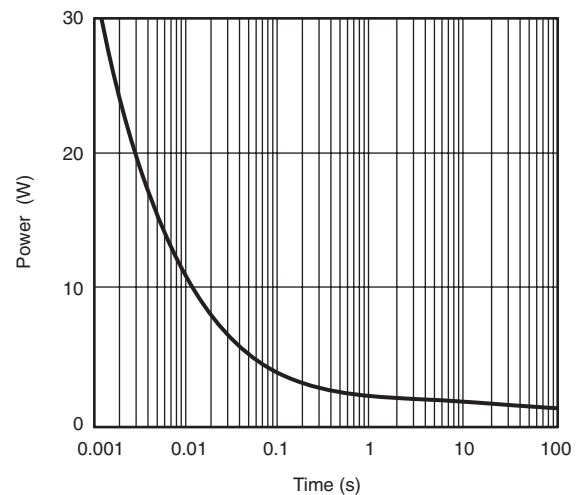

Single Pulse Power, Junction-to-Ambient

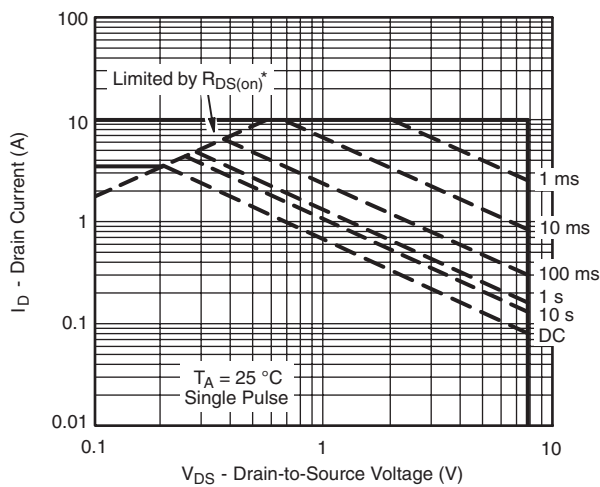

* $V_{GS} >$ minimum V_{GS} at which $R_{DS(on)}$ is specified

Safe Operating Area, Junction-to-Ambient

TYPICAL CHARACTERISTICS 25 °C, unless otherwise noted

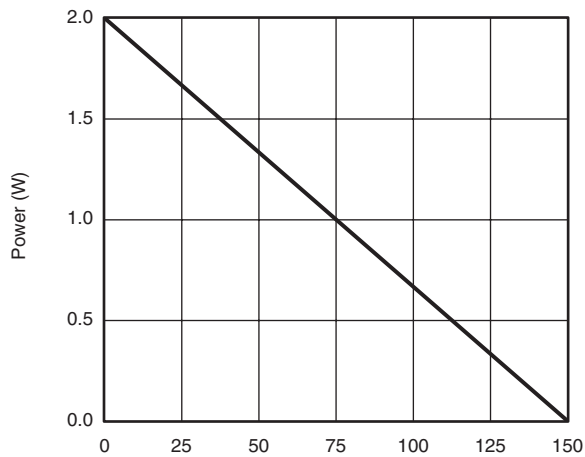
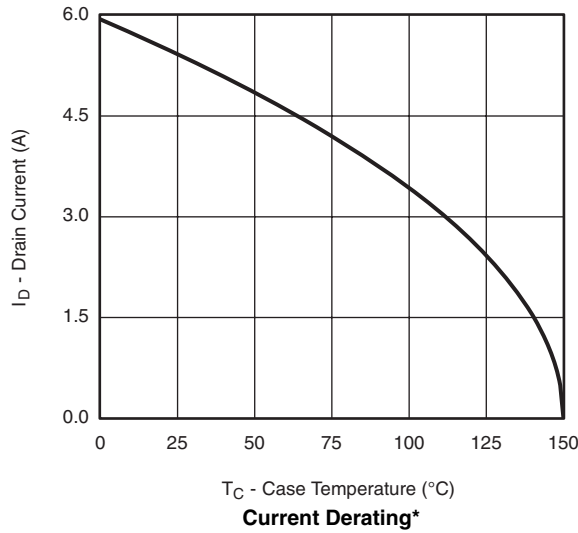

Power, Junction-to-Case

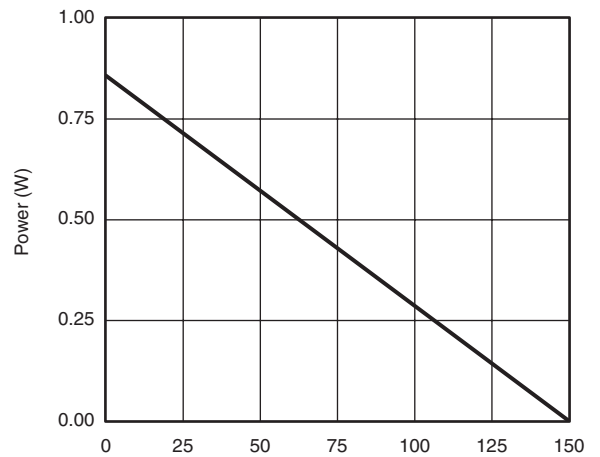

Power, Junction-to-Ambient

* The power dissipation P_D is based on $T_{J(max)} = 150$ °C, using junction-to-case thermal resistance, and is more useful in settling the upper dissipation limit for cases where additional heatsinking is used. It is used to determine the current rating, when this rating falls below the package limit.



TYPICAL CHARACTERISTICS 25 °C, unless otherwise noted

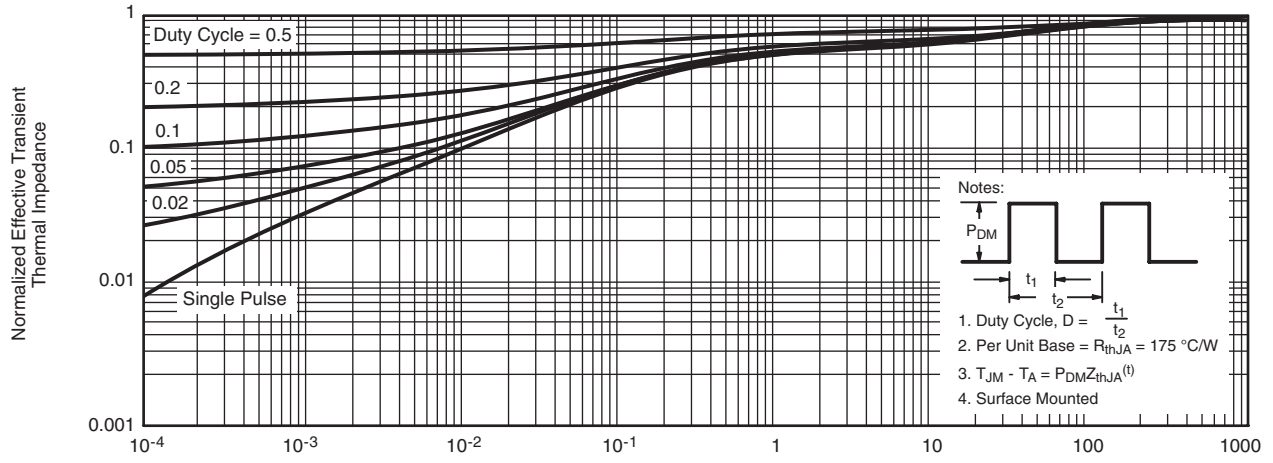

Normalized Thermal Transient Impedance, Junction-to-Ambient

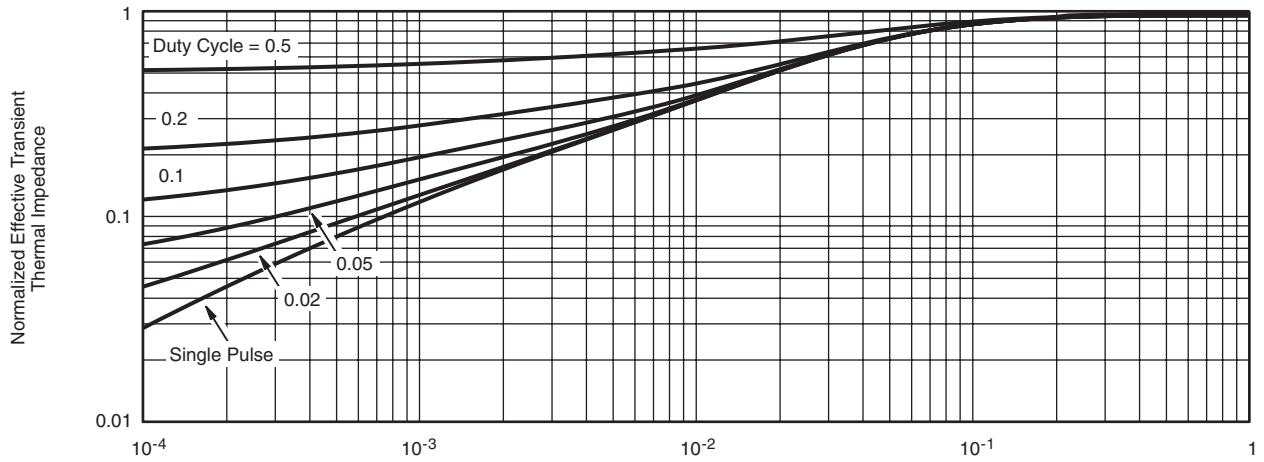

Normalized Thermal Transient Impedance, Junction-to-Foot

Ordering and Marking Information

Device	Marking	Package	Packaging	Quantity	Reel Size	Tape width
ASDM2305ZA	2305	SOT23	Tape&Reel	3000/Reel	-	-

PACKAGE	MARKING
SOT23	<div style="border: 1px solid black; width: 100px; height: 50px; margin: 0 auto; display: flex; align-items: center; justify-content: center;"> 2305 </div>

Ordering Number		Package
Lead Free	Halogen Free	
ASDM2305-ZA-R	ASDM2305G-ZA-R	SOT23

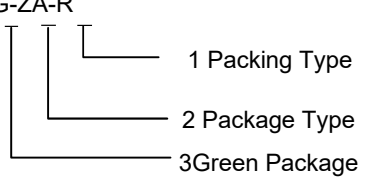
<p>ASDM2305G-ZA-R</p>  <p>1 Packing Type 2 Package Type 3 Green Package</p>	<p>1 T:Tube,R:Tape Reel 2 ZA: SOT23 3 blank : Lead Free G:Halogen Free and Lead Free</p>
--	--

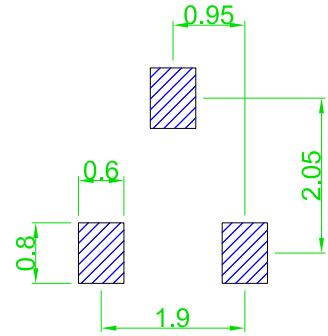
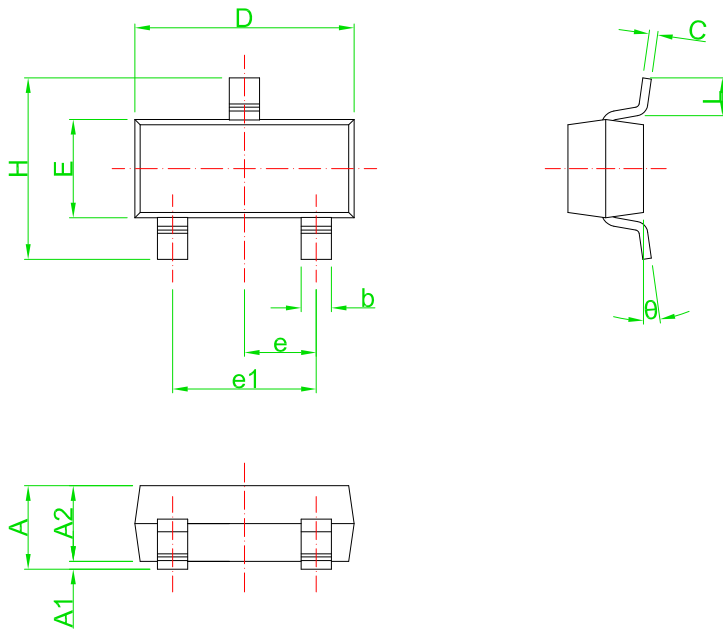

Recommended Land Pattern

Symbol	Dimensions in Millimeters		Dimensions in Inches	
	Min	Max	Min	Max
A	0.90	1.15	0.035	0.045
A1	0.00	0.10	0.000	0.004
A2	0.90	1.05	0.035	0.041
b	0.30	0.55	0.012	0.022
C	0.08	0.15	0.003	0.006
D	2.80	3.00	0.110	0.118
E	1.20	1.40	0.047	0.055
e	0.95 TYP		0.037 TYP	
e1	1.80	2.00	0.071	0.079
H	2.25	2.55	0.089	0.100
L	0.30	0.50	0.012	0.020
θ	0°	8°	0°	8°

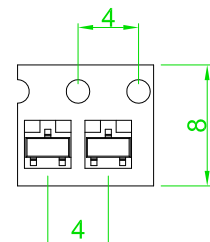

**IMPORTANT NOTICE**

Xi'an Ascend Semiconductor incorporated MAKES NO WARRANTY OF ANY KIND, EXPRESS OR IMPLIED, WITH REGARDS TO THIS DOCUMENT, INCLUDING, BUT NOT LIMITED TO, THE IMPLIED WARRANTIES OF MERCHANTABILITY AND FITNESS FOR A PARTICULAR PURPOSE (AND THEIR EQUIVALENTS UNDER THE LAWS OF ANY JURISDICTION).

Xi'an Ascend Semiconductor Incorporated and its subsidiaries reserve the right to make modifications, enhancements, improvements, corrections or other changes without further notice to this document and any product described herein. Xi'an Ascend Semiconductor Incorporated does not assume any liability arising out of the application or use of this document or any product described herein; neither does Xi'an Ascend Semiconductor Incorporated convey any license under its patent or trademark rights, nor the rights of others. Any Customer or user of this document or products described herein in such applications shall assume .

all risks of such use and will agree to hold Ascendsemi Incorporated and all the companies whose products are represented on Xi'an Ascend Semiconductor Incorporated website, harmless against all damages.

Xi'an Ascend Semiconductor Incorporated does not warrant or accept any liability whatsoever in respect of any products purchased through unauthorized sales channel. Should Customers purchase or use Xi'an Ascend Semiconductor Incorporated products for any unintended or unauthorized application, Customers shall indemnify and hold Xi'an Ascend Semiconductor Incorporated and its representatives harmless against all claims, damages, expenses, and attorney fees arising out of, directly or indirectly, any claim of personal injury or death associated with such unintended or unauthorized application.

www.ascendsemi.com