

FR601 THRU FR607

List

List..... 1

Package outline..... 2

Features..... 2

Mechanical data..... 2

Maximum ratings2

Rating and characteristic curves..... 3

Pinning information.....4

Marking..... 4

Taping & bulk specifications for AXIAL devices..... 4

Suggested thermal profiles for soldering processes..... 5

High reliability test capabilities.....6

FR601 THRU FR607

6.0A Axial Leaded Fast Recovery Rectifiers - 50V-1000V

Features

- Axial lead type devices for through hole design.
- High current capability.
- Fast switching for high efficiency.
- High surge capability.
- Silicon rubber coating chip junction.
- Lead-free parts meet RoHS requirements.
- Suffix "-H" indicates Halogen-free parts, ex. FR601-H.

Mechanical data

- Epoxy : UL94-V0 rated flame retardant
- Case : Molded plastic, P600
- Lead : Axial leads, solderable per MIL-STD-202, Method 208 guaranteed
- Polarity: Color band denotes cathode end
- Mounting Position : Any
- Weight : Approximated 1.75 gram

Package outline

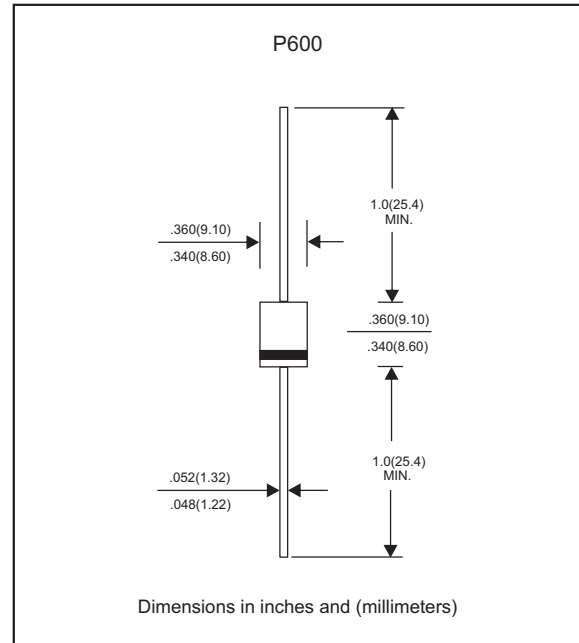

Maximum ratings and Electrical Characteristics (AT $T_A=25^{\circ}\text{C}$ unless otherwise noted)

PARAMETER	CONDITIONS	Symbol	MIN.	TYP.	MAX.	UNIT
Forward rectified current	See Fig.1	I_o			6.0	A
Forward surge current	8.3ms single half sine-wave (JEDEC methode)	I_{FSM}			300	A
Reverse current	$V_R = V_{RRM} T_J = 25^{\circ}\text{C}$	I_R			5.0	μA
	$V_R = V_{RRM} T_J = 100^{\circ}\text{C}$				150	
Diode junction capacitance	f=1MHz and applied 4V DC reverse voltage	C_J		100		pF
Storage temperature		T_{STG}	-65		+175	$^{\circ}\text{C}$

SYMBOLS	V_{RRM}^{*1} (V)	V_{RMS}^{*2} (V)	V_R^{*3} (V)	V_F^{*4} (V)	t_{rr}^{*5} (ns)	Operating temperature $T_J, (^{\circ}\text{C})$
FR601	50	35	50	1.30	150	-55 to +125
FR602	100	70	100			
FR603	200	140	200			
FR604	400	280	400		250	
FR605	600	420	600			
FR606	800	560	800			
FR607	1000	700	1000	500		

- *1 Repetitive peak reverse voltage
- *2 RMS voltage
- *3 Continuous reverse voltage
- *4 Maximum forward voltage@ $I_F=6.0\text{A}$
- *5 Maximum Reverse recovery time, note 1

Note 1. Reverse recovery time test condition, $I_F=0.5\text{A}$, $I_R=1.0\text{A}$, $I_{RR}=0.25\text{A}$

Rating and characteristic curves (FR601 THRU FR607)

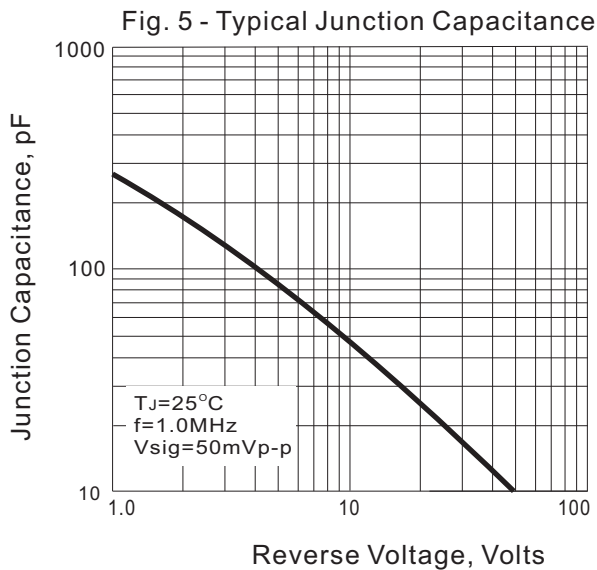
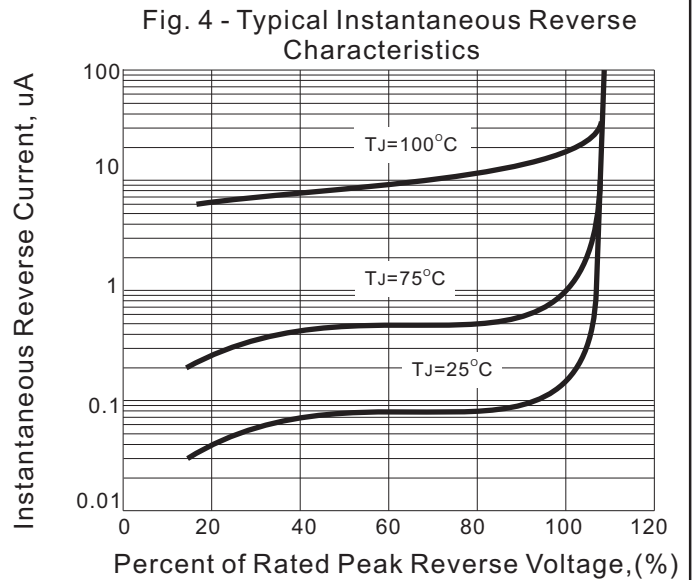
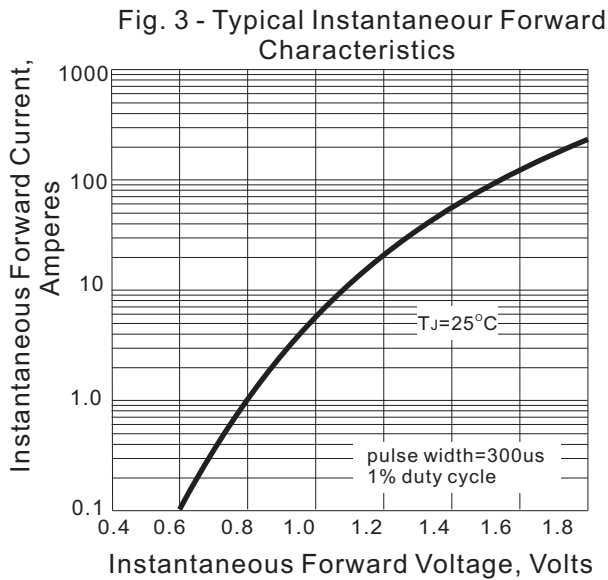
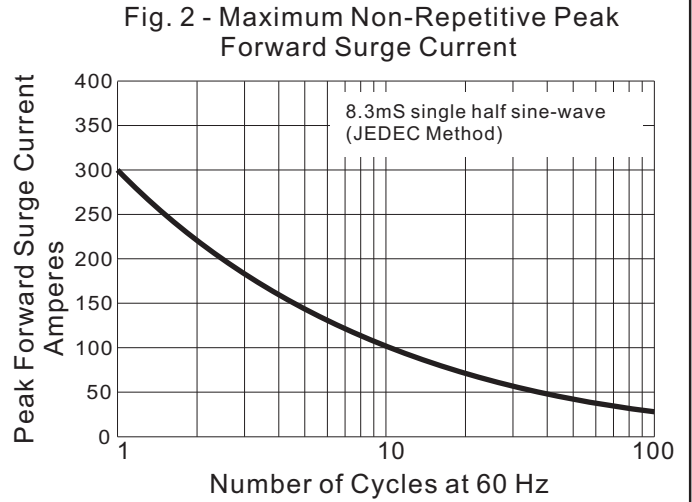
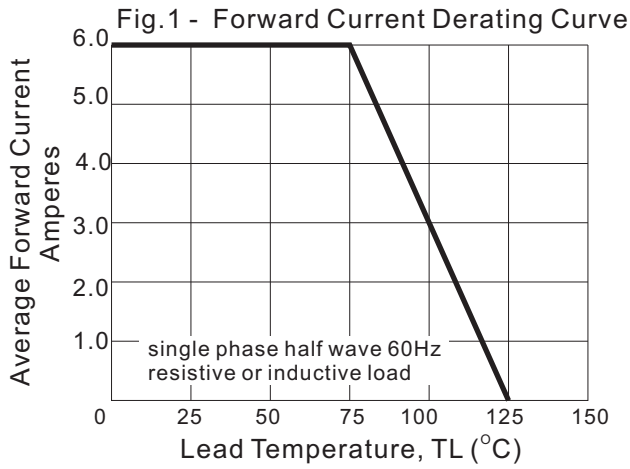
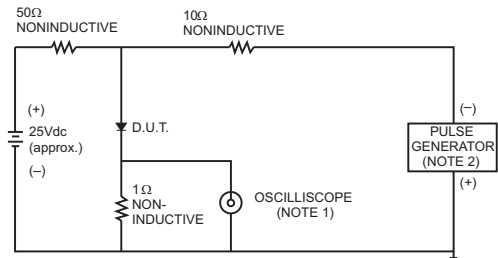
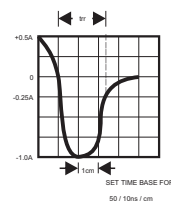

Fig. 6 - Test Circuit Diagram and Reverse Recovery Time Characteristic





- NOTES: 1. Rise Time= 7ns max., Input Impedance= 1 megohm.22pF.
2. Rise Time= 10ns max., Source Impedance= 50 ohms.



FR601 THRU FR607

Pinning information

Pin	Simplified outline	Symbol
Pin1 cathode Pin2 anode		

Marking

Type number	Marking code
FR601	FR601
FR602	FR602
FR603	FR603
FR604	FR604
FR605	FR605
FR606	FR606
FR607	FR607

Taping & bulk specifications for AXIAL devices

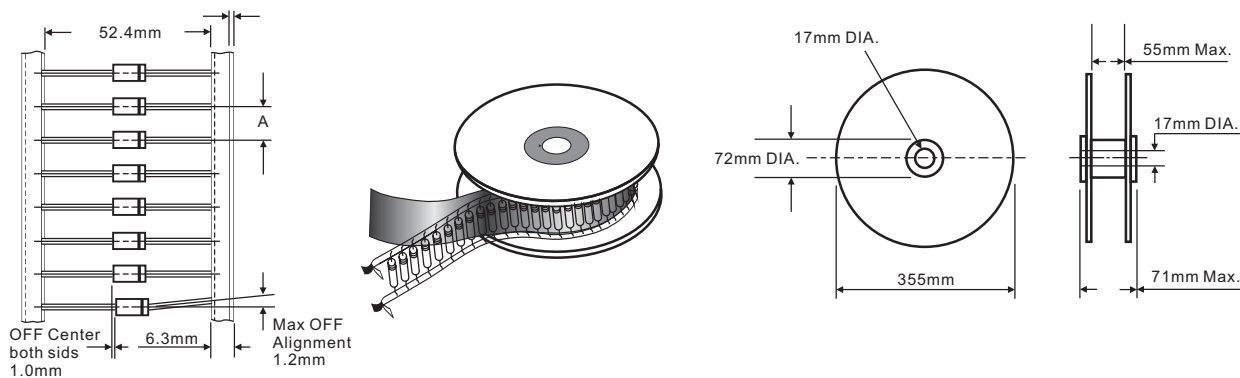

REEL PACKING

DEVICE CASE TYPE	Q'TY 1 (PCS / REEL)	COMPONENT SPACING "A" in FIG. A	CARTON SIZE (m/m)	Q'TY 2 (PCS / CARTON)	APPROX. CROSS WEIGHT(kg)
P600	1,000	5 mm	360 * 340 * 370	4,000	9.5

AMMO PACKING

DEVICE CASE TYPE	Q'TY 1 (PCS / BOX)	INNER BOX SIZE (m/m)	CARTON SIZE (m/m)	Q'TY 2 (PCS / CARTON)	APPROX. CROSS WEIGHT(kg)
P600	500	260 * 83 * 160	440 * 270 * 340	5,000	12.0

FR601 THRU FR607

BULK PACKING

DEVICE CASE TYPE	Q'TY 1 (PCS / BOX)	INNER BOX SIZE (m/m)	CARTON SIZE (m/m)	Q'TY 2 (PCS / CARTON)	APPROX. CROSS WEIGHT(kg)
P600	250	305 * 73 * 40	347 * 320 * 271	6,000	14.5

Suggested thermal profiles for soldering processes

1. Lead free temperature profile wave-soldering

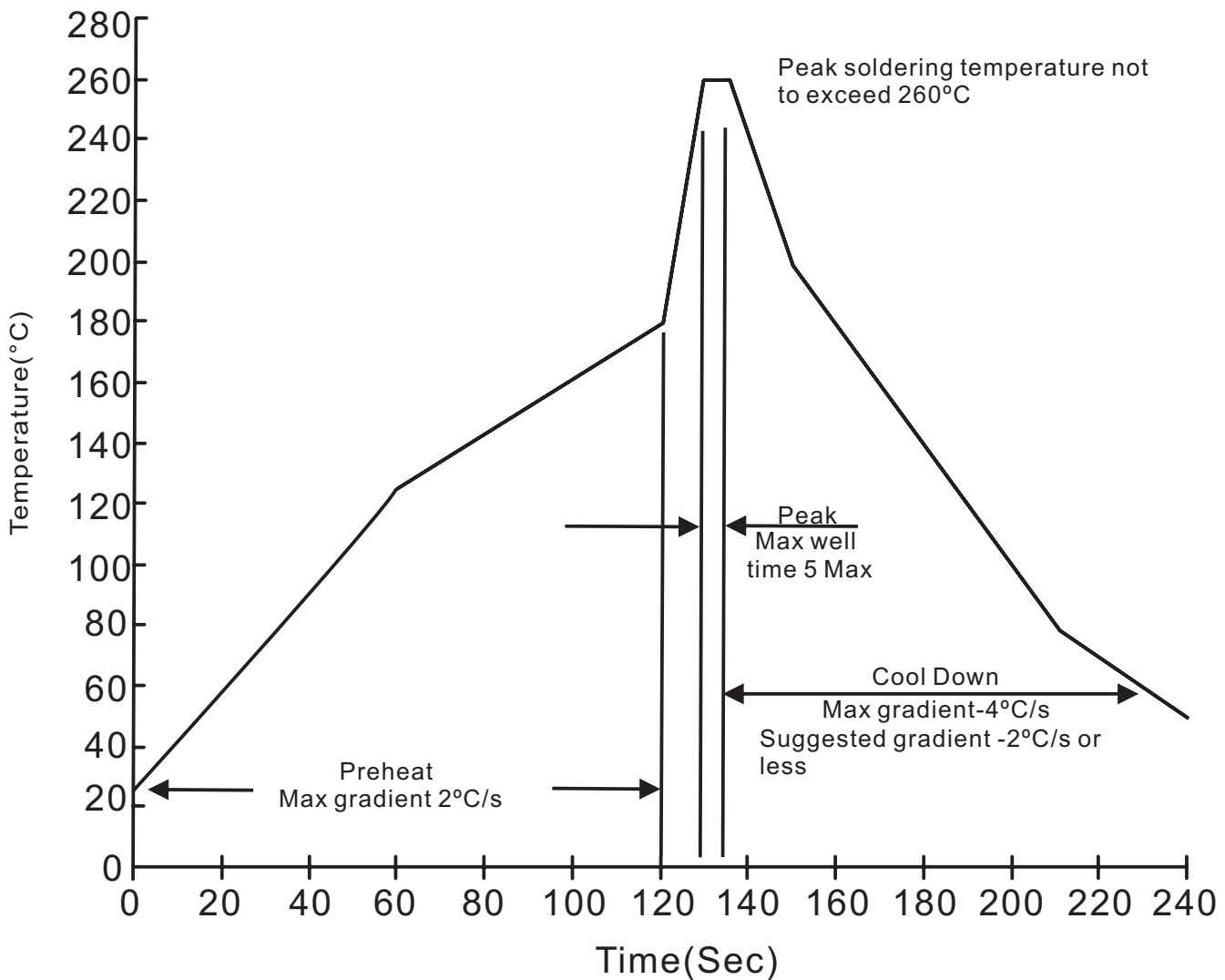

FR601 THRU FR607**High reliability test capabilities**

Item Test	Conditions	Reference
1. Solder Resistance	at 260±5°C for 10±2sec. immerse body into solder 1/16"±1/32"	MIL-STD-750D METHOD-2031
2. Solderability	at 245±5°C for 5 sec.	MIL-STD-202F METHOD-208
3. Pull Test	2.0kg in axial lead direction for 10 sec. $I_F = I_O$	MIL-STD-202F METHOD-211A
4. Bend Lead	2.0kg weight applied to each lead bending arc 90°±5° for 3 times	MIL-STD-202F METHOD-211A
5. High Temperature Reverse Bias	$V_R = 80\%$ rate at $T_J = 125^\circ\text{C}$ for 168 hrs.	MIL-STD-750D METHOD-1038
6. Forward Operation Life	Rated average rectifier current at $T_A = 25^\circ\text{C}$ for 500hrs.	MIL-STD-750D METHOD-1027
7. Intermittent Operation Life	$T_A = 25^\circ\text{C}$, $I_F = I_O$ On state: power on for 5 min. off state: power off for 5 min, on and off for 500 cycles.	MIL-STD-750D METHOD-1036
8. Pressure Cooker	15P _{sig} at $T_A = 121^\circ\text{C}$ for 4 hrs.	JESD22-A102
9. Temperature Cycling	-55°C to +125°C dwelled for 30 min. and transferred for 5min. total 10 cycles.	MIL-STD-750D METHOD-1051
10. Forward Surge	8.3ms single half sine-wave one surge.	MIL-STD-750D METHOD-4066-2
11. Humidity	at $T_A = 85^\circ\text{C}$, RH=85% for 1000hrs.	MIL-STD-750D METHOD-1021
12. High Temperature Storage Life	at 175°C for 1000 hrs.	MIL-STD-750D METHOD-1031