

| Rev No. | Description of Revision | Date | Name | Approved | ECN No. |
|---------|-------------------------|------|------|----------|---------|
| △ | | | | | |

NOTES:

- 1.MATERIAL:
MOLDING: LCP UL94 V-0
CONTACT:COPPER ALLOY.
GOLD PLATED Min ON CONTACT AREA,100u”
Min TIN (LEAD FREE) ON SOLDER AREA,
SHELL: SUS201-H,T=0.30±0.03mm
50u” NICKEL PLATING OVER ALL.
- 2.MECHANICAL:
INSERTION: 5~20N.
EXTRACTION: 8~20N AFTER TEST.
DURABILITY: 5000 CYCLES
- 3.ELECTRICAL:
CURRENT: 3A FOR VBUS;
1.25A FOR GND PIN.
0.25A FOR OTHER.

- 4.ENVIRONMENTAL
TEMPERATURE RANGE -25°C ~ +85°C
5. 尺寸标注事项:
图示有标示“△”者为首样全检,重点管控尺寸.
产品符合RoHS标准
- 6.

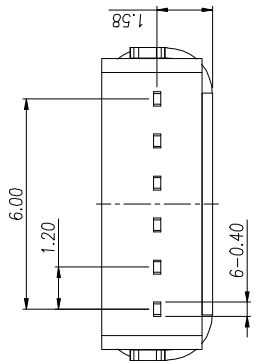
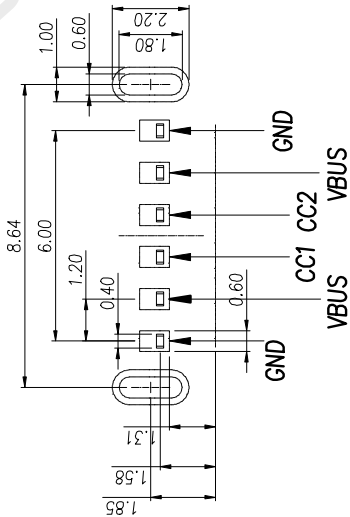
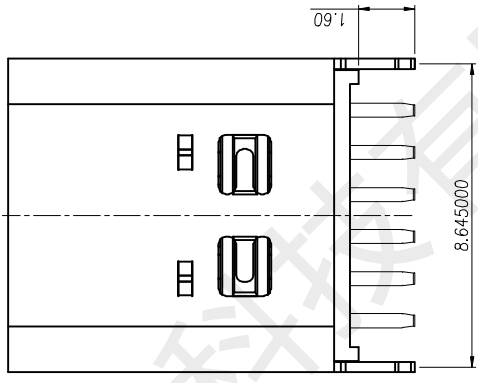
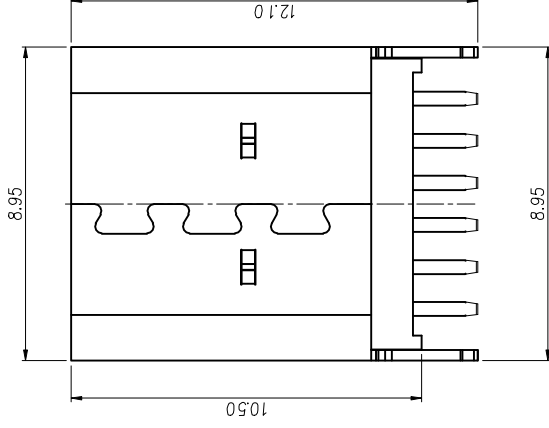
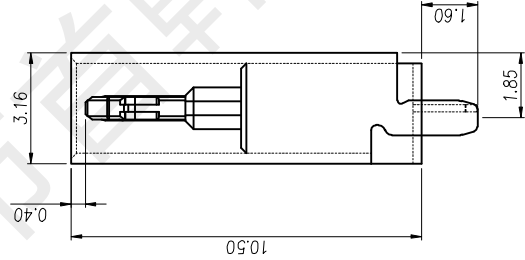
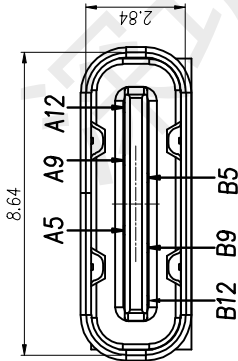

| | |
|-----|-------------|
| B12 | GND |
| B9 | VBUS |
| B5 | CC2 |
| A5 | CC1 |
| A9 | VBUS |
| A12 | GND |
| PIN | SIGNAL NAME |

| | | | |
|---------------------------------------|-------------|------------|----------------|
| UNLESS OTHERWISE SPECIFIED TOLERANCES | | TITLE | TYPE-C |
| DECIMALS: | ANGLES | Drwn | 李春风 |
| X. ±0.20 | X° ±2° | Checked | 钟兴华 |
| X-X ±0.10 | X.X° ±1° | Approved | 罗孝金 |
| X-XX ±0.05 | X.XX° ±0.5° | PART NO. : | 6P LCH10.5 073 |
| XXX ±0.03 | | SCALE: | 1:5 |
| | | UNIT: | mm |
| | | SIZE: | A4 |
| | | SHEET: | 2 OF 2 |
| | | REV. | A |

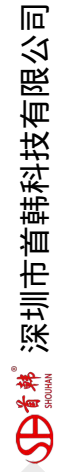

深圳市首韩科技有限公司

RECOMMENDED P.C.B. LAYOUT TOLERANCE UNSPECIFIED ±0.05mm



深圳市首韩科技有限公司

SHENZHEN SHOUHAN TECHNOLOGY CO., LTD

Tel: 0755-27597601 Fax: 0755-27597491

承 认 书
SPECIFICATION FOR APPROVAL

客 户 Customer:

产品名称 Project:

TYPE-C

规格型号 Part No:

6P LCH10.5 073

贵公司承认印 Approval signatures

| 料 号/Part No. | 签 章/Signatures |
|--------------|----------------|
| | |

日期 Date:

| | | |
|-------------|-----|--|
| 拟制/Drawn | 李春风 |  |
| 审核/Check | 钟华华 | |
| 批准/Approved | 罗孝金 | |

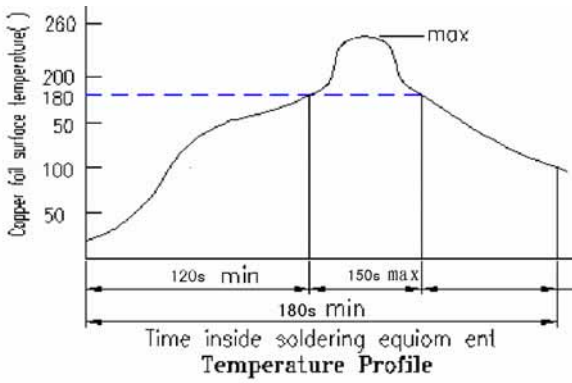

| | | | |
|--|-------------------------------|--|--|
| RATING (额定值) | | 20V3A | |
| PRACTICAL TEMPERATURE RANGE 使用温度范围 | | -25~85°C 在-25°C~+85°C 温度内使用 | |
| STANDARD ATMOSPHEIC CONDITIONS 测试标准状况 | | UNLESS OTHERWISE SPECIFIED THE STANDARD RANGE OF ATMOSPHERIC CONDITIONS FOR MAKING MEASUREMENTS AND TESTS ARE AS FOLLOWS: (1) BETWEEN BODY AND CONDUCTOR: 5°C TO 35°C (2) BETWEEN CONDUCTORS NOT TO BE CONTACT: 45% TO 85% (3) PRESSURE: 86Kpa TO 106Kpa 在没有指定的情况下测试温度、湿度、气压如下: (1) 温度为 5°C~35°C (2) 湿度为 45%~85% (3) 气压为 86 Kpa~106Kpa | |
| MECHANICAL (机械性能) | | | |
| ITEM 项目 | | TEST CONDITIONS 测试条件 | |
| 1 | CONNECTION FORCE 插入力度 | MEASUREMENT SHALL BE MADE AFTER CONNECTING AND DISCONNECTING USING STANDARD PLUG GAUGE 3 TIMES. 依据标准的 PLUG GAUGE 做第 3 次拔插后测定 | 5-20N |
| | DISCONNECTI ON FORCE 拔出力度 | MEASUREMENT SHALL BE MADE AFTER CONNECTING AND DISCONNECTING USING STANDARD PLUG GAUGE 3 TIMES. 依据标准的 PLUG GAUGE 做第 3 次拔插后测定 | 8-20N |
| 2 | TERMINAL STRENGTH 端子强度 | A STATIC LOAD OF 0.1N/m(1kgf/cm)SHALL BE APPLIED TO THE TIP OF THE TERMINAL FOR 1 MIN IN ANY DIRECTION 向排脚先端的任意一个方向加 1 分钟 0.1N/m(1kgf/cm)的力度. | THERE SHALL BE NO DAMAGE TO THE TERMINAL SUCH AS CRACKS, LOOSENESS OR PLAY ELECTRICAL ,AND MECHANICAL CHARACTERISTICS SHALL BE SATISFIED 在排脚中没有裂开、松动等异常, 满足于机械、电气性能 |
| ELECTRICAL (电气性能) | | | |
| ITEM 项目 | | TEST CONDITIONS 测试条件 | |
| 3.1 | CONTACT RESISTANCE 接触电阻 | MEASURED AT SMALL CURRENT (100mA OR LESS) 1000Hz 在微小电流 (100 mA) 以下测试 | 40mΩ MAX |
| 3.2 | INSULATION RESISTANCE 绝缘电阻 | APPLY A VOLTAGE OF 100V DC FOR 1 MIN TO FOLLOWING PORTIONS AFTER WHICH MEASUREMENT SHALL BE MADE: (1) BETWEEN BODY AND CONDUCTOR (2) BETWEEN CONDUCTORS NOT TO BE CONTACT (3) BETWEEN CONDUCTORS NOT TO BE WHEN PLUG IS INSERTED DC100V 1 MIN 输入 100V DC 电压 1 分钟, 按以下接触方法测试: (1) 插座体与排脚之间 (2) 不接触的排脚之间 (3) 插头插入时不接触排脚之间 | 100MΩ MIN |

| | | | |
|------------------------|---|--|--|
| 3.3 | <p>DIELECTRIC STRENGTH 耐电压</p> | <p>AC 100V 5ms(50~60Hz)FOR 1 MIN TRIP CURRENT:0.5mA (1) BETWEEN BODY AND CONDUCTOR (2) BETWEEN CONDUCTORS NOT TO BE CONTACT (3) BETWEEN CONDUCTORS NOT TO BE WHEN PLUG IS INSERTED DC 100V 1 MIN 输入 AC 100V (50Hz) /min 电压 1 分钟感度电流为 0.5mA, 按以下接触方法测试: (1) 插座体与排脚之间 (2) 不接触的排脚之间 (3) 插头插入时不接触排脚之间</p> | <p>WITHOUT DAMAGE TO PARTS ARCING OR BREAKDOWN ETC 没有绝缘破坏等异常</p> |
| URABILITY (耐久性) | | | |
| ITEM 项目 | | TEST CONDITIONS 测试条件 | PERFORMANCE 规格 |
| 4. 1 | <p>SOLDERABILITY TEST 可焊性试验</p> | <p>THE TOP OF THE TERMINALS SHALL BE DIPPED 1mm IN THE SOLDER BATH OF 250±5°C FOR 5±0.5 SECONDS 端子顶部被浸入锡池中 1mm 深,温度为 250±5°C,时间为 5±0.5 秒</p> | <p>(1) SOLDER WETTING TIME SHALL BE 3 SEC OR LESS 焊接时间应少于 3 秒 (2) THE AREA OF SOLDERING SHOULD BE OVER 75% 焊接面积应有 75%以上</p> |
| 4.2 | <p>RESISTANCE TO SOLDERING HEAT TEST 耐焊性试验</p> | <p>REFLOW SOLDERING CONDITIONS: PREHEAT:TEMPERATURE ON THE COPPER FOIL SURFACE SHOULD REACH 180 .120S AFTER THE P.C.B ENTERED INTO THE SOLDERING EQUIPMENT. TALLEST TEMPERATURE:TEMPERATURE ON THE COPPER FOIL SURFACE SHOULD REACH THE PEAK TEMPERATURE OF 260±5 WITH IN 20 SECONDS. 过回流焊条件: 预热:电镀层表面的温度应达到 180°C,120s 后电路板进入回流焊设备。 最高温度:电镀层表面温度最高为 260±5°C且停留不超过 20 秒。</p>  <p style="text-align: center;">Temperature Profile</p> | <p>WITHOUT DEFOR MATION OF CASE OR EXCESSIVE LOOSENESS OF TEMINALS ELECTRICAL CHARACTERISTICS SHALL BE SATISFIED 本体无变形, 满足于机械、电气性能</p> |

| | | | |
|------|--|---|--|
| 4. 2 | RESISTANCE TO SOLDERING HEAT TEST 耐焊性试验 | <p>SOLDERING IRON METHOD: BIT TEMPERATURE $330 \pm 5^{\circ}\text{C}$ APPLICATION TIME OF SOLDERING IRON $3 \pm 0.5 \text{ SEC}$ HOWEVER EXCESSIVE PRESSURE SHALL NOT BE APPLIED TO THE TERMINAL 手焊接的时候温度需控制在 $330 \pm 5^{\circ}\text{C}$, 时间为 3 ± 0.5 秒, 但不能在排脚上施加异常压力。</p> | <p>WITHOUT DEFORMATION OF CASE OR EXCESSIVE LOOSENESS OF TEMINALS ELECTRICAL CHARACTERISTICS SHALL BE SATISFIED 本体无变形, 满足于机械、电气性能</p> |
| 4. 3 | HUMIDITY TEST 潮湿试验 | <p>THE JACK SHALL BE STORED AT A TEMPERATURE OF $40 \pm 2^{\circ}\text{C}$ AND A HUMIDITY OF 90% TO 96% FOR 96 Hr, THEN THE JACK SHALL BE MAINTAINED AT STANDARD ATMOSPHERIC CONDITION FOR 1 Hr FOR OTHER PROCEDURES 放置 $40 \pm 2^{\circ}\text{C}$ 的相应湿度为 90~96% Hr 环境中 96 小时后, 再将样板放在正常环境中 1 小时后进行测试</p> | <p>THERE SHALL BE NO DAMAGE ON APPEARANCE. MECHANICAL AND ELECTRICAL CHARACTERISTICS SHALL BE SATISFIED 外观无异常, 满足于机械、电气性能。</p> |
| 4.4 | HEAT TEST 耐热试验 | <p>THE JACK SHALL BE STORED AT A TEMPERATURE OF $70 \pm 2^{\circ}\text{C}$ FOR 96 HOURS, AND THEN IT SHALL BE SUBJECTED TO THE CONTROLLED RECOVERY MBASURBM 放置在温度 $70 \pm 2^{\circ}\text{C}$ 中测试 96 小时后, 再放置正常室温中 1 小时来测定</p> | |
| 4. 5 | COLD TEST 耐寒试验 | <p>THE JACK SHALL BE STORED AT A TEMPERATURE OF $-25 \pm 3^{\circ}\text{C}$ FOR 96 HOURS AND THEN IT SHALL BE SUBJECTED TO THE CONTROLLED RECOVERY CONDITIONS FOR 1 HOUR AFTER WHICH 放置在温度 $-25 \pm 3^{\circ}\text{C}$ 中 96 小时后, 再放置常温常湿中 1 小时来测定</p> | <p>THERE SHALL BE NO DAMAGE ON APPEARANCE MECHANICAL AND ELECTRICAL CHARACTERISTICS SHALL BE SATISFIED 外观无异常, 满足于机械、电气性能</p> |
| 4. 6 | LIFE TEST 寿命试验 | <p>WITHOUT LOAD CONNECTION AND DISCONNECTION SHALL BE MADE WITH THE MATING PLUGS AND JACKS FOR 5000 CYCLES AT A SPEED OF 10 TO 25 CYCLES/MIN 无负荷 将结合了的的标准 Plug (尽量要近于中心的) 在 1 分钟内以 10-25 的速度, 进行 5000 次插入, 拔出 LOAD: AT RATING CONDITION (NON-INDUCTIVE LOAD) CONNECTION AND DISCONNECTION SHALL BE MADE 5000 CYCLES AT A SPEED 10 TO 20 CYCLES / MIN 负荷 以定格状态(无诱导负荷)在 1 分钟内以 10-20 次的速度进行 5000 次插入、拔出</p> | <p>(1) CONTACT RESISTANCE SHALL BE $\leq 0.1 \Omega$ (2) DISCONNECTION FORCE SHALL BE 0.8 TO 2.0N (3) MECHANICAL AND ELECTRICAL CHARACTERISTICS SHALL BE SATISFIED (1) 接触电阻 $\leq 0.1 \Omega$ (2) 拔出力是 0.8~2.0N (3) 其它: 满足于机械、电气性能</p> |

| | | | |
|------------|--|---|---|
| <p>4.7</p> | <p>TEMPERATURE CYCLING TEST 温度循环测试</p> | <p>THE JACK SHALL BE SUB JECTED TO 5 CYCLES OF THE FOLLOWING CONDITIONS SHOWN IN THE FIGURE,AND THEN SHALL RETURNED ALLOWED TO REMAIN IN ROOM AMBIENT CONDITION FOR 30 MINUTES 将插座以下列条件作 5 个循环，然后放回室内环境 30 分钟</p> <p>Temp(°C)</p>  | <p>THERE SHALL BE NO DEFORMATION OR CRACKS IN MOLDED PART. INSERTION & EXTRACTION FORCE:3 TO 20N CONTACT RESISTANCE:MAX.30M Ω INSULATION RESISTANCE: MIN.100 M Ω DIELECTRIC WITHSTANDING VOLTAGE: 100VAC/MIN(BETWEEN TERMINALS)</p> <p>产品不能变形与破裂 插拔力: 3N 至 20N 接触电阻: 最大 30m Ω 绝缘电阻: 最小 100 M Ω 绝缘耐压: 最小 100VAC (端子之间)</p> |
| <p>4.8</p> | <p>COLD&HEAT SHOCK TEST 冷热冲击测试</p> | <p>THE JACK SHALL BE SUBJECTED TO 5 CYCLES OF THE FOLLOWING CONDITIONS SHOWN IN THE FIGURE,AND THEN SHALL RETURNED AND ALLOWED TO REMAIN IN ROOM AMBIENT CONDITION FOR 30 MINUTES 将插座以下列条件作 5 个循环，然后放回室内环境 30 分钟</p> <p>TEMP (°C)</p>  | <p>THERE SHALL BE NO DEFORMATION OR CRACKS IN MOLDED PART. INSERTION & EXTRACTION FORCE:3 TO 25N CONTACT RESISTANCE:MAX.30M Ω INSULATION RESISTANCE: MIN.100 M Ω DIELECTRIC WITHSTANDING VOLTAGE: 500VAC/MIN(BETWEEN TERMINALS)</p> <p>产品不能变形与破裂 插拔力: 3N 至 25N 接触电阻: 最大 30m Ω 绝缘电阻: 最小 100 M Ω 绝缘耐压: 最小 500VAC (端子之间)</p> |