

客户料号:

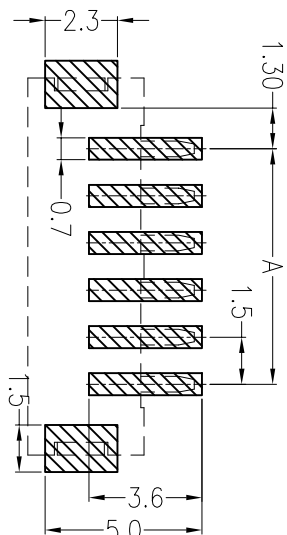

SUGGESTED PCB LAYOUT

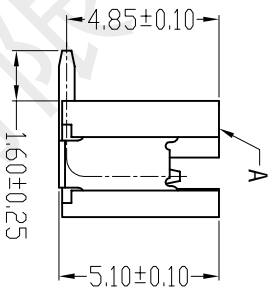
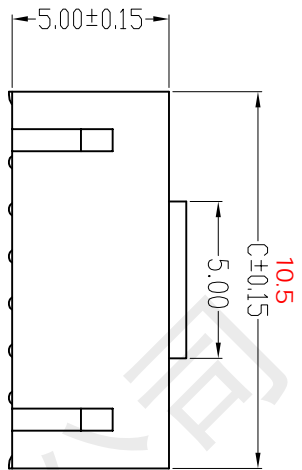
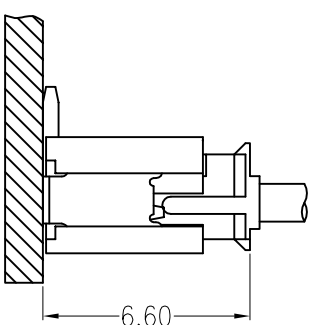

Assembly Layout

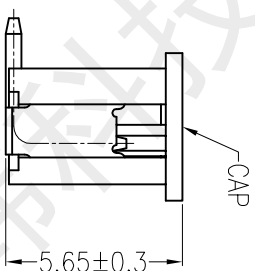
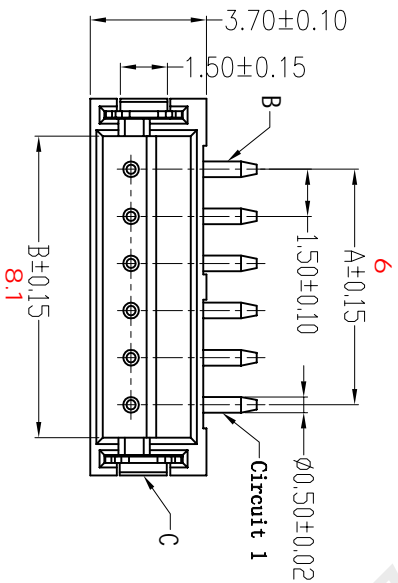

Circuits	Dimensions (mm)			Circuits	Dimensions (mm)		
	A	B	C		A	B	C
02	1.50	3.60	6.00	10	13.50	15.60	18.00
03	3.00	5.10	7.50	11	15.00	17.10	19.50
04	4.50	6.60	9.00	12	16.50	18.60	21.00
05	6.00	8.10	10.50	13	18.00	20.10	22.50
06	7.50	9.60	12.00	14	19.50	21.60	24.00
07	9.00	11.10	13.50	15	21.00	23.10	25.50
08	10.50	12.60	15.00	16	22.50	24.60	27.00
09	12.00	14.10	16.50				

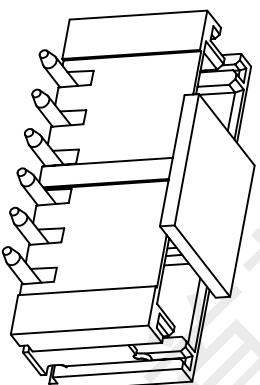

### 主要技术参数 Main Specifications

线数 (Poles): 02 to 16  
 接触电阻 (Contact resistance):  $\leq 20m\Omega$   
 绝缘电阻 (Insulation resistance):  $\geq 500M\Omega$   
 额定电压 (Rated voltage): 125V AC DC  
 额定电流 (Rated current): 1.0A AC DC  
 耐电压 (Withstand Voltage): 500V AC/minute  
 温度范围 (Temperature Range):  $-25^{\circ}C \sim +105^{\circ}C$

#### ORDER INFORMATION:

**A1501AWY-\*\*-F2MA-G-X**

PART No. \_\_\_\_\_  
 No. OF CIRCUITS: \_\_\_\_\_  
 PLASTIC MATERIAL: \_\_\_\_\_  
 P2M=LCP (BEIGE)  
 SPECIAL CODE:  
 X=CAP  
 G=TUBY  
 R=REEL  
 P=PE  
 PLATING:  
 A=Sn

APPROVED BY		UNIT		TOLERANCE		L.T.P.		REVISION RECORD		NAME		DATE	
罗孝金		MM		X.X ±0.30		①							
CHECKED BY		SCALE		X.XX ±0.20		②							
钟华华		FULL		X.XXX ±0.10		③							
DRAWN BY		DATE		REVISION		ANGLE							
李春风		2014.03.06		A/0		X° ±3.0°		⑤					

MODEL NO:

MODEL NAME: 1.5-5P LT

首韩 SHOUHAN 深圳市首韩科技有限公司



深圳市首韩科技有限公司

SHENZHEN SHOUHAN TECHNOLOGY CO., LTD

Tel: 0755-27597601 Fax: 0755-27597491

# 承 认 书

## SPECIFICATION FOR APPROVAL

客 户 Customer:

\_\_\_\_\_

产品名称 Project:

针座

\_\_\_\_\_

规格型号 Part No:

1.5-5P LT

\_\_\_\_\_

### 贵公司承认印 Approval signatures

料 号/Part No.	签 章/Signatures

日期 Date:

拟制/Drawn	李春风	
审核/Check	钟华华	
批准/Approved	罗孝金	

## 1、SCOPE: (适用范围)

1.1 This specification covers production and inspection of Connector.

本规范内容适用于本公司普通系列型条形连接器（针座）产品的生产与检验。

## 2、USE CONDITION: (使用条件)

### 2.1 Ambient temperature Range:-25℃~+105℃

环境温度：-25℃~+105℃

### 2.2 Applicable Wire Sizes:AWG#28~#32

适用线规：AWG#28~#32

### 2.3 Applicable PC board thickness:0.6~1.2mm

适用PC板厚度：0.6~1.2mm

## 3、Appearance and Dimension: (外观及尺寸)

### 3.1 Appearance:Product surface without defect、dirt、crack、and mechanical damang, Contact without rust,plating not oxidized and not peeled.

产品表面不应有对制品有害的缺陷、污垢、裂痕及机械损伤；接触件无锈蚀、镀层氧化、脱落等现象。

### 3.2 Dimension:According to drawings

外形尺寸：依照附图

### 3.3 Exchangable:Exchangable with same specification products.

互换性：相同规格应能互换

## 4、Material:

### 材 料

P/N 零件名称	Type 类 型	Material 材 料	Finish 表面处理	Explain 说 明
Terminal 端子	Contact 插 簧	Phosphor bronze 锡青磷铜 厚 0.15mm	Tin Plating:3~4 μ m 镀锡：3~4 μ m	RoHS Compliant
Housing 孔 座	Plastic 塑 壳	Nylon66 UL94V-0	Color:White 颜色：白色	
Opening Wafer 开口针座	Contact 插 针	Phosphor bronze 锡青磷铜 厚 0.30mm	Tin Plating:3~4 μ m 镀锡：3~4 μ m	
	Plastic 塑 壳	Nylon46 UL94V-0	Color: Beige 颜色：米色	
Lips Wafer 闭口针座	Contact 插 针	Phosphor bronze 锡青磷铜 厚 0.30mm	Gold Plating:3~4 μ " m 镀金：3~4 μ " m	
	Plastic 塑 壳	PBT UL94V-0	Color: White 颜色：白色	
Tiepian Wafer 卧贴针座 立贴针座	Contact 插 针	Phosphor bronze 锡青磷铜 厚 0.30mm	Tin Plating:3~4 μ m 镀锡：3~4 μ m	
	Solder tabs 焊护耳	Phosphor bronze 锡青磷铜 厚 0.25mm	Tin Plating:3~4 μ m 镀锡：3~4 μ m	
	Plastic 塑 壳	Nylon46 UL94V-0	Color: Beige 颜色：米色	

## 5、Electrical Performance:

电气性能

N0. 序号	Ltem 项目	Requirement 技术要求
5.1	Voltage Rated 额定电压	125V AC DC
5.2	Current Rated 额定电流	1A AC DC
5.3	Contact Resistance 接触电阻	$\leq 20 \text{ m}\Omega$
5.4	Insulation Resistance 绝缘电阻	$\geq 500 \text{ M}\Omega$
5.5	Dielectric Strength 耐压	$\geq 500\text{V AC/minute}$

## 6、Mechanical Performance:

机械性能

N0. 序号	Ltem 项目	Requirement 技术要求
6.1	Male contact Retention force PIN 针固定力	$\geq 15\text{N}$ per pin
6.2	Female contact Retention force 端子固定力	$\geq 15\text{N}$ per pin
6.3	Plug-in force 插入力	$\leq 3\text{N}$ per pin
6.4	Plug-out force 拔出力	$\geq 0.5\text{N}$ per pin

## 7、Endurance Characteristics:

环境性能

N0. 序号	Ltem 项目	Requirement 技术要求
7.1	Soldering rest 可焊性	Time: $2.5 \pm 0.5\text{S}$ 时间: $2.5 \pm 0.5\text{S}$  Temperature: $260 \pm 5^\circ\text{C}$ 温度: $260 \pm 5^\circ\text{C}$  Area of Soldering: $\geq 95\%$ 焊锡面积: $\geq 95\%$

7.2	Resistance to soldering Heat 耐焊接热	Time: $5 \pm 1S$ 时间: $5 \pm 1S$  Temperature: $260 \pm 5^{\circ}C$ 温度: $260 \pm 5^{\circ}C$  Appearance: NO Damage 外观: 无损坏
7.3	Heat test 耐热性	Time: 96h 时间: 96 小时  Temperature: $+85 \pm 3^{\circ}C$ 温度: $+85 \pm 3^{\circ}C$  Appearance: NO Damage 外观: 无损坏  Contact resistance: $\leq 20 m\Omega$ 接触电阻: $\leq 20 m\Omega$
7.4	Cold test 耐冷性	Time: 48h 时间: 48 小时  Temperature: $-25 \pm 3^{\circ}C$ 温度: $-25 \pm 3^{\circ}C$  Appearance: NO Damage 外观: 无损坏  Contact resistance: $\leq 20 m\Omega$ 接触电阻: $\leq 20 m\Omega$
7.5	Temperature Cycling 温度循环	Low temperature: $-25 \pm 3^{\circ}C$ 低温: $-25 \pm 3^{\circ}C$  High temperature: $85 \pm 3^{\circ}C$ 高温: $85 \pm 3^{\circ}C$  For 5 cycles. test after keeping in Normal Condition for 30 min.  5 次循环后, 放置在正常环境中 30 分钟, 在进行测试  Appearance: NO Damage 外观: 无损坏  Contact resistance: $\leq 20 m\Omega$ 接触电阻: $\leq 20 m\Omega$

7.6	Invariab lenes humidity 恒定湿热	<p>Temperature: <math>60 \pm 2^{\circ}\text{C}</math> 温度: <math>60 \pm 2^{\circ}\text{C}</math></p> <p>Relative humidity: 90%-96% RH 相对湿度: 90%-96% RH</p> <p>Tim: 96h 时间: 96 小时</p> <p>Appearance: NO Damage 外观: 无损坏</p> <p>Contact resistance: <math>\leq 20 \text{ m}\Omega</math> 接触电阻: <math>\leq 20 \text{ m}\Omega</math></p> <p>Insulation Resistance: <math>\geq 100 \text{ M}\Omega</math> 绝缘电阻: <math>\geq 100 \text{ M}\Omega</math></p>
7.7	Salt Spray 盐雾试验	<p>Salt concentration: <math>5 \pm 1\%</math> 浓度: <math>5 \pm 1\%</math></p> <p>Temperature: <math>35 \pm 2^{\circ}\text{C}</math> 温度: <math>35 \pm 2^{\circ}\text{C}</math></p> <p>Tim: <math>16 \pm 2\text{h}</math> 时间: <math>16 \pm 2</math> 小时</p> <p>After salt is removed by running wafer and A drop is removed ,it is measured.</p> <p>把试验样品从试验箱顶悬挂下来,采用浓度 (<math>5 \pm 1</math>) %的氯化钠溶液,连续雾化 16 小时,试验后用流动的蒸馏水轻轻洗去表面沉积物,在常温常驻湿条件下恢复 1-2 小时,外观无损伤</p> <p>Appearance: NO Damage 外观: 无损坏</p> <p>Contact resistance: <math>\leq 20 \text{ m}\Omega</math> 接触电阻: <math>\leq 20 \text{ m}\Omega</math></p>

## 8、Packaging Transportation Storage

包装、运输、贮存

### 8.1 Packaging

包装

- (1) **The packing of plastic inner is the plastic bag,the packing of inner terminal is panel mounting attach material packing, marked with product name, specification model, quantity, date in produced.**

塑件内包装为塑料袋，端子内包装为盘装带料包装，装（贴）入合格证，注明产品名称、规格型号、数量生产日期

- (2) **Exterior package is carton, facing the packing list, the packing list marked with product name, specification model, quantity, date of dispatch.**

外包装为纸箱，贴装箱单、装箱单上注明产品名称、规格型号、数量、出货日期

- (3) **The product in the box must not rock.**

产品在箱内不晃动

### 8.2 Transportation

运输

**Allow for any way transportation, can't get wet and mechanical in jury.**

允许用任何方式运输，勿淋湿及机械性损伤

### 8.3 Storage

贮存

**The connector of packing finished should be in the ambient temperature between-10℃ to+40℃, Relative humidity≤80%. To store in storehouse does not have acidic, alkaline air and other corrosive gas in the ambient air.**

包装完毕的连接器应在环境温度为-10℃~+40℃，相对湿度≤80%，周围空气中没有酸性，碱性及其它腐蚀性气体的库房中贮存