

N-channel Enhanced mode TO-220 MOSFET

Features

- High ruggedness
- Low $R_{DS(ON)}$ (Typ 16.4m Ω)@ $V_{GS}=4.5V$
Low $R_{DS(ON)}$ (Typ 14.6m Ω)@ $V_{GS}=10V$
- Low Gate Charge (Typ 64nC)
- Improved dv/dt Capability
- 100% Avalanche Tested
- Application: Synchronous Rectification, Li Battery Protect Board, Inverter

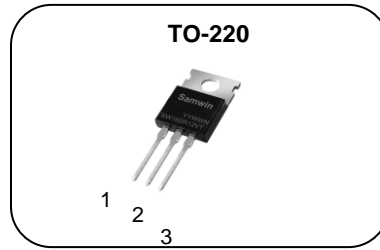

1. Gate 2. Drain 3. Source

BV_{DSS} : 120V
 I_D : 50A
 $R_{DS(ON)}$: 16.4m Ω @ $V_{GS}=4.5V$
 14.6m Ω @ $V_{GS}=10V$

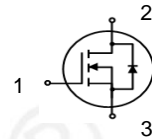

General Description

This power MOSFET is produced with advanced technology of SAMWIN. This technology enable the power MOSFET to have better characteristics, including fast switching time, low on resistance, low gate charge and especially excellent avalanche characteristics.



Order Codes

| Item | Sales Type | Marking | Package | Packaging |
|------|---------------|------------|---------|-----------|
| 1 | SW P 160R12VT | SW160R12VT | TO-220 | TUBE |

Absolute maximum ratings

| Symbol | Parameter | Value | Unit |
|----------------|------------------------------------------------------------------------------|-------------|----------------|
| V_{DSS} | Drain to source voltage | 120 | V |
| I_D | Continuous drain current (@ $T_C=25^{\circ}C$) | 50* | A |
| | Continuous drain current (@ $T_C=100^{\circ}C$) | 32* | A |
| I_{DM} | Drain current pulsed (note 1) | 200 | A |
| V_{GS} | Gate to source voltage | ± 20 | V |
| E_{AS} | Single pulsed avalanche energy (note 2) | 207 | mJ |
| E_{AR} | Repetitive avalanche energy (note 1) | 22 | mJ |
| dv/dt | Peak diode recovery dv/dt (note 3) | 5 | V/ns |
| P_D | Total power dissipation (@ $T_C=25^{\circ}C$) | 176 | W |
| | Derating factor above 25 $^{\circ}C$ | 1.4 | W/ $^{\circ}C$ |
| T_{STG}, T_J | Operating junction temperature & storage temperature | -55 ~ + 150 | $^{\circ}C$ |
| T_L | Maximum lead temperature for soldering purpose, 1/8 from case for 5 seconds. | 300 | $^{\circ}C$ |

*. Drain current is limited by junction temperature.

Thermal characteristics

| Symbol | Parameter | Value | Unit |
|------------|-----------------------------------------|-------|---------------|
| R_{thjc} | Thermal resistance, Junction to case | 0.71 | $^{\circ}C/W$ |
| R_{thja} | Thermal resistance, Junction to ambient | 52 | $^{\circ}C/W$ |

Electrical characteristic ($T_C = 25^\circ\text{C}$ unless otherwise specified)

| Symbol | Parameter | Test conditions | Min. | Typ. | Max. | Unit |
|--------------------------------|-------------------------------------------|-----------------------------------------------------------------|---------------------------|------|------|--------------------|
| Off characteristics | | | | | | |
| BV_{DSS} | Drain to source breakdown voltage | $V_{GS}=0V, I_D=250\mu A$ | 120 | | | V |
| $\Delta BV_{DSS} / \Delta T_J$ | Breakdown voltage temperature coefficient | $I_D=250\mu A$, referenced to 25°C | | 0.15 | | $V/^\circ\text{C}$ |
| I_{DSS} | Drain to source leakage current | $V_{DS}=120V, V_{GS}=0V$ | | | 1 | μA |
| | | $V_{DS}=96V, T_C=125^\circ\text{C}$ | | | 50 | μA |
| I_{GSS} | Gate to source leakage current, forward | $V_{GS}=20V, V_{DS}=0V$ | | | 100 | nA |
| | Gate to source leakage current, reverse | $V_{GS}=-20V, V_{DS}=0V$ | | | -100 | nA |
| On characteristics | | | | | | |
| $V_{GS(TH)}$ | Gate threshold voltage | $V_{DS}=V_{GS}, I_D=250\mu A$ | 1.3 | | 2.3 | V |
| $R_{DS(ON)}$ | Drain to source on state resistance | $V_{GS}=4.5V, I_D=25A$ | | 16.4 | 21 | $m\Omega$ |
| | | $V_{GS}=10V, I_D=25A$ | | 14.6 | 18 | $m\Omega$ |
| | | $V_{GS}=10V, I_D=50A$ | | 14.9 | 19 | $m\Omega$ |
| G_{fs} | Forward transconductance | $V_{DS}=5V, I_D=25A$ | | 79 | | S |
| Dynamic characteristics | | | | | | |
| C_{iss} | Input capacitance | $V_{GS}=0V, V_{DS}=60V, f=1\text{MHz}$ | | 2840 | | pF |
| C_{oss} | Output capacitance | | | 211 | | |
| C_{rss} | Reverse transfer capacitance | | | 136 | | |
| $t_{d(on)}$ | Turn on delay time | $V_{DS}=60V, I_D=30A, R_G=25\Omega, V_{GS}=10V$ (note 4,5) | | 18 | | ns |
| t_r | Rising time | | | 65 | | |
| $t_{d(off)}$ | Turn off delay time | | | 178 | | |
| t_f | Fall time | | | 130 | | |
| Q_g | Total gate charge | $V_{DS}=96V, V_{GS}=10V, I_D=30A, I_g=4\text{mA}$ (note 4,5) | | 64 | | nC |
| Q_{gs} | Gate-source charge | | | 9 | | |
| Q_{gd} | Gate-drain charge | | | 24 | | |
| R_g | Gate resistance | | $V_{DS}=0V$, Scan F mode | | 1.1 | |

Source to drain diode ratings characteristics

| Symbol | Parameter | Test conditions | Min. | Typ. | Max. | Unit |
|----------|-----------------------------|---------------------------------------------------|------|------|------|------|
| I_S | Continuous source current | Integral reverse p-n Junction diode in the MOSFET | | | 50 | A |
| I_{SM} | Pulsed source current | | | | 200 | A |
| V_{SD} | Diode forward voltage drop. | $I_S=50A, V_{GS}=0V$ | | | 1.4 | V |
| t_{rr} | Reverse recovery time | $I_S=30A, V_{GS}=0V, di_f/dt=100A/\mu s$ | | 52 | | ns |
| Q_{rr} | Reverse recovery charge | | | | 79 | nC |

※. Notes

1. Repeitative rating : pulse width limited by junction temperature.
2. $L=0.46\text{mH}, I_{AS}=30A, V_{DD}=50V, R_G=25\Omega$, Starting $T_J = 25^\circ\text{C}$
3. $I_{SD} \leq 30A, di/dt = 100A/\mu s, V_{DD} \leq BV_{DSS}$, Starting $T_J = 25^\circ\text{C}$
4. Pulse Test : Pulse Width $\leq 300\mu s$, duty cycle $\leq 2\%$.
5. Essentially independent of operating temperature.

Fig. 1. On-state characteristics

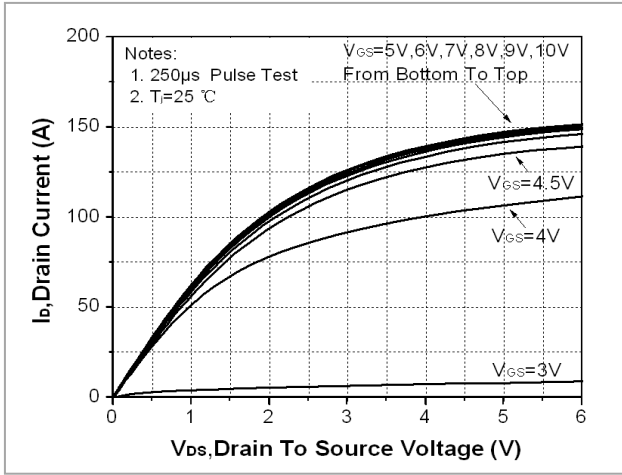

Fig. 2. Transfer characteristics

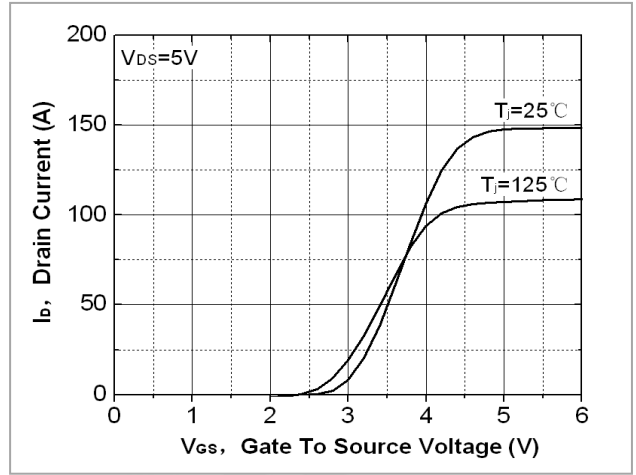

Fig. 3. On-resistance variation vs. drain current and gate voltage

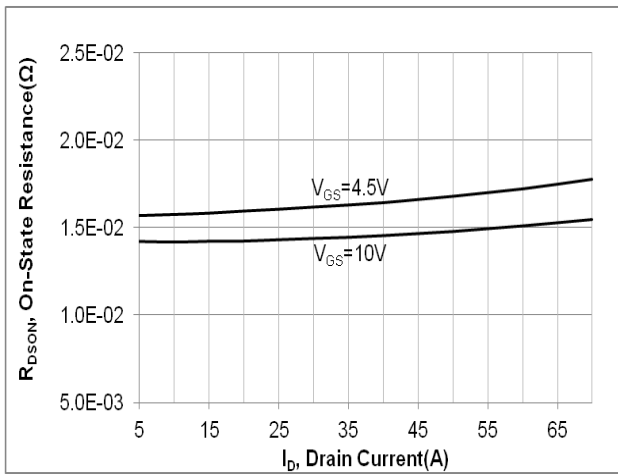

Fig. 4. On-state current vs. diode forward voltage

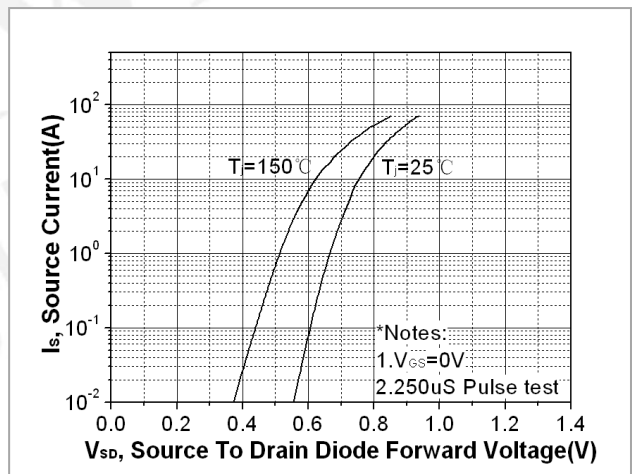

Fig 5. Breakdown voltage variation vs. junction temperature

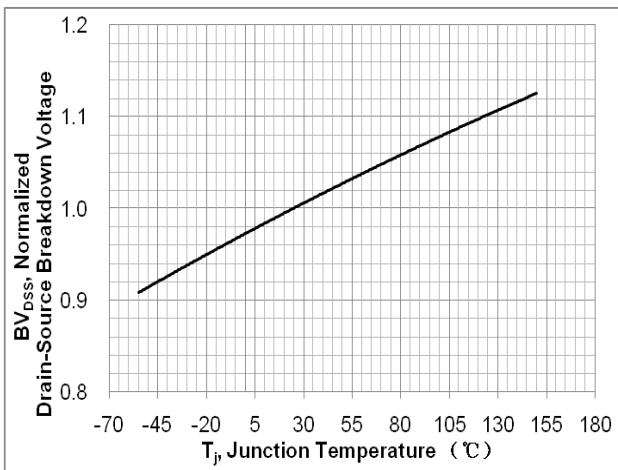

Fig. 6. On-resistance variation vs. junction temperature

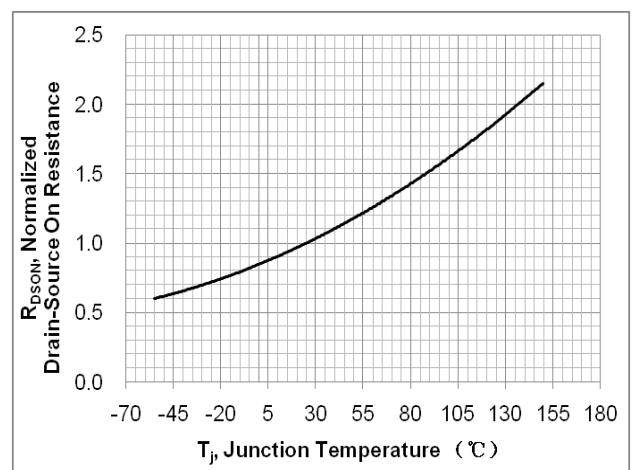

Fig. 7. Gate charge characteristics

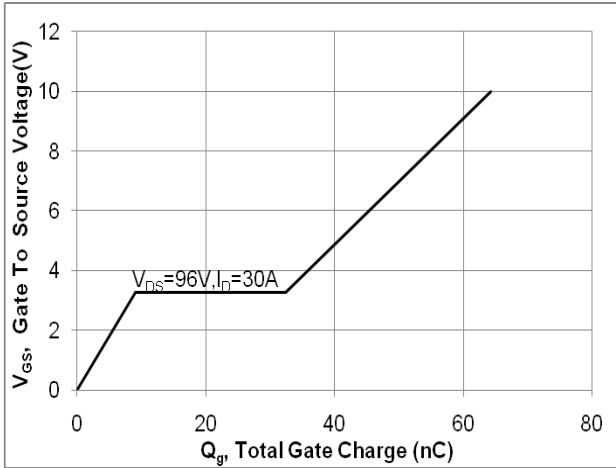

Fig. 8. Capacitance Characteristics

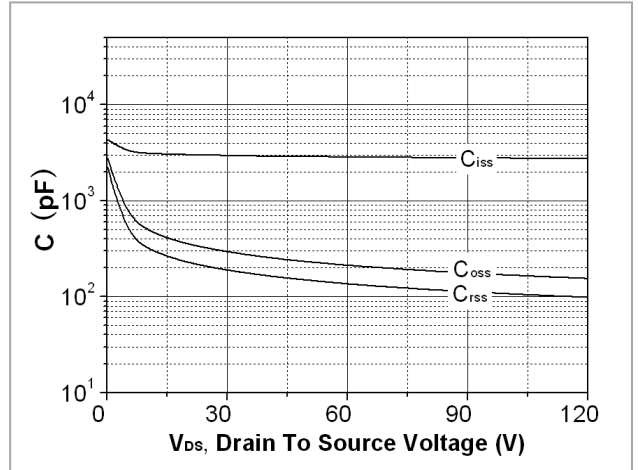

Fig. 9. Maximum safe operating area

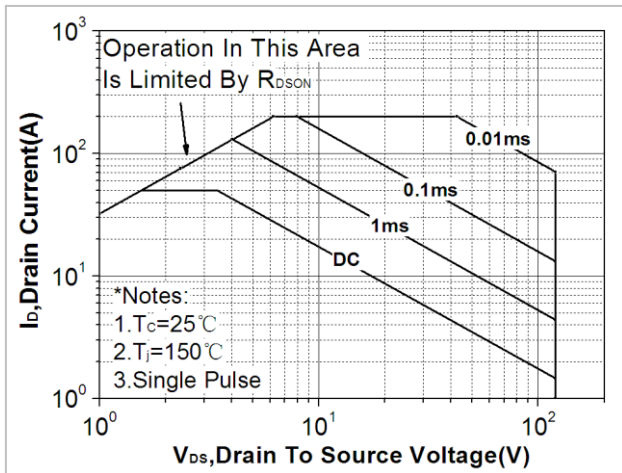

Fig. 10. Transient thermal response curve

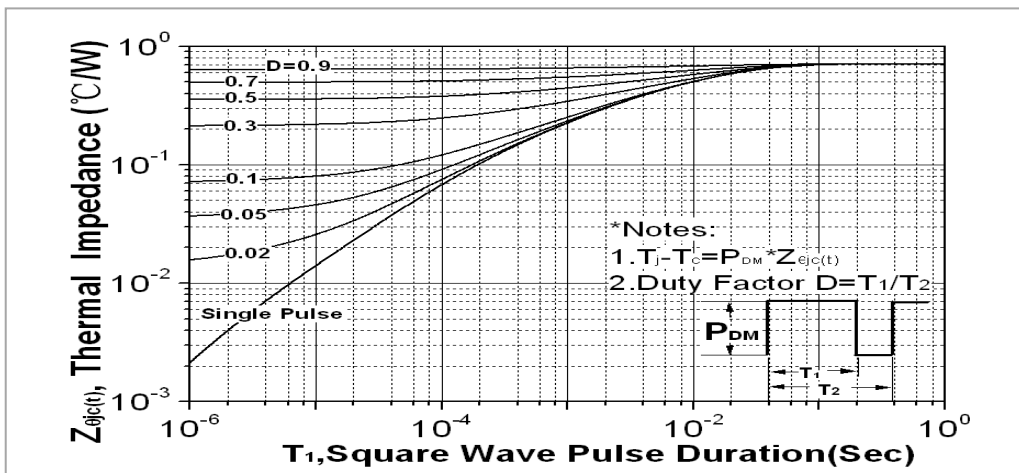
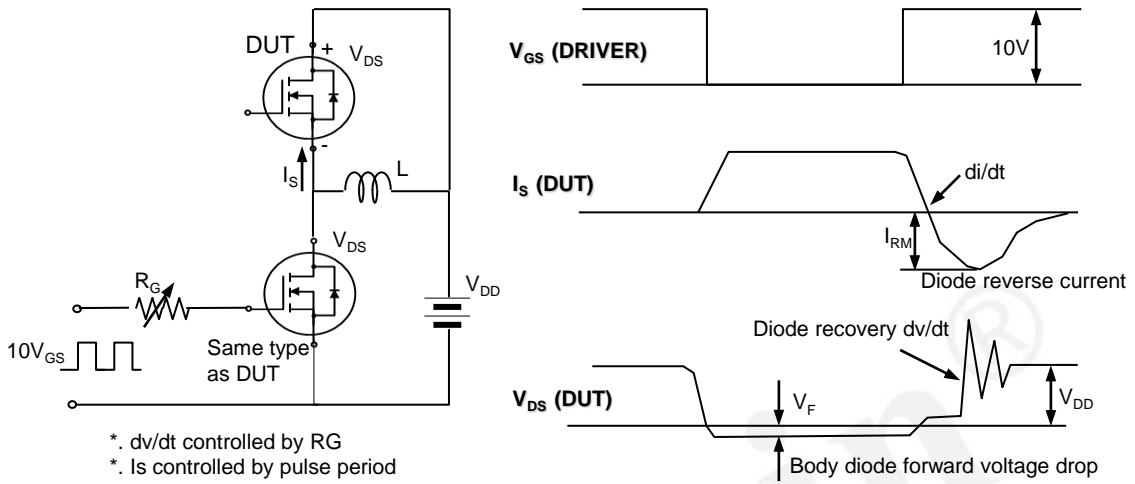



Fig. 14. Peak diode recovery dv/dt test circuit & waveform



DISCLAIMER

- * All the data & curve in this document was tested in SEMIPOWER TESTING & APPLICATION CENTER.
- * This product has passed the PCT,TC,HTRB,HTGB,HAST,PC and Solderdunk reliability testing.
- * Qualification standards can also be found on the Web site (<http://www.semipower.com.cn>) 
- * Suggestions for improvement are appreciated, Please send your suggestions to samwin@samwinsemi.com