

## N-channel Enhanced mode TO-220F/TO-220/TO-252 MOSFET

### Features

- High ruggedness
- Low  $R_{DS(ON)}$  (Typ 0.68Ω)@ $V_{GS}=10V$
- Low Gate Charge (Typ 31nC)
- Improved dv/dt Capability
- 100% Avalanche Tested
- Application: DC-DC, LED, PC

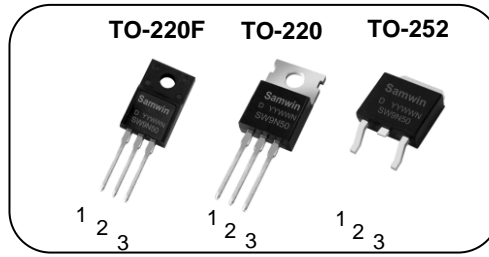

1. Gate 2. Drain 3. Source

$BV_{DSS} : 500V$

$I_D : 9A$

$R_{DS(ON)} : 0.68\Omega$

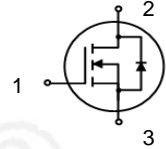

### General Description

This power MOSFET is produced with advanced technology of SAMWIN. This technology enable the power MOSFET to have better characteristics, including fast switching time, low on resistance, low gate charge and especially excellent avalanche characteristics.



### Order Codes

Item	Sales Type	Marking	Package	Packaging
1	SW F 9N50D	SW9N50D	TO-220F	TUBE
2	SW P 9N50D	SW9N50D	TO-220	TUBE
3	SW D 9N50D	SW9N50D	TO-252	REEL

### Absolute maximum ratings

Symbol	Parameter	Value			Unit
		TO-220F	TO-220	TO-252	
$V_{DSS}$	Drain to source voltage	500			V
$I_D$	Continuous drain current (@ $T_C=25^\circ C$ )	9*			A
	Continuous drain current (@ $T_C=100^\circ C$ )	5.7*			A
$I_{DM}$	Drain current pulsed (note 1)	36			A
$V_{GS}$	Gate to source voltage	$\pm 30$			V
$E_{AS}$	Single pulsed avalanche energy (note 2)	462			mJ
$E_{AR}$	Repetitive avalanche energy (note 1)	64			mJ
dv/dt	Peak diode recovery dv/dt (note 3)	5			V/ns
$P_D$	Total power dissipation (@ $T_C=25^\circ C$ )	23.3	200	181	W
	Derating factor above 25°C	0.19	1.6	1.4	W/°C
$T_{STG}, T_J$	Operating junction temperature & storage temperature	-55 ~ + 150			°C
$T_L$	Maximum lead temperature for soldering purpose, 1/8 from case for 5 seconds.	300			°C

\*. Drain current is limited by junction temperature.

### Thermal characteristics

Symbol	Parameter	Value			Unit
		TO-220F	TO-220	TO-252	
$R_{thjc}$	Thermal resistance, Junction to case	5.36	0.63	0.69	°C/W
$R_{thja}$	Thermal resistance, Junction to ambient	53	60		°C/W

Electrical characteristic (  $T_C = 25^\circ\text{C}$  unless otherwise specified )

Symbol	Parameter	Test conditions	Min.	Typ.	Max.	Unit
<b>Off characteristics</b>						
$BV_{DSS}$	Drain to source breakdown voltage	$V_{GS}=0V, I_D=250\mu A$	500			V
$\Delta BV_{DSS} / \Delta T_J$	Breakdown voltage temperature coefficient	$I_D=250\mu A$ , referenced to $25^\circ\text{C}$		0.57		$V/^\circ\text{C}$
$I_{DSS}$	Drain to source leakage current	$V_{DS}=510V, V_{GS}=0V$			1	$\mu A$
		$V_{DS}=408V, T_C=125^\circ\text{C}$			50	$\mu A$
$I_{GSS}$	Gate to source leakage current, forward	$V_{GS}=30V, V_{DS}=0V$			100	nA
	Gate to source leakage current, reverse	$V_{GS}=-30V, V_{DS}=0V$			-100	nA
<b>On characteristics</b>						
$V_{GS(TH)}$	Gate threshold voltage	$V_{DS}=V_{GS}, I_D=250\mu A$	2.5		4.5	V
$R_{DS(ON)}$	Drain to source on state resistance	$V_{GS}=10V, I_D=4.5A$		0.68	0.8	$\Omega$
$G_{fs}$	Forward transconductance	$V_{DS}=30V, I_D=4.5A$		7		S
<b>Dynamic characteristics</b>						
$C_{iss}$	Input capacitance	$V_{GS}=0V, V_{DS}=25V, f=1\text{MHz}$		1479		pF
$C_{oss}$	Output capacitance			126		
$C_{riss}$	Reverse transfer capacitance			22.4		
$t_{d(on)}$	Turn on delay time	$V_{DS}=250V, I_D=9A, R_G=25\Omega, V_{GS}=10V$ (note 4,5)		19		ns
$t_r$	Rising time			41		
$t_{d(off)}$	Turn off delay time			74		
$t_f$	Fall time			37		
$Q_g$	Total gate charge	$V_{DS}=400V, V_{GS}=10V, I_D=9A$ (note 4,5)		31		nC
$Q_{gs}$	Gate-source charge			7		
$Q_{gd}$	Gate-drain charge			13		
$R_g$	Gate resistance	$V_{DS}=0V$ , Scan F mode		1.7		$\Omega$

### Source to drain diode ratings characteristics

Symbol	Parameter	Test conditions	Min.	Typ.	Max.	Unit
$I_S$	Continuous source current	Integral reverse p-n Junction diode in the MOSFET			9	A
$I_{SM}$	Pulsed source current				36	A
$V_{SD}$	Diode forward voltage drop.	$I_S=9A, V_{GS}=0V$			1.4	V
$t_{rr}$	Reverse recovery time	$I_S=9A, V_{GS}=0V,$		319		ns
$Q_{rr}$	Reverse recovery charge	$di/dt=100A/\mu s$		3.48		$\mu C$

※. Notes

1. Repetitive rating : pulse width limited by junction temperature.
2.  $L = 11.4\text{mH}, I_{AS} = 9A, V_{DD} = 50V, R_G=25\Omega$ , Starting  $T_J = 25^\circ\text{C}$
3.  $I_{SD} \leq 9A, di/dt = 100A/\mu s, V_{DD} \leq BV_{DSS}$ , Starting  $T_J = 25^\circ\text{C}$
4. Pulse Test : Pulse Width  $\leq 300\mu s$ , duty cycle  $\leq 2\%$ .
5. Essentially independent of operating temperature.

**Fig. 1. On-state characteristics**

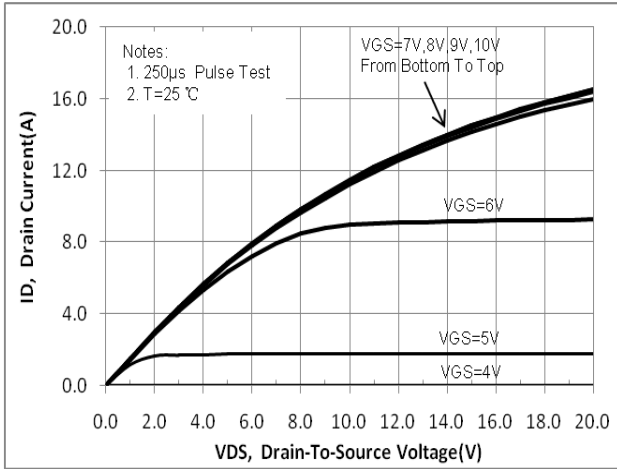

**Fig. 2. Transfer Characteristics**

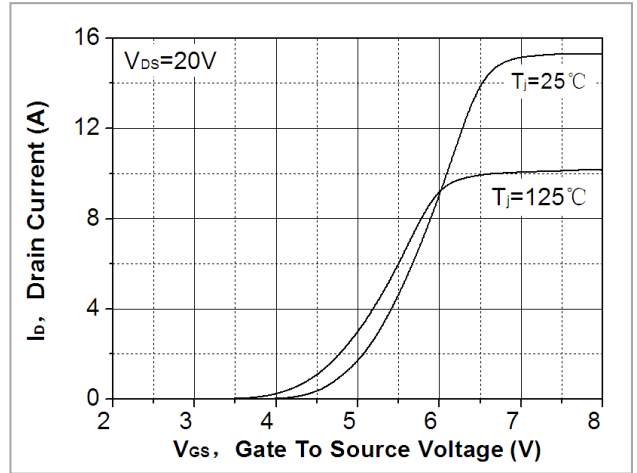

**Fig. 3. On-resistance variation vs. drain current and gate voltage**

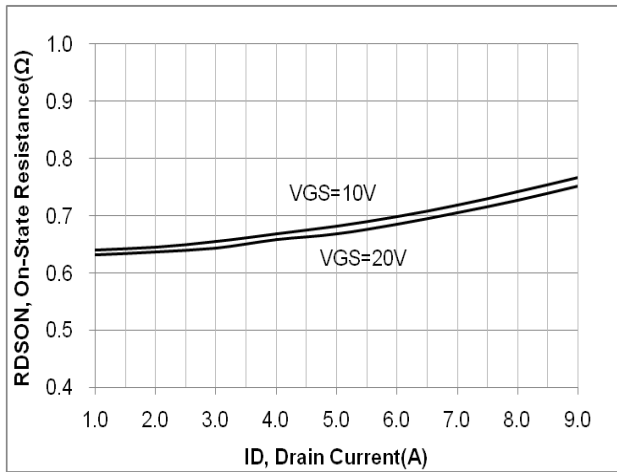

**Fig. 4. On state current vs. diode forward voltage**

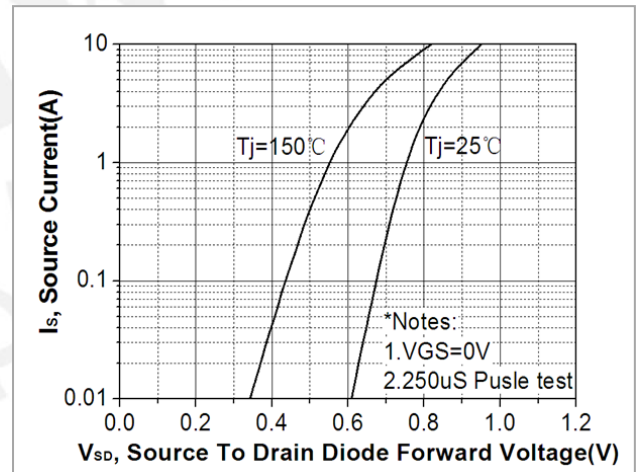

**Fig 5. Breakdown Voltage Variation vs. Junction Temperature**

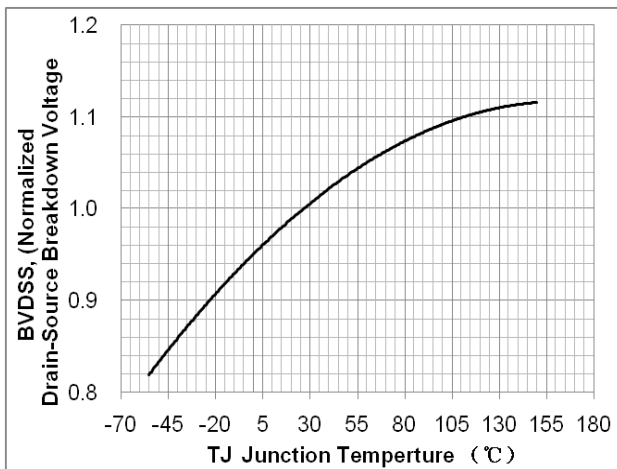

**Fig. 6. On resistance variation vs. junction temperature**

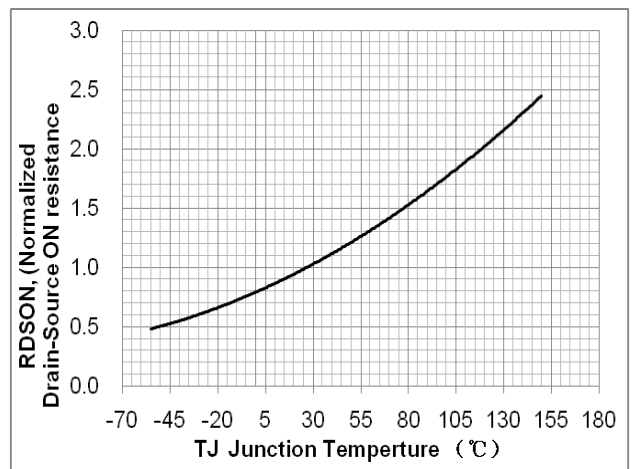

Fig. 7. Gate charge characteristics

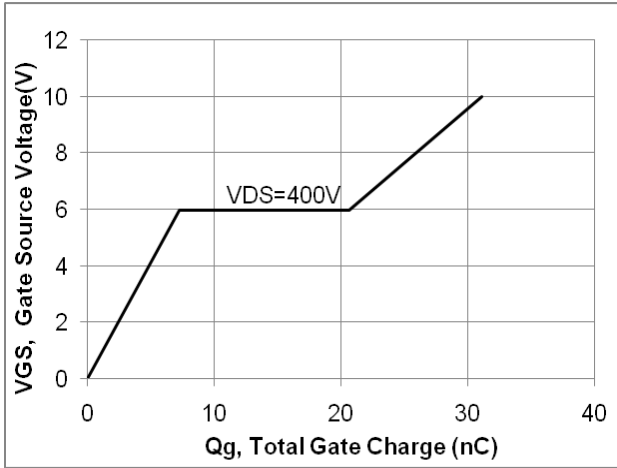

Fig. 8. Capacitance Characteristics

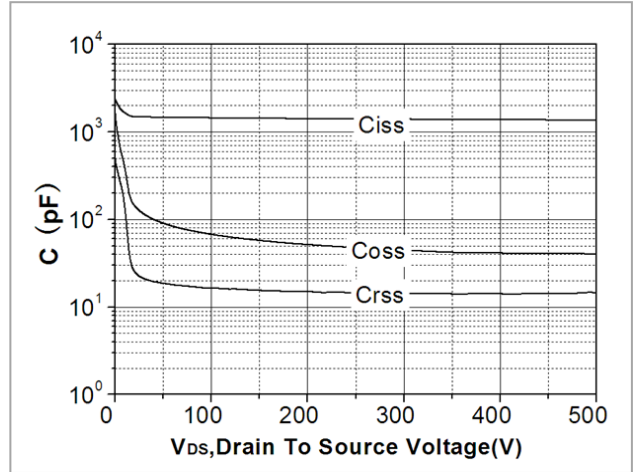

Fig. 9. Maximum safe operating area(TO-220F)

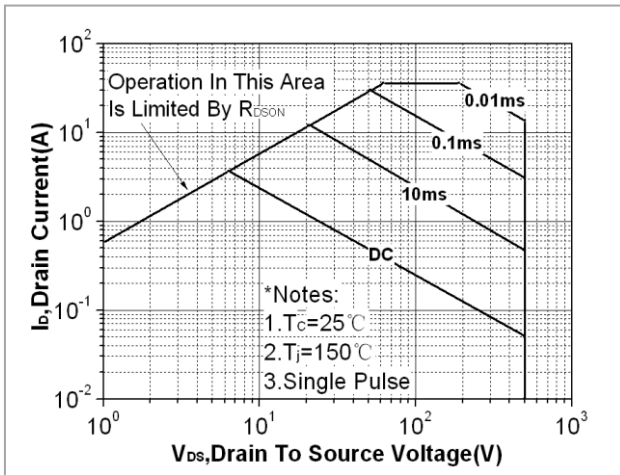

Fig. 10. Maximum safe operating area(TO-220)

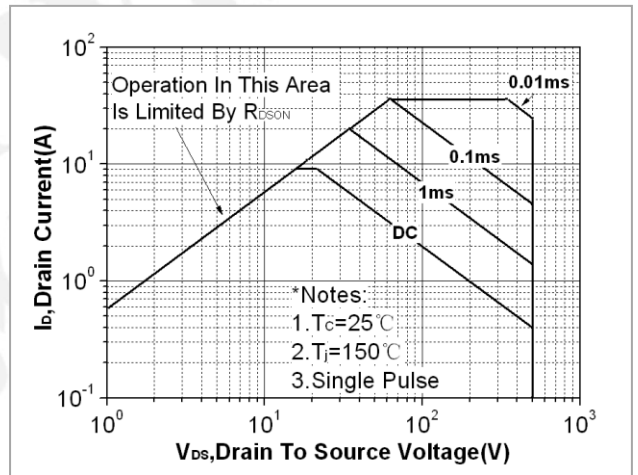

Fig. 11. Maximum safe operating area(TO-252)

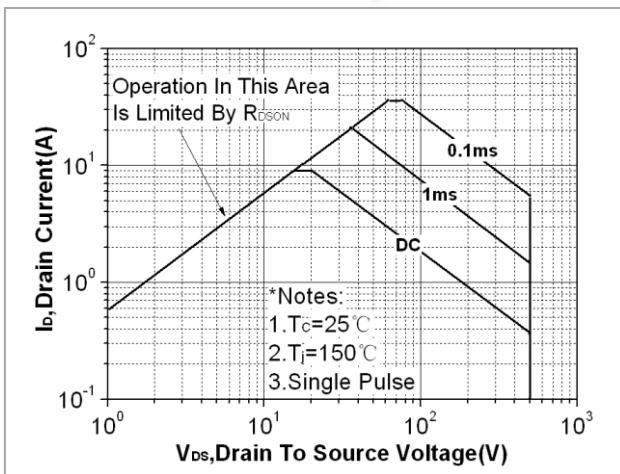

Fig. 12. Transient thermal response curve(TO-220F)

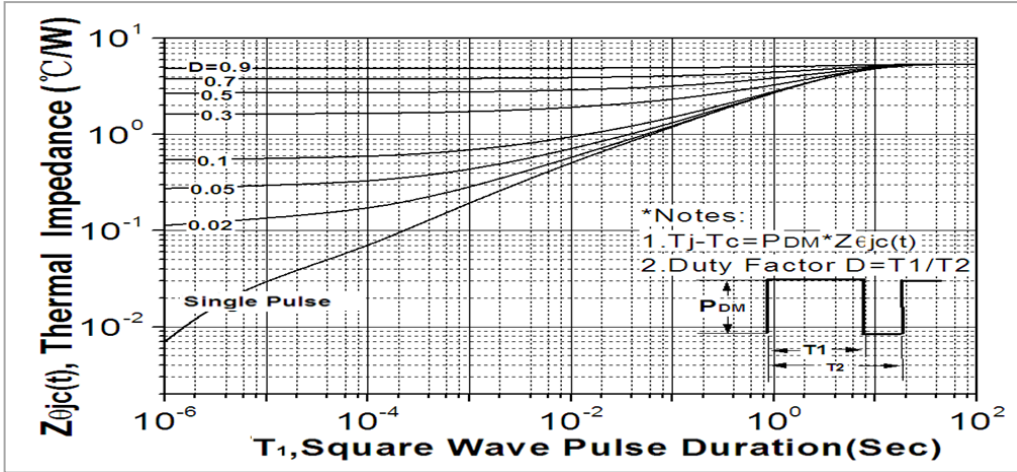

Fig. 13. Transient thermal response curve(TO-220)

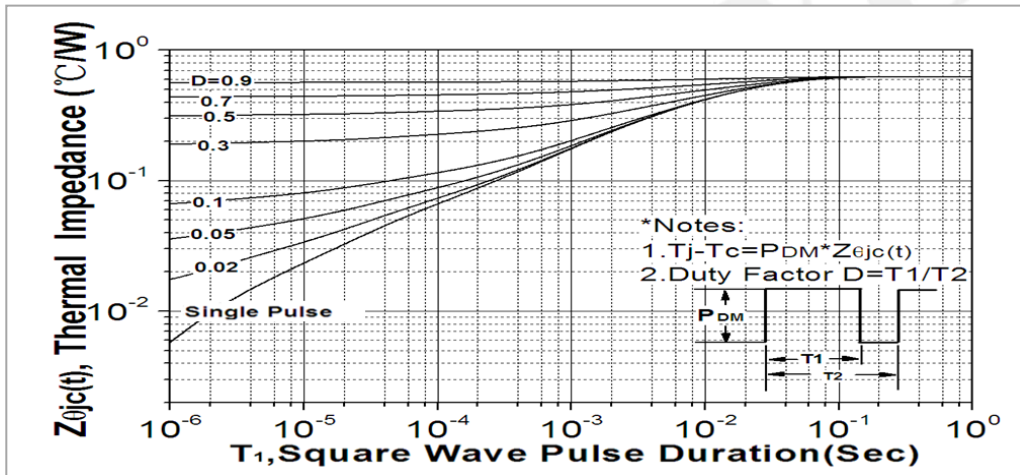

Fig. 14. Transient thermal response curve(TO-252)

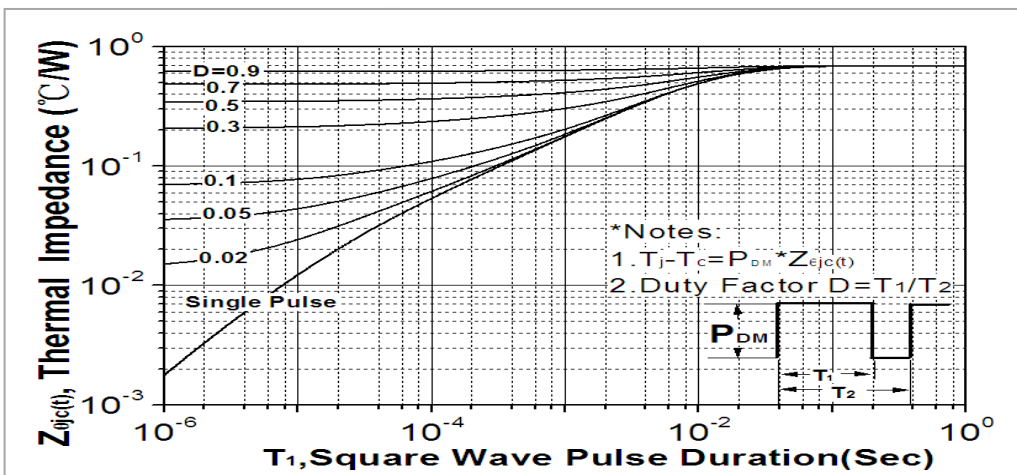

Fig. 15. Gate charge test circuit & waveform

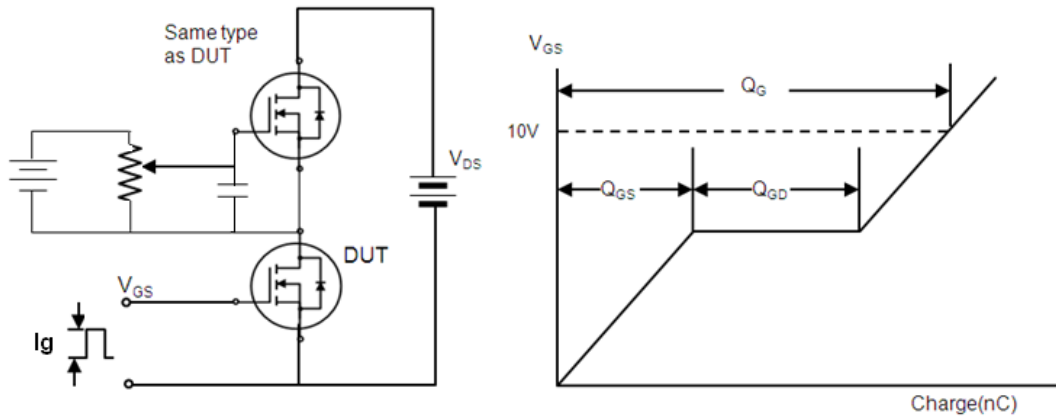

Fig. 16. Switching time test circuit & waveform

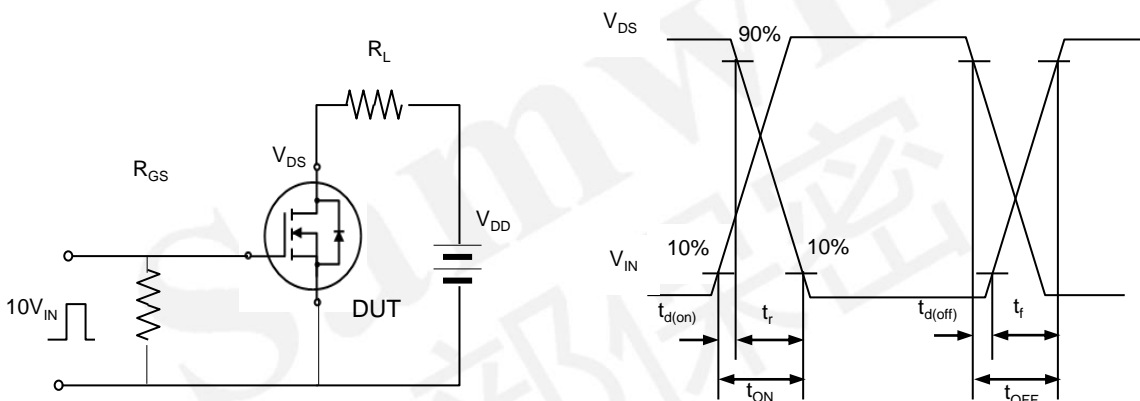

Fig. 17. Unclamped Inductive switching test circuit & waveform

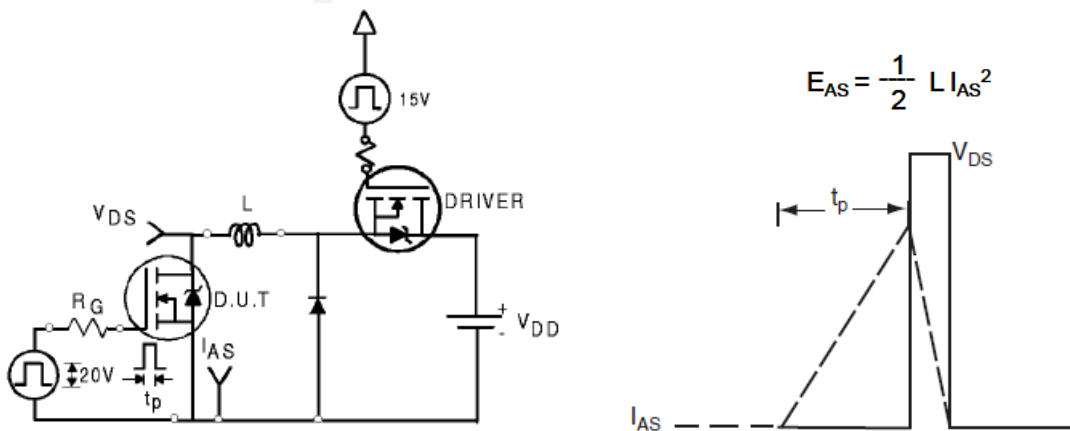
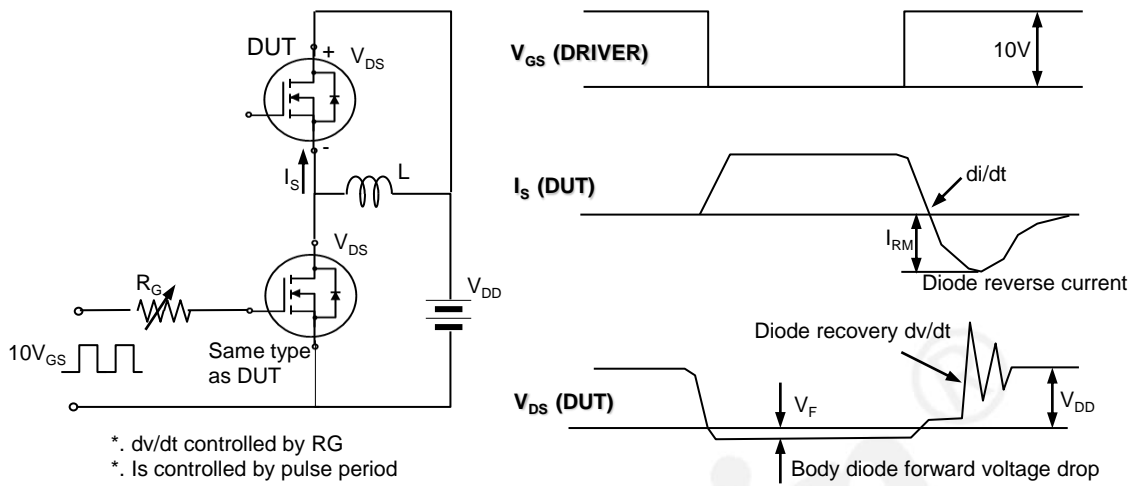



Fig. 18. Peak diode recovery dv/dt test circuit & waveform



## DISCLAIMER

- \* All the data & curve in this document was tested in SEMIPOWER TESTING & APPLICATION CENTER.
- \* This product has passed the PCT,TC,HTRB,HTGB,HAST,PC and Solderdunk reliability testing.
- \* Qualification standards can also be found on the Web site (<http://www.semipower.com.cn>) 
- \* Suggestions for improvement are appreciated, Please send your suggestions to [samwin@samwinsemi.com](mailto:samwin@samwinsemi.com)