

N-channel Enhanced mode TO-220/TO-251/TO-251N/TO-251U/TO-252/TO-220F/TO-220SF/TO-262N/DFN5*6/TO-220FT MOSFET

Features

- High ruggedness
- Low $R_{DS(ON)}$ (Typ 1.1Ω)
@ $V_{GS}=10V$
- Low Gate Charge (Typ 30nC)
- Improved dv/dt Capability
- 100% Avalanche Tested
- Application:Charger,LED, PC Power

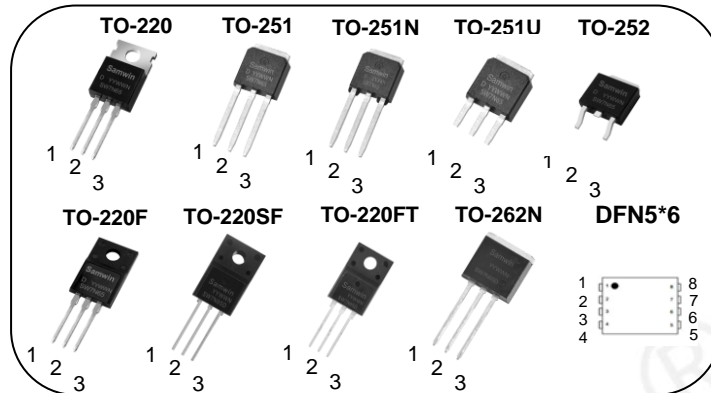

TO-220(F/SF)&TO-251(N)&TO-252&TO-262N : 1. Gate 2. Drain 3. Source
DFN5*6 : 4. Gate 5,6,7,8. Drain 1,2,3,4. Source

BV_{DSS} : 650V
 I_D : 7A
 $R_{DS(ON)}$: 1.1Ω

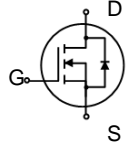

General Description

This power MOSFET is produced with advanced technology of SAMWIN. This technology enable the power MOSFET to have better characteristics, including fast switching time, low on resistance, low gate charge and especially excellent avalanche characteristics.

Order Codes

Item	Sales Type	Marking	Package	Packaging
1	SW P 7N65D	SW7N65D	TO-220	TUBE
2	SW I 7N65D	SW7N65D	TO-251	TUBE
3	SW N 7N65D	SW7N65D	TO-251N	TUBE
4	SW UI 7N65D	SW7N65D	TO-251U	TUBE
5	SW D 7N65D	SW7N65D	TO-252	REEL
6	SW F 7N65D	SW7N65D	TO-220F	TUBE
7	SW MN 7N65D	SW7N65D	TO-220SF	TUBE
8	SW J 7N65D	SW7N65D	TO-262N	TUBE
9	SW HA 7N65D	SW7N65D	DFN5*6	REEL
10	SW Y 7N65D	SW7N65D	TO-220FT	TUBE

Absolute maximum ratings

Symbol	Parameter	Value					Unit
		TO220	TO251/TO251N/TO251U	TO252	TO220F/TO220SF/TO220FT	TO262N	
V_{DSS}	Drain to source voltage	650					V
I_D	Continuous drain current (@ $T_C=25^\circ C$)	7*					A
	Continuous drain current (@ $T_C=100^\circ C$)	4.4*					A
I_{DM}	Drain current pulsed (note 1)	28					A
V_{GS}	Gate to source voltage	± 30					V
E_{AS}	Single pulsed avalanche energy (note 2)	430					mJ
E_{AR}	Repetitive avalanche energy (note 1)	40					mJ
dv/dt	Peak diode recovery dv/dt (note 3)	5					V/ns
P_D	Total power dissipation (@ $T_C=25^\circ C$)	208.3	173.6	27.8	186.6		W
	Total power dissipation (@ $T_a=25^\circ C$)					2.4	W
	Derating factor above 25°C	1.67	1.39	0.22	1.5	0.02	W/°C
T_{STG}, T_J	Operating junction temperature & storage temperature	-55 ~ + 150					°C
T_L	Maximum lead temperature for soldering purpose, 1/8 from case for 5 seconds.	300					°C

*. Drain current is limited by junction temperature.

Thermal characteristics

Symbol	Parameter	Value						Unit
		TO220	TO251/TO251N/TO251U	TO252	TO220F/TO220SF/TO220FT	TO262N	DFN5*6	
R_{thjc}	Thermal resistance, Junction to case	0.6	0.72		4.5	0.67		°C/W
R_{thja}	Thermal resistance, Junction to ambient	60	82		50	61	51.4	°C/W

Note: R_{thja} is the sum of the junction-to-case and case-to-ambient thermal resistance where the case thermal reference is defined as the solder mounting surface of the drain pins. R_{thjc} is guaranteed by design while R_{thca} is determined by the user's board design.

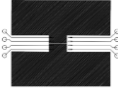

DFN5*6 R_{thja} : 51.4°C/W on a 1 in² pad of 2oz copper.

Electrical characteristic ($T_J = 25^\circ\text{C}$ unless otherwise specified)

Symbol	Parameter	Test conditions	Min.	Typ.	Max.	Unit
Off characteristics						
BV_{DSS}	Drain to source breakdown voltage	$V_{GS}=0V, I_D=250\mu A$	650			V
$\Delta BV_{DSS} / \Delta T_J$	Breakdown voltage temperature coefficient	$I_D=250\mu A$, referenced to 25°C		0.51		V/°C
I_{DSS}	Drain to source leakage current	$V_{DS}=650V, V_{GS}=0V$			1	μA
		$V_{DS}=520V, T_J=125^\circ\text{C}$			50	μA
I_{GSS}	Gate to source leakage current, forward	$V_{GS}=30V, V_{DS}=0V$			100	nA
	Gate to source leakage current, reverse	$V_{GS}=-30V, V_{DS}=0V$			-100	nA
On characteristics						
$V_{GS(TH)}$	Gate threshold voltage	$V_{DS}=V_{GS}, I_D=250\mu A$	2.5		4.5	V
$R_{DS(ON)}$	Drain to source on state resistance	$V_{GS}=10V, I_D = 3.5A, T_J=25^\circ\text{C}$		1.1	1.4	Ω
		$V_{GS}=10V, I_D = 3.5A, T_J=125^\circ\text{C}$		2.4		Ω
G_{fs}	Forward transconductance	$V_{DS}=30V, I_D = 3.5A$		6.3		S
Dynamic characteristics						
C_{iss}	Input capacitance	$V_{GS}=0V, V_{DS}=25V, f=1\text{MHz}$		1230		pF
C_{oss}	Output capacitance			108		
C_{riss}	Reverse transfer capacitance			16		
$t_{d(on)}$	Turn on delay time	$V_{DS}=350V, I_D=7A, R_G=25\Omega$ (note 4,5)		16		ns
t_r	Rising time			36		
$t_{d(off)}$	Turn off delay time			83		
t_f	Fall time			40		
Q_g	Total gate charge	$V_{DS}=520V, V_{GS}=10V, I_D=7A$ (note 4,5)		30		nC
Q_{gs}	Gate-source charge			5		
Q_{gd}	Gate-drain charge			15		
R_g	Gate resistance		$V_{DS}=0V$, Scan F mode		1.7	

Source to drain diode ratings characteristics

Symbol	Parameter	Test conditions	Min.	Typ.	Max.	Unit
I_S	Continuous source current	Integral reverse p-n Junction diode in the MOSFET			7	A
I_{SM}	Pulsed source current				28	A
V_{SD}	Diode forward voltage drop.	$I_S=7A, V_{GS}=0V$			1.4	V
t_{rr}	Reverse recovery time	$I_S=7A, V_{GS}=0V,$ $di_F/dt=100A/\mu s$		436		ns
Q_{rr}	Reverse recovery charge			3.6		μC

※. Notes

1. Repetitive rating : pulse width limited by junction temperature.
2. $L = 17.5\text{mH}, I_{AS} = 7A, V_{DD} = 50V, R_G=25\Omega$, Starting $T_J = 25^\circ\text{C}$
3. $I_{SD} \leq 7A, di/dt = 100A/\mu s, V_{DD} \leq BV_{DSS}$, Starting $T_J = 25^\circ\text{C}$
4. Pulse Test : Pulse Width $\leq 300\mu s$, duty cycle $\leq 2\%$.
5. Essentially independent of operating temperature.

Fig. 1. On-state characteristics

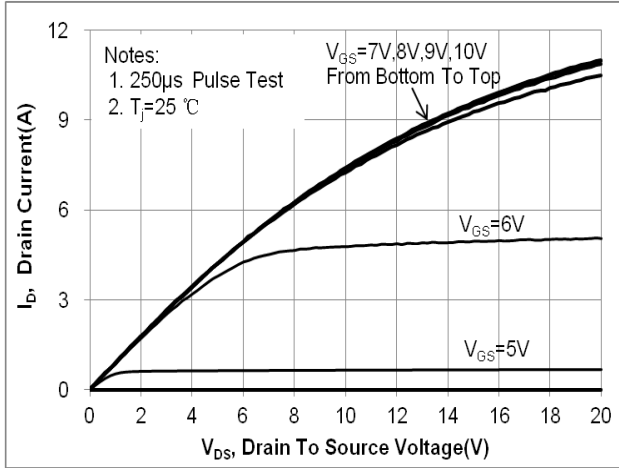

Fig. 2. Transfer Characteristics

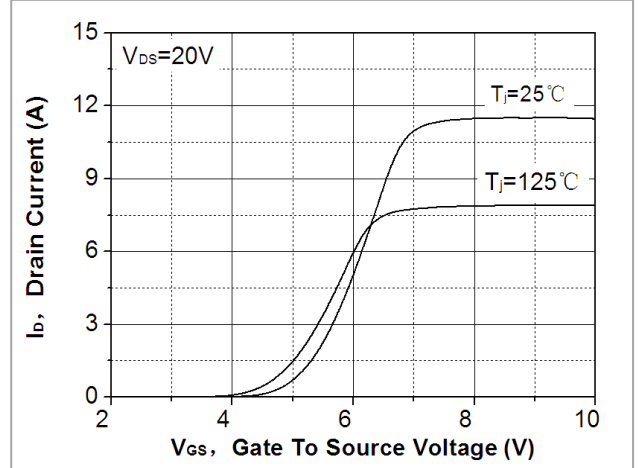

Fig. 3. On-resistance variation vs. drain current and gate voltage

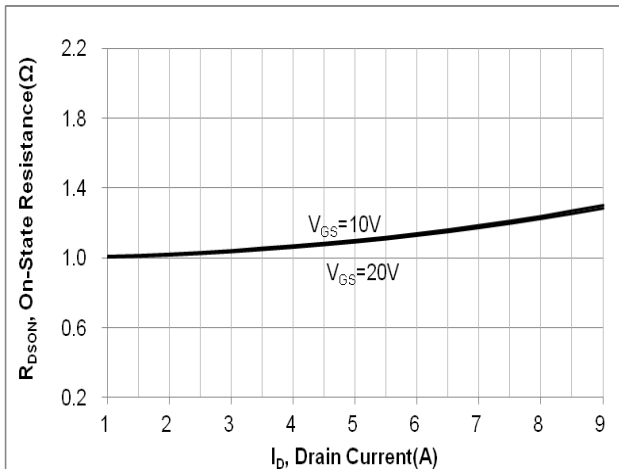

Fig. 4. On-state current vs. diode forward voltage

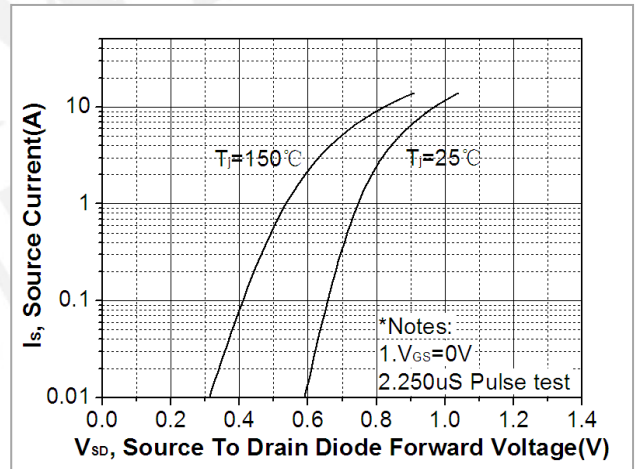

Fig 5. Breakdown Voltage Variation vs. Junction Temperature

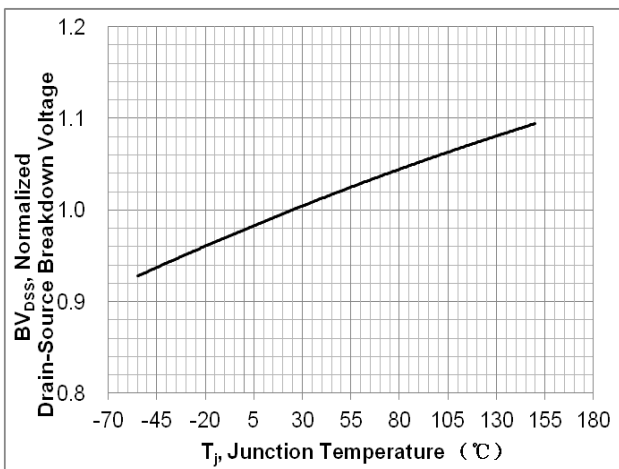

Fig. 6. On resistance variation vs. junction temperature

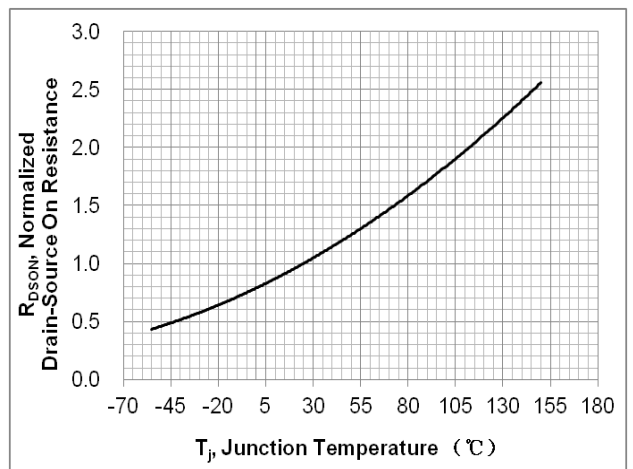

Fig. 7. Gate charge characteristics

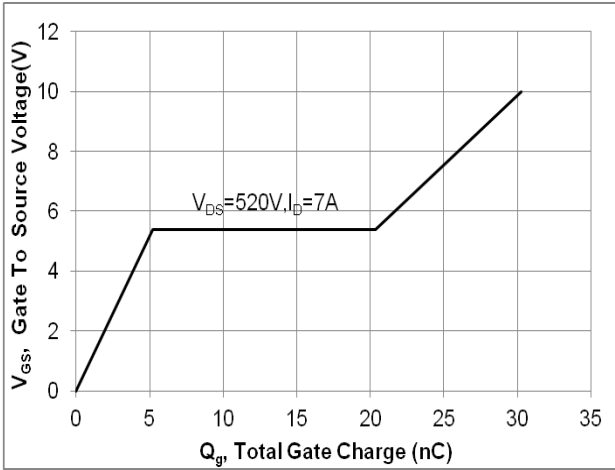

Fig. 8. Capacitance Characteristics

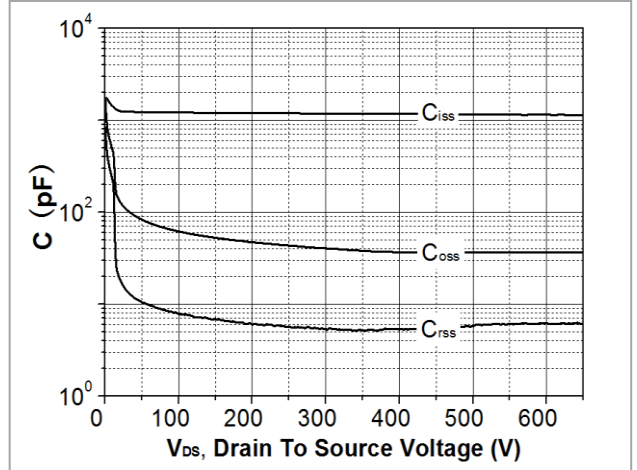

Fig. 9. Maximum safe operating area(TO-220)

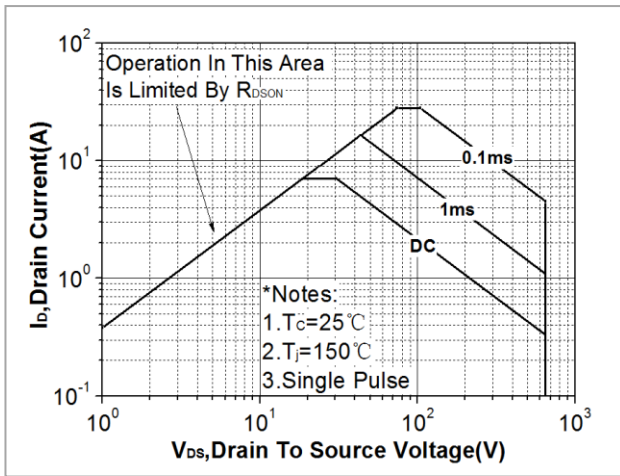

Fig. 10. Maximum safe operating area (TO-251/TO-251N/TO-251U/TO-252)

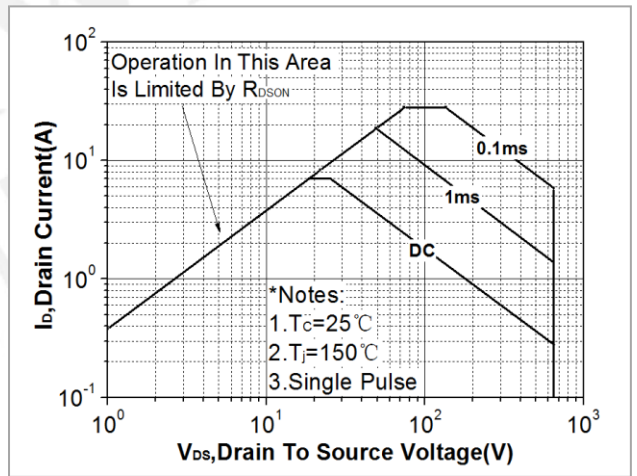

Fig. 11. Maximum safe operating area (TO-220F/TO-220SF/TO-220FT)

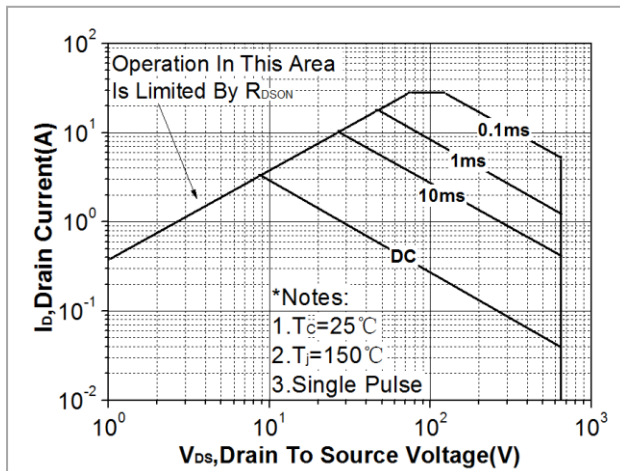

Fig. 12. Maximum safe operating area(TO-262N)

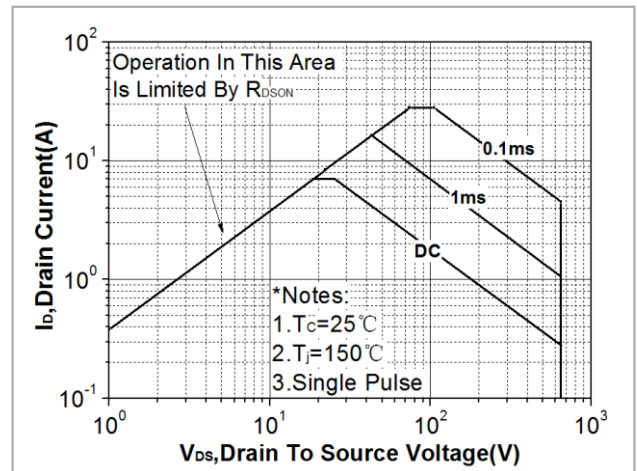

Fig. 13. Maximum safe operating area(DFN5*6)

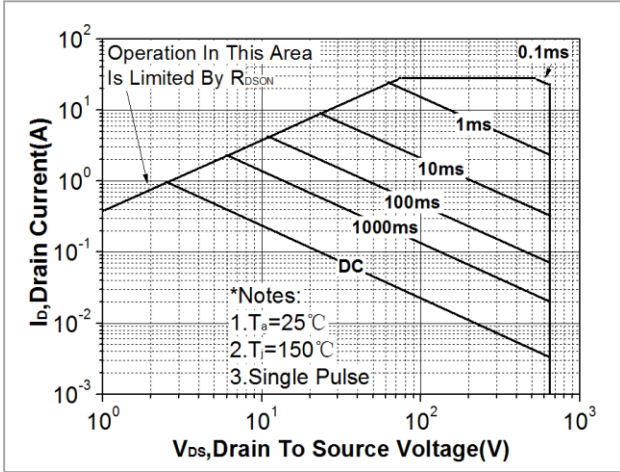

Fig. 14. Transient thermal response curve(TO-220)

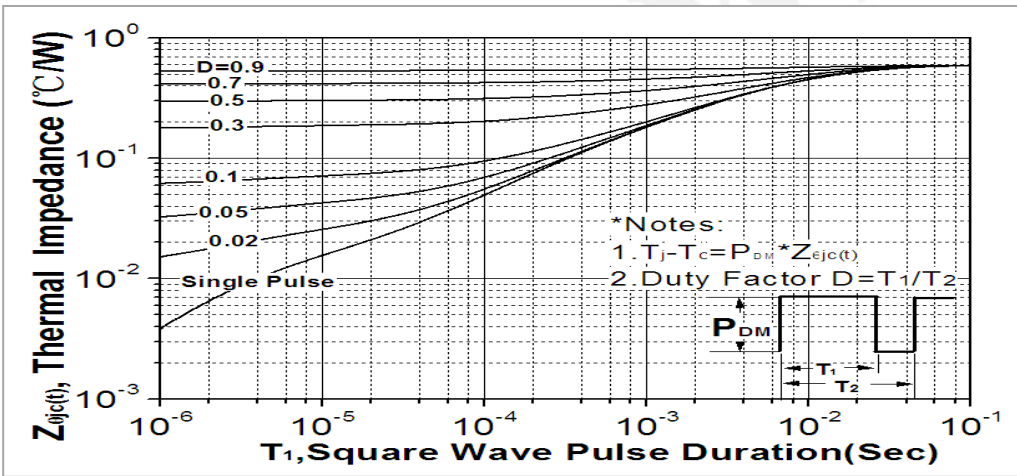

Fig. 15. Transient thermal response curve (TO-251/TO-251N/TO-251U/TO-252)

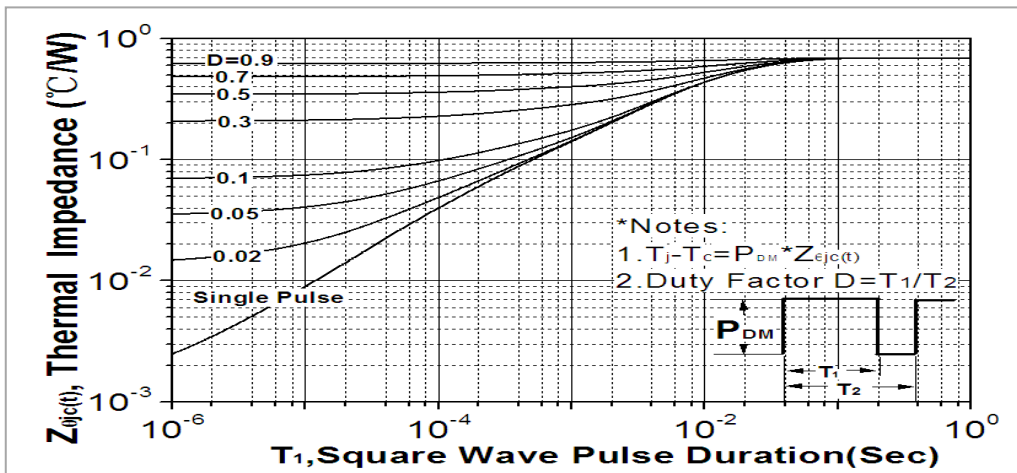

Fig. 16. Transient thermal response curve(TO-220F/TO-220SF/TO-220FT)

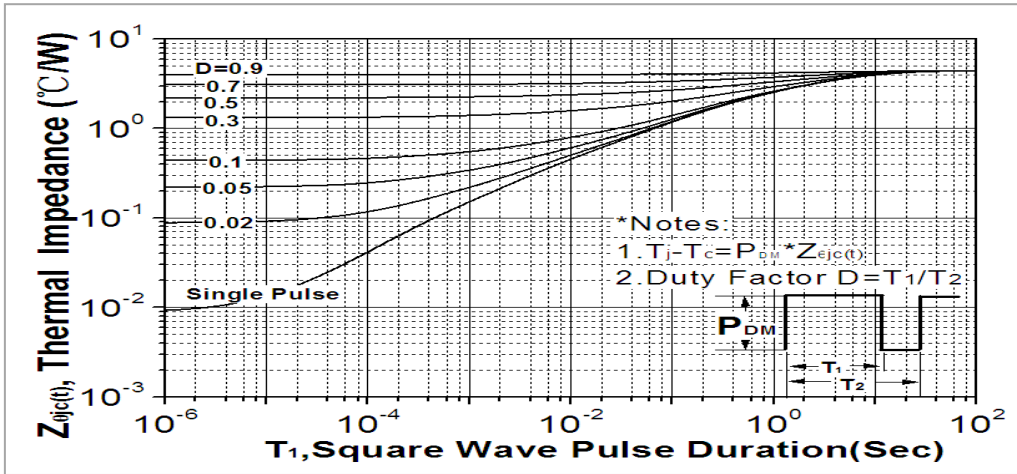

Fig. 17. Transient thermal response curve(TO-262N)

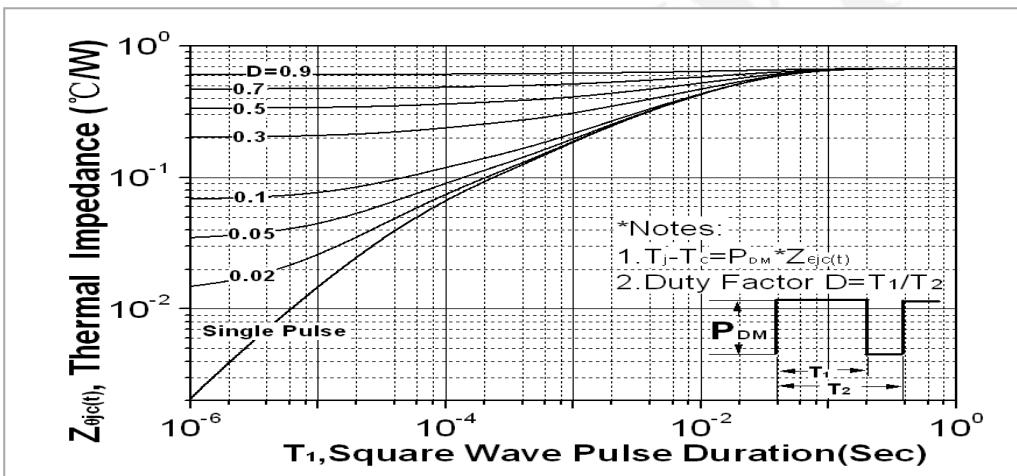

Fig. 18. Transient thermal response curve(DFN5*6)

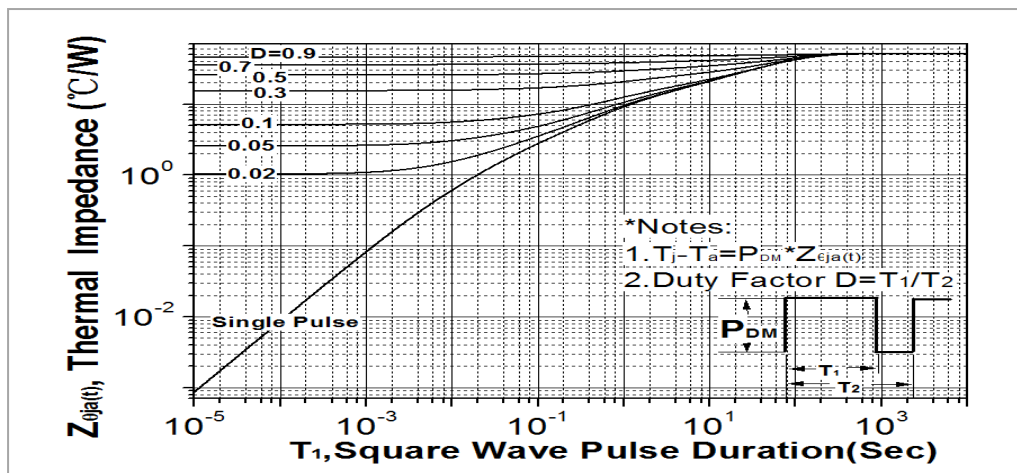

Fig. 19. Gate charge test circuit & waveform

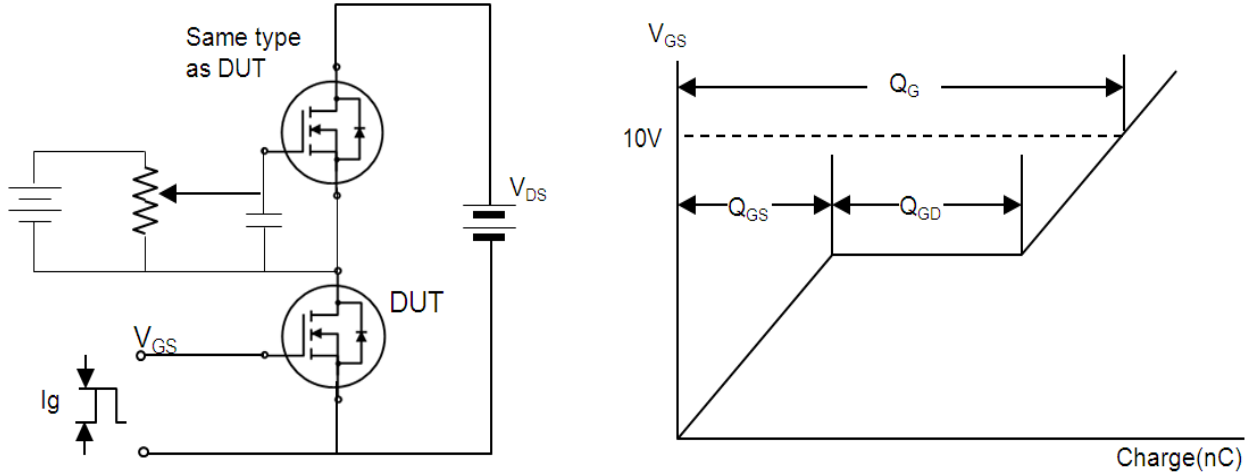

Fig. 20. Switching time test circuit & waveform

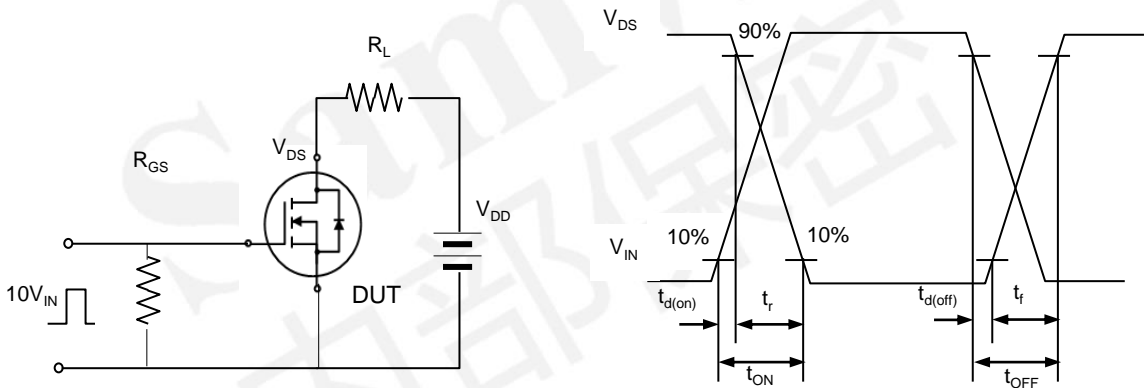

Fig. 21. Unclamped Inductive switching test circuit & waveform

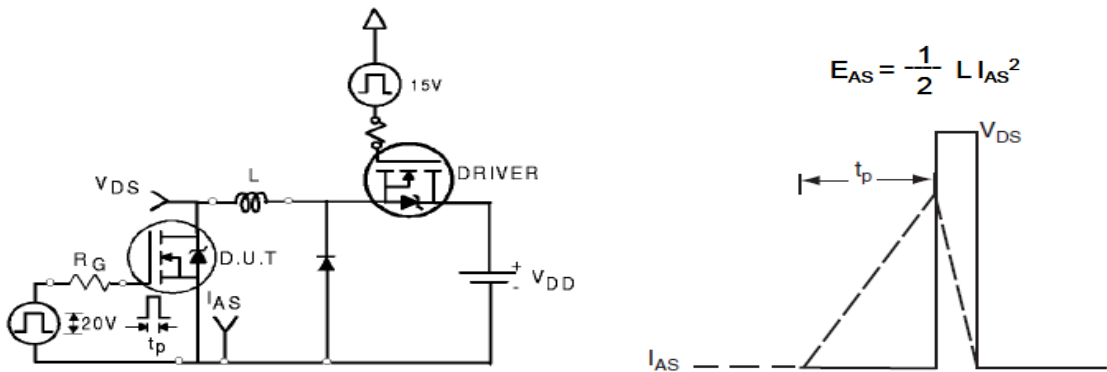
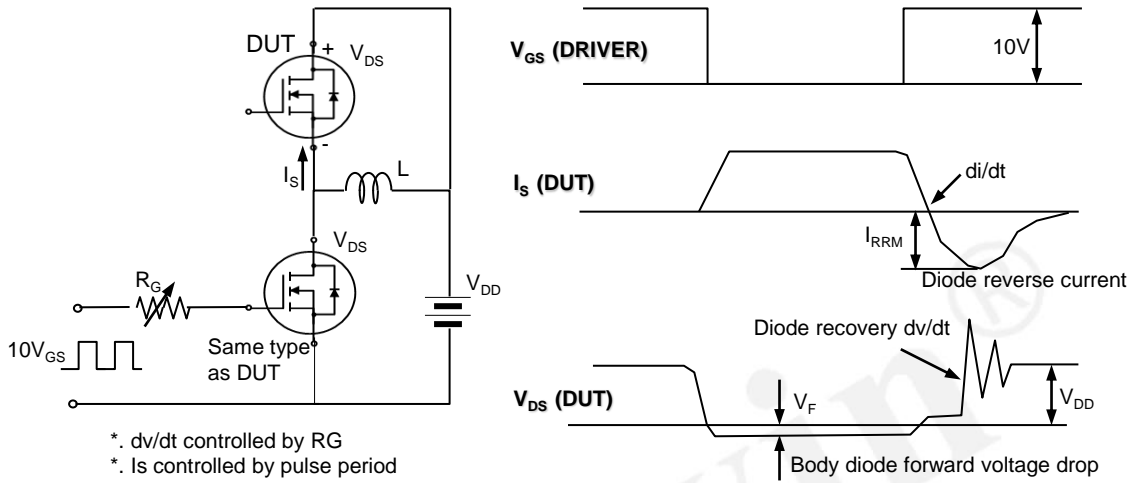

Fig. 22. Peak diode recovery dv/dt test circuit & waveform



DISCLAIMER

* All the data & curve in this document was tested in SEMIPOWER TESTING & APPLICATION CENTER.

* This product has passed the PCT,TC,HTRB,HTGB,HAST,PC and Solderdunk reliability testing.

* Qualification standards can also be found on the Web site (<http://www.semipower.com.cn>) 

* Suggestions for improvement are appreciated, Please send your suggestions to samwin@samwinsemi.com