

N-channel Enhanced mode TO-220/TO-220F/TO-252 MOSFET

Features

- High ruggedness
- Low $R_{DS(ON)}$ (Typ 0.4Ω) @ $V_{GS}=10V$
- Low Gate Charge (Typ 35nC)
- Improved dv/dt Capability
- 100% Avalanche Tested
- Application: LED, DC-DC

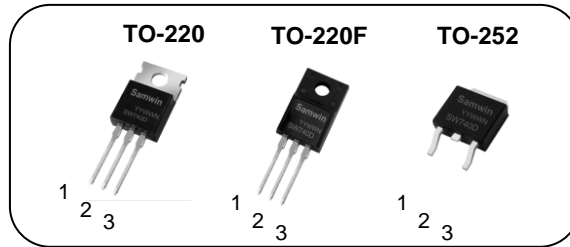

1. Gate 2. Drain 3. Source

BV_{DSS} : 400V

I_D : 10A

$R_{DS(ON)}$: 0.4Ω

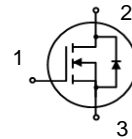

General Description

This power MOSFET is produced with advanced technology of SAMWIN.

This technology enable the power MOSFET to have better characteristics, including fast switching time, low on resistance, low gate charge and especially excellent avalanche characteristics.



Order Codes

Item	Sales Type	Marking	Package	Packaging
1	SW P 740D	SW740D	TO-220	TUBE
2	SW F 740D	SW740D	TO-220F	TUBE
3	SW D 740D	SW740D	TO-252	REEL

Absolute maximum ratings

Symbol	Parameter	Value			Unit
		TO-220	TO-220F	TO-252	
V_{DSS}	Drain to source voltage	400			V
I_D	Continuous drain current (@ $T_C=25^\circ C$)	10*			A
	Continuous drain current (@ $T_C=100^\circ C$)	6.3*			A
I_{DM}	Drain current pulsed (note 1)	40			A
V_{GS}	Gate to source voltage	±30			V
E_{AS}	Single pulsed avalanche energy (note 2)	405			mJ
E_{AR}	Repetitive avalanche energy (note 1)	40			mJ
dv/dt	Peak diode recovery dv/dt (note 3)	5			V/ns
P_D	Total power dissipation (@ $T_C=25^\circ C$)	183.8	23.6	119	W
	Derating factor above 25°C	1.5	0.2	0.95	W/°C
T_{STG}, T_J	Operating junction temperature & storage temperature	-55 ~ + 150			°C
T_L	Maximum lead temperature for soldering purpose, 1/8 from case for 5 seconds.	300			°C

*. Drain current is limited by junction temperature.

Thermal characteristics

Symbol	Parameter	Value			Unit
		TO-220	TO-220F	TO-252	
R_{thjc}	Thermal resistance, Junction to case	0.68	5.3	1.05	°C/W
R_{thja}	Thermal resistance, Junction to ambient	58	50		°C/W

Electrical characteristic ($T_J = 25^\circ\text{C}$ unless otherwise specified)

Symbol	Parameter	Test conditions	Min.	Typ.	Max.	Unit
Off characteristics						
BV_{DSS}	Drain to source breakdown voltage	$V_{GS}=0V, I_D=250\mu A$	400			V
$\Delta BV_{DSS} / \Delta T_J$	Breakdown voltage temperature coefficient	$I_D=250\mu A$, referenced to 25°C		0.54		V/ $^\circ\text{C}$
I_{DSS}	Drain to source leakage current	$V_{DS}=400V, V_{GS}=0V$			1	μA
		$V_{DS}=320V, T_J=125^\circ\text{C}$			50	μA
I_{GSS}	Gate to source leakage current, forward	$V_{GS}=30V, V_{DS}=0V$			100	nA
	Gate to source leakage current, reverse	$V_{GS}=-30V, V_{DS}=0V$			-100	nA
On characteristics						
$V_{GS(TH)}$	Gate threshold voltage	$V_{DS}=V_{GS}, I_D=250\mu A$	2.5		4.5	V
$R_{DS(ON)}$	Drain to source on state resistance	$V_{GS}=10V, I_D=5A, T_J=25^\circ\text{C}$		0.4	0.5	Ω
		$V_{GS}=10V, I_D=5A, T_J=125^\circ\text{C}$		0.9		Ω
G_{fs}	Forward transconductance	$V_{DS}=30V, I_D=5A$		8.5		S
Dynamic characteristics						
C_{iss}	Input capacitance	$V_{GS}=0V, V_{DS}=25V, f=1\text{MHz}$		1358		pF
C_{oss}	Output capacitance			161		
C_{rss}	Reverse transfer capacitance			20		
$t_{d(on)}$	Turn on delay time	$V_{DS}=200V, I_D=10A, R_G=10\Omega, V_{GS}=10V$ (note 4,5)		18		ns
t_r	Rising time			44		
$t_{d(off)}$	Turn off delay time			47		
t_f	Fall time			31		
Q_g	Total gate charge	$V_{DS}=320V, V_{GS}=10V, I_D=10A, I_G=3\text{mA}$ (note 4,5)		35		nC
Q_{gs}	Gate-source charge			8		
Q_{gd}	Gate-drain charge			15		
R_g	Gate resistance	$V_{DS}=0V$, Scan F mode		1.7		Ω

Source to drain diode ratings characteristics

Symbol	Parameter	Test conditions	Min.	Typ.	Max.	Unit
I_S	Continuous source current	Integral reverse p-n Junction diode in the MOSFET			10	A
I_{SM}	Pulsed source current				40	A
V_{SD}	Diode forward voltage drop.	$I_S=10A, V_{GS}=0V$			1.4	V
t_{rr}	Reverse recovery time	$I_S=10A, V_{GS}=0V,$		355		ns
Q_{rr}	Reverse recovery charge	$di_f/dt=100A/\mu s$		2.9		μC

※. Notes

1. Repeattive rating : pulse width limited by junction temperature.
2. $L = 8.1\text{mH}, I_{AS} = 10A, V_{DD} = 50V, R_G = 25\Omega$, Starting $T_J = 25^\circ\text{C}$
3. $I_{SD} \leq 10A, di/dt = 100A/\mu s, V_{DD} \leq BV_{DSS}$, Starting $T_J = 25^\circ\text{C}$
4. Pulse Test : Pulse Width $\leq 300\mu s$, duty cycle $\leq 2\%$.
5. Essentially independent of operating temperature.

Fig. 1. On-state characteristics

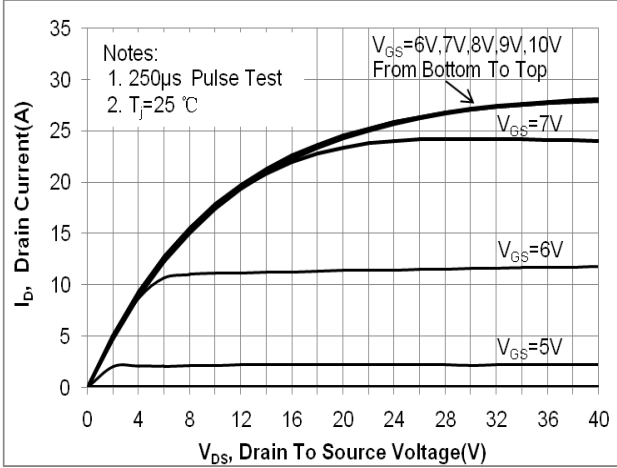

Fig. 2. Transfer Characteristics

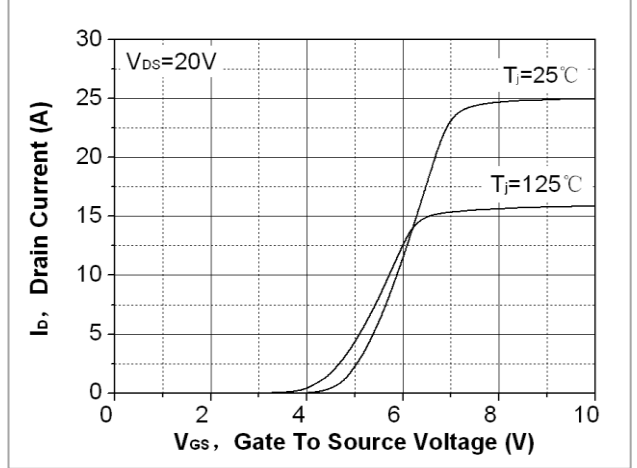

Fig. 3. On-resistance variation vs. drain current and gate voltage

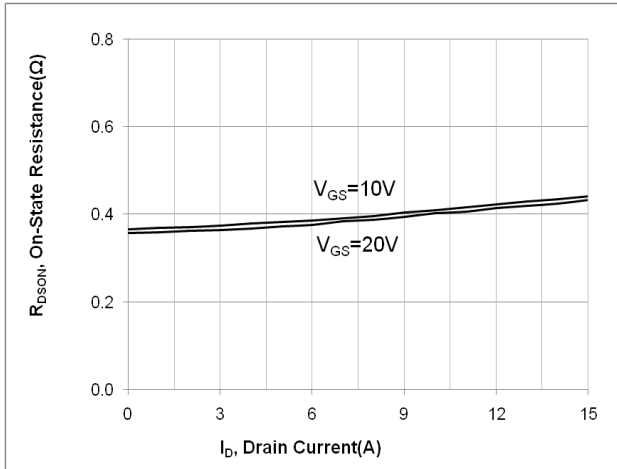

Fig. 4. On-state current vs. diode forward voltage

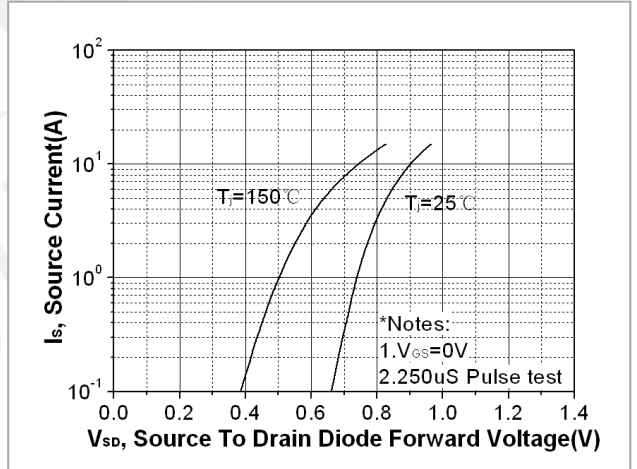

Fig 5. Breakdown voltage variation vs. junction temperature

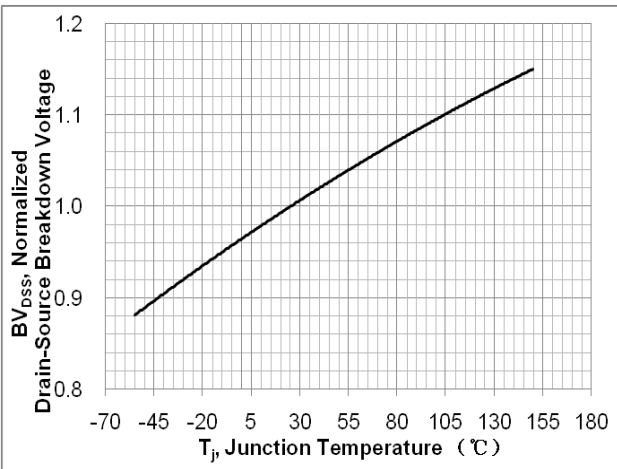

Fig. 6. On-resistance variation vs. junction temperature

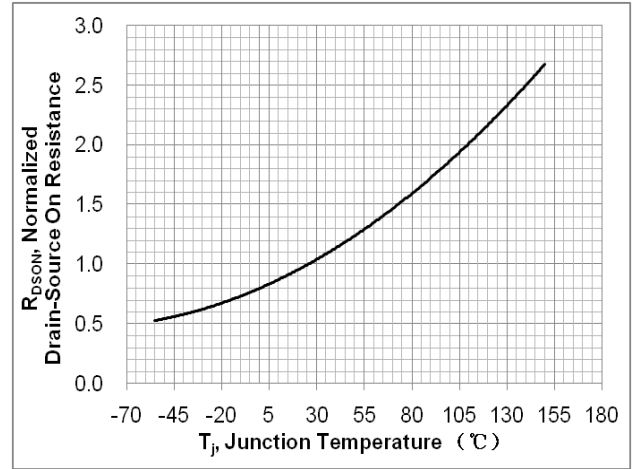

Fig. 7. Gate charge characteristics

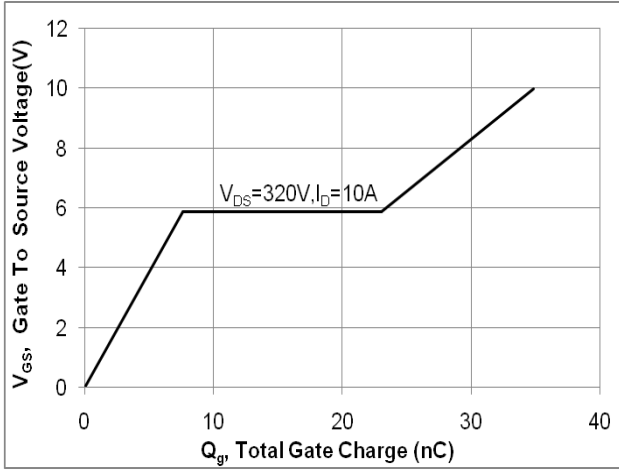

Fig. 8. Capacitance Characteristics

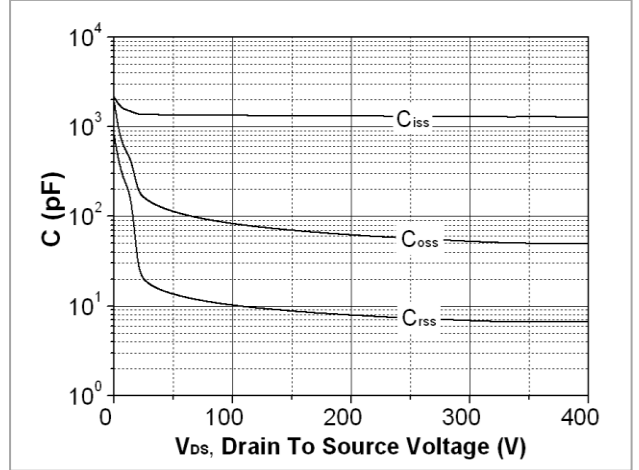

Fig. 9. Maximum safe operating area(TO-220)

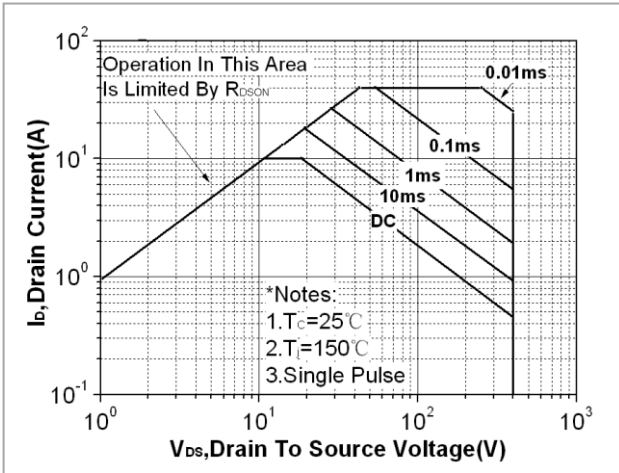

Fig. 10. Maximum safe operating area (TO-220F)

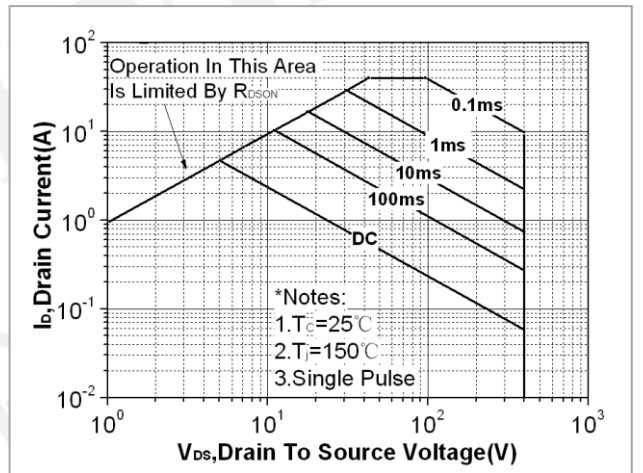

Fig. 11. Maximum safe operating area (TO-252)

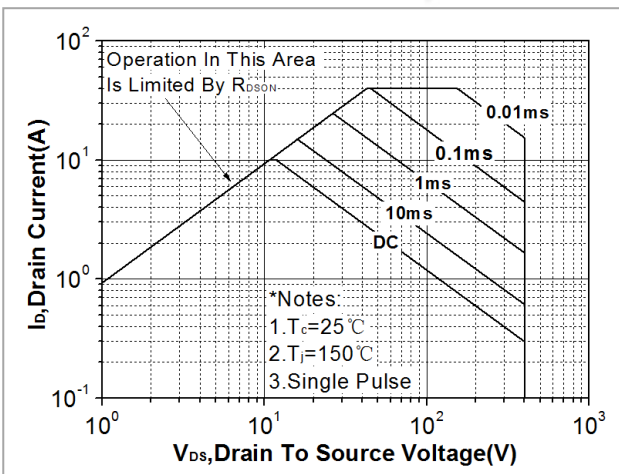

Fig. 12. Transient thermal response curve(TO-220)

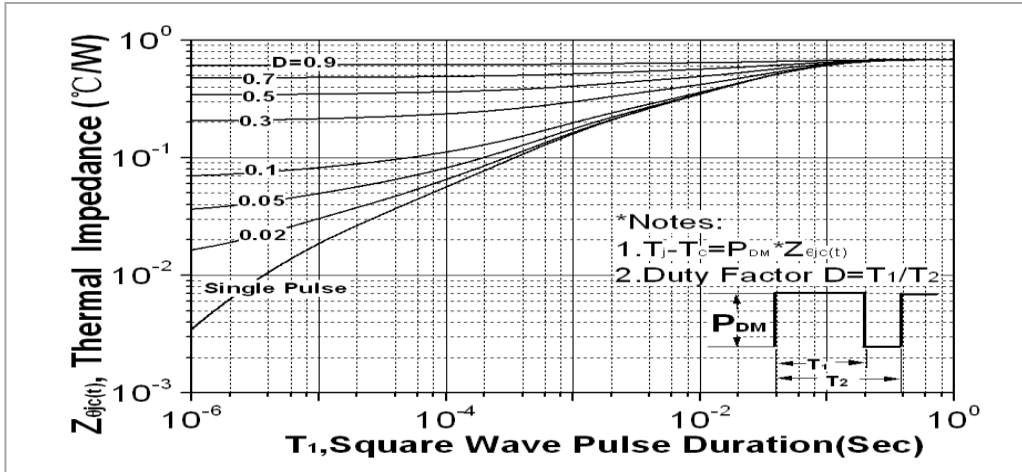

Fig. 13. Transient thermal response curve(TO-220F)

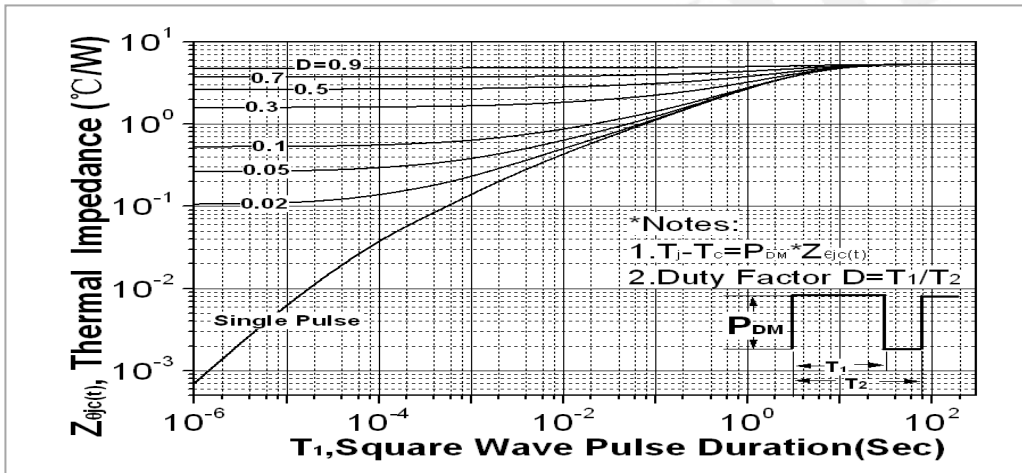

Fig. 14. Transient thermal response curve(TO-252)

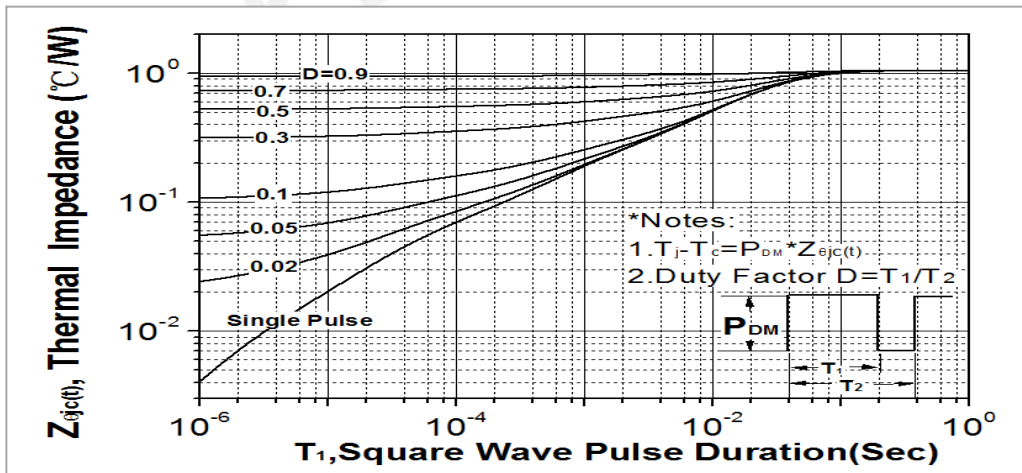

Fig. 15. Gate charge test circuit & waveform

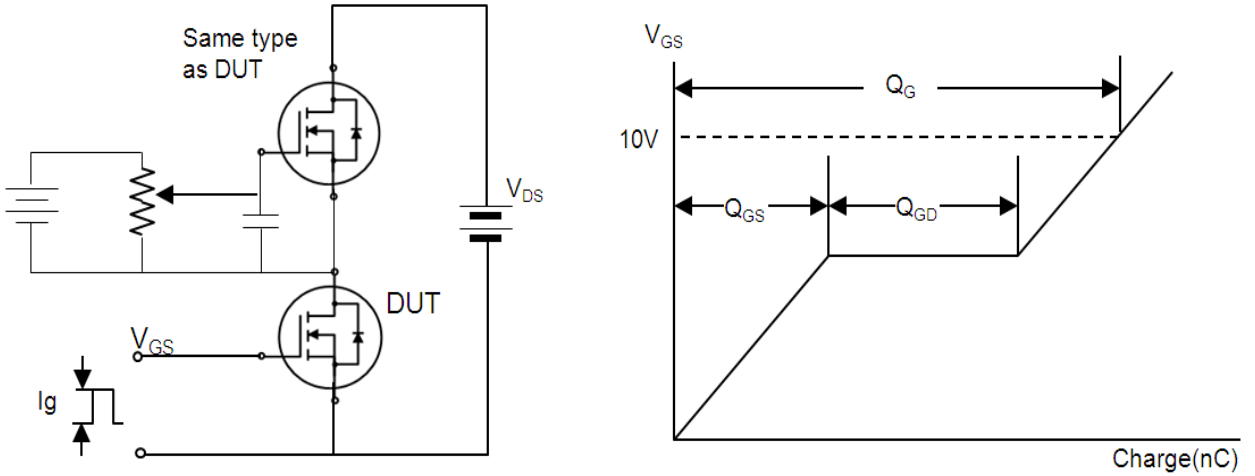

Fig. 16. Switching time test circuit & waveform

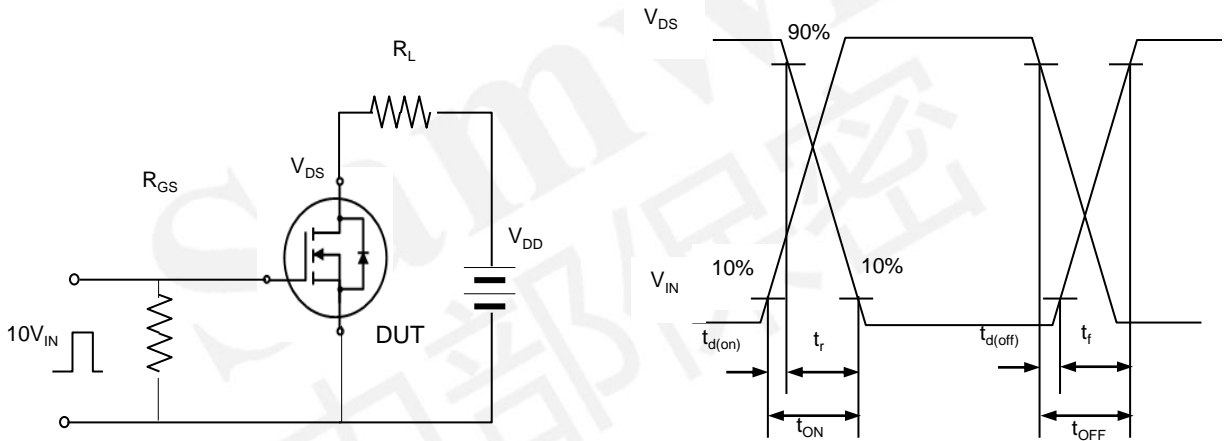

Fig. 17. Unclamped Inductive switching test circuit & waveform

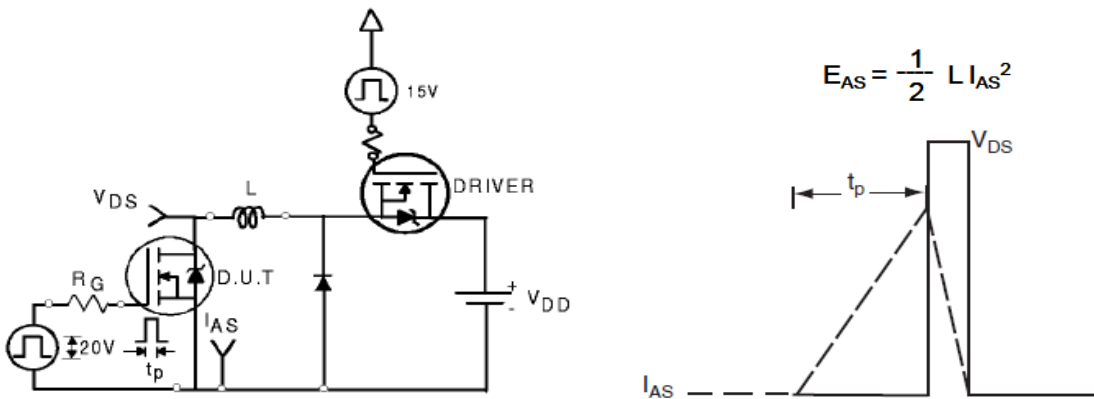
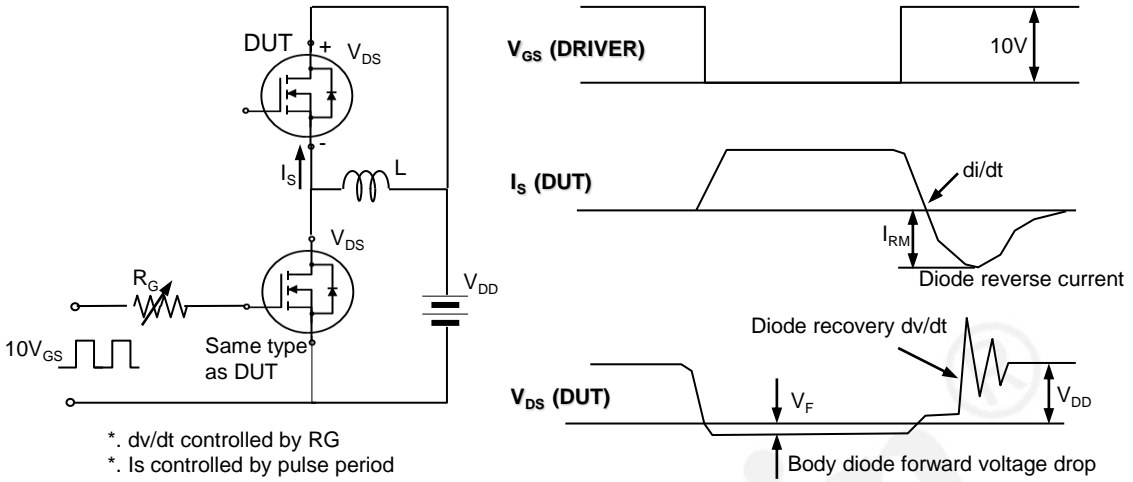



Fig. 18. Peak diode recovery dv/dt test circuit & waveform



DISCLAIMER

- * All the data & curve in this document was tested in SEMIPOWER TESTING & APPLICATION CENTER.
- * This product has passed the PCT,TC,HTRB,HTGB,HAST,PC and Solderdunk reliability testing.
- * Qualification standards can also be found on the Web site (<http://www.semipower.com.cn>) 
- * Suggestions for improvement are appreciated, Please send your suggestions to samwin@samwinsemi.com