

TLP291(SE

1. Applications

- Switching Power Supplies
- Programmable Logic Controllers (PLCs)
- I/O Interface Boards

2. General

TLP291(SE consists of photo transistor optically coupled to an infrared emitting diode.

TLP291(SE is housed in the SO4 package, very small and thin coupler.

Since TLP291(SE is guaranteed wide operating temperature ($T_a = -55$ to $110\text{ }^\circ\text{C}$) and high isolation voltage (3750 Vrms), it's suitable for high-density surface mounting applications such as small switching power supplies and programmable controllers.

3. Features

- (1) Collector-emitter voltage: 80 V (min)
- (2) Current transfer ratio: 50 % (min)
GB Rank: 100 % (min)
- (3) Isolation voltage: 3750 Vrms (min)
- (4) Operating temperature: -55 to $110\text{ }^\circ\text{C}$
- (5) Safety standards

UL-recognized: UL 1577, File No.E67349

cUL-recognized: CSA Component Acceptance Service No.5A File No.E67349

VDE-approved: EN 60747-5-5, EN 62368-1 (**Note 1**)

CQC-approved: GB4943.1, GB8898 Japan and Thailand Factory



仅适用于海拔 2000m 以下地区安全使用

Note 1: When a VDE approved type is needed, please designate the **Option (V4)**.

4. Packaging and Pin Assignment

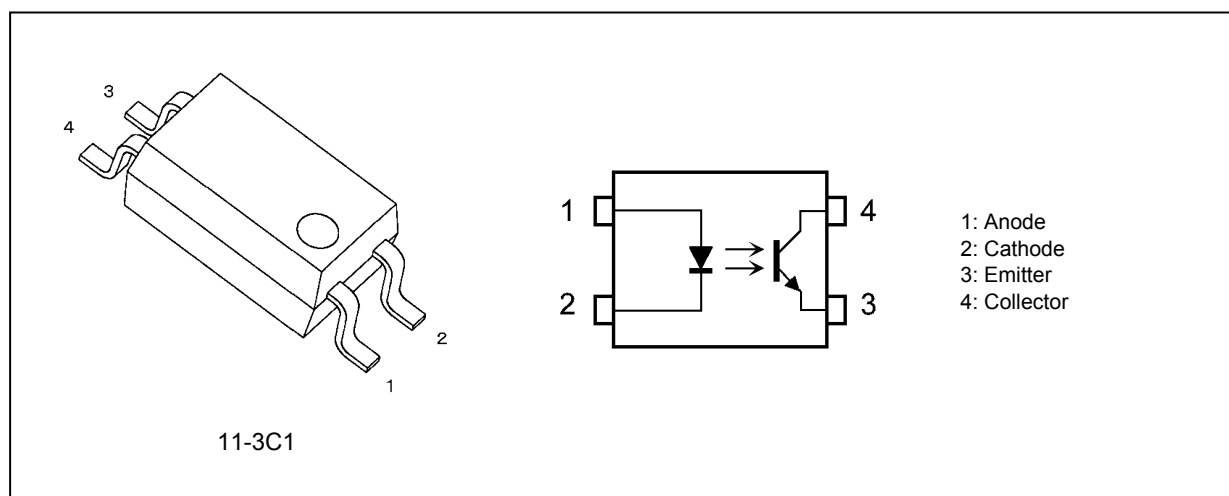

Start of commercial production

2012-02

5. Mechanical Parameters

| Characteristics | Min | Unit |
|------------------------------|-----|------|
| Creepage distances | 5.0 | mm |
| Clearance | 5.0 | |
| Internal isolation thickness | 0.4 | |

6. Absolute Maximum Ratings (Note) (Unless otherwise specified, $T_a = 25\text{ }^\circ\text{C}$)

| | Characteristics | Symbol | Note | Rating | Unit |
|----------|--|---------------------------|----------|------------|----------------------|
| LED | Input forward current | I_F | | 50 | mA |
| | Input forward current derating ($T_a \geq 90\text{ }^\circ\text{C}$) | $\Delta I_F / \Delta T_a$ | | -1.5 | mA/ $^\circ\text{C}$ |
| | Input forward current (pulsed) | I_{FP} | (Note 1) | 1 | A |
| | Input reverse voltage | V_R | | 5 | V |
| | Input power dissipation | P_D | | 100 | mW |
| | Input power dissipation derating ($T_a \geq 90\text{ }^\circ\text{C}$) | $\Delta P_D / \Delta T_a$ | | -3.0 | mW/ $^\circ\text{C}$ |
| | Junction temperature | T_j | | 125 | $^\circ\text{C}$ |
| Detector | Collector-emitter voltage | V_{CEO} | | 80 | V |
| | Emitter-collector voltage | V_{ECO} | | 7 | V |
| | Collector current | I_C | | 50 | mA |
| | Collector power dissipation | P_C | | 150 | mW |
| | Collector power dissipation derating ($T_a \geq 25\text{ }^\circ\text{C}$) | $\Delta P_C / \Delta T_a$ | | -1.5 | mW/ $^\circ\text{C}$ |
| | Junction temperature | T_j | | 125 | $^\circ\text{C}$ |
| Common | Operating temperature | T_{opr} | | -55 to 110 | $^\circ\text{C}$ |
| | Storage temperature | T_{stg} | | -55 to 125 | $^\circ\text{C}$ |
| | Lead soldering temperature (10 s) | T_{sol} | | 260 | $^\circ\text{C}$ |
| | Total power dissipation | P_T | | 200 | mW |
| | Total power dissipation derating ($T_a \geq 25\text{ }^\circ\text{C}$) | $\Delta P_T / \Delta T_a$ | | -2.0 | mW/ $^\circ\text{C}$ |
| | Isolation voltage AC, 60 s, R.H. $\leq 60\%$ | BV_S | (Note 2) | 3750 | Vrms |

Note: Using continuously under heavy loads (e.g. the application of high temperature/current/voltage and the significant change in temperature, etc.) may cause this product to decrease in the reliability significantly even if the operating conditions (i.e. operating temperature/current/voltage, etc.) are within the absolute maximum ratings.

Please design the appropriate reliability upon reviewing the Toshiba Semiconductor Reliability Handbook ("Handling Precautions"/"Derating Concept and Methods") and individual reliability data (i.e. reliability test report and estimated failure rate, etc).

Note 1: Pulse width (PW) ≤ 0.1 ms, $f = 100$ Hz

Note 2: This device is considered as a two-terminal device: Pins 1 and 2 are shorted together, and pins 3 and 4 are shorted together.

7. Electrical Characteristics (Unless otherwise specified, $T_a = 25\text{ }^\circ\text{C}$)

| | Characteristics | Symbol | Note | Test Condition | Min | Typ. | Max | Unit |
|-------------------------------|-------------------------------------|---------------|------|---|-----|-------|------|---------------|
| LED | Input forward voltage | V_F | | $I_F = 10$ mA | 1.1 | 1.25 | 1.4 | V |
| | Input reverse current | I_R | | $V_R = 5$ V | — | — | 5 | μA |
| | Input capacitance | C_t | | $V = 0$ V, $f = 1$ MHz | — | 30 | — | pF |
| Detector | Collector-emitter breakdown voltage | $V_{(BR)CEO}$ | | $I_C = 0.5$ mA | 80 | — | — | V |
| | Emitter-collector breakdown voltage | $V_{(BR)ECO}$ | | $I_E = 0.1$ mA | 7 | — | — | V |
| | Dark Current | I_{DARK} | | $V_{CE} = 48$ V | — | 0.001 | 0.08 | μA |
| | | | | $V_{CE} = 48$ V, $T_a = 85\text{ }^\circ\text{C}$ | — | 2 | 50 | |
| Collector-emitter capacitance | C_{CE} | | | $V = 0$ V, $f = 1$ MHz | — | 10 | — | pF |

8. Coupled Electrical Characteristics (Unless otherwise specified, $T_a = 25\text{ }^\circ\text{C}$)

| Characteristics | Symbol | Note | Test Condition | Min | Typ. | Max | Unit |
|--------------------------------------|-------------------------|----------|--|-----|------|-----|---------------|
| Current transfer ratio | I_C/I_F | (Note 1) | $I_F = 5\text{ mA}, V_{CE} = 5\text{ V}$ | 50 | — | 600 | % |
| | | | $I_F = 5\text{ mA}, V_{CE} = 5\text{ V}, \text{Rank GB}$ | 100 | — | 600 | |
| Saturated current transfer ratio | $I_C/I_{F(\text{sat})}$ | | $I_F = 1\text{ mA}, V_{CE} = 0.4\text{ V}$ | — | 60 | — | |
| | | | $I_F = 1\text{ mA}, V_{CE} = 0.4\text{ V}, \text{Rank GB}$ | 30 | — | — | |
| Collector-emitter saturation voltage | $V_{CE(\text{sat})}$ | | $I_C = 2.4\text{ mA}, I_F = 8\text{ mA}$ | — | — | 0.3 | V |
| | | | $I_C = 0.2\text{ mA}, I_F = 1\text{ mA}$ | — | 0.12 | — | |
| | $V_{CE(\text{sat})}$ | | $I_C = 0.2\text{ mA}, I_F = 1\text{ mA}, \text{Rank GB}$ | — | — | 0.3 | |
| OFF-state collector current | $I_{C(\text{off})}$ | | $V_F = 0.7\text{ V}, V_{CE} = 48\text{ V}$ | — | — | 10 | μA |

Note 1: See Table 8.1 for current transfer ratio.

Table 8.1 Current Transfer Ratio (CTR) Rank (Note) (Unless otherwise specified, $T_a = 25\text{ }^\circ\text{C}$)

| Rank | Rank short code | Note | Test Condition | Current transfer ratio I_C/I_F (min) | Current transfer ratio I_C/I_F (max) | Marking of classification | Unit |
|-------|-----------------|----------|--|--|--|-------------------------------------|------|
| Blank | — | | $I_F = 5\text{ mA}, V_{CE} = 5\text{ V}$ | 50 | 600 | Blank, YE, GR, GB, BL, Y+, G, G+, B | % |
| Y | — | | $I_F = 5\text{ mA}, V_{CE} = 5\text{ V}$ | 50 | 150 | YE, Y+ | |
| GR | — | | $I_F = 5\text{ mA}, V_{CE} = 5\text{ V}$ | 100 | 300 | GR, G, G+ | |
| GB | — | | $I_F = 5\text{ mA}, V_{CE} = 5\text{ V}$ | 100 | 600 | GB, GR, G, G+, BL, B | |
| BL | — | | $I_F = 5\text{ mA}, V_{CE} = 5\text{ V}$ | 200 | 600 | BL, B | |
| YH | — | | $I_F = 5\text{ mA}, V_{CE} = 5\text{ V}$ | 75 | 150 | Y+ | |
| GRL | GL | (Note 1) | $I_F = 5\text{ mA}, V_{CE} = 5\text{ V}$ | 100 | 200 | G | |
| GRH | GH | (Note 1) | $I_F = 5\text{ mA}, V_{CE} = 5\text{ V}$ | 150 | 300 | G+ | |
| BLL | B | (Note 1) | $I_F = 5\text{ mA}, V_{CE} = 5\text{ V}$ | 200 | 400 | B | |

Note: Specify both the part number and a rank in this format when ordering.

Example: TLP291(GB,SE)

For safety standard certification, however, specify the part number alone.

Example: TLP291(GB,SE → TLP291

Note 1: A rank in the order name is sometimes omitted like above "Rank short code".

9. Isolation Characteristics (Unless otherwise specified, $T_a = 25\text{ }^\circ\text{C}$)

| Characteristics | Symbol | Note | Test Condition | Min | Typ. | Max | Unit |
|-------------------------------------|--------|----------|---|--------------------|-----------|-----|---------------|
| Total capacitance (input to output) | C_S | (Note 1) | $V_S = 0\text{ V}, f = 1\text{ MHz}$ | — | 0.8 | — | μF |
| Isolation resistance | R_S | (Note 1) | $V_S = 500\text{ V}, \text{R.H.} \leq 60\%$ | 1×10^{12} | 10^{14} | — | Ω |
| Isolation voltage | BV_S | (Note 1) | AC, 60 s | 3750 | — | — | Vrms |

Note 1: This device is considered as a two-terminal device: Pins 1 and 2 are shorted together, and pins 3 and 4 are shorted together.

10. Switching Characteristics (Unless otherwise specified, $T_a = 25\text{ }^\circ\text{C}$)

| Characteristics | Symbol | Note | Test Condition | Min | Typ. | Max | Unit |
|-----------------|-----------|------|---|-----|------|-----|---------------|
| Rise time | t_r | | $V_{CC} = 10\text{ V}$, $I_C = 2\text{ mA}$, $R_L = 100\ \Omega$ | — | 2 | — | μs |
| Fall time | t_f | | | — | 3 | — | |
| Turn-on time | t_{on} | | | — | 3 | — | |
| Turn-off time | t_{off} | | | — | 3 | — | |
| Turn-on time | t_{on} | | See Fig. 10.1 $R_L = 1.9\text{ k}\Omega$, $V_{CC} = 5\text{ V}$, $I_F = 16\text{ mA}$ | — | 0.5 | — | |
| Storage time | t_s | | | — | 25 | — | |
| Turn-off time | t_{off} | | | — | 40 | — | |



Fig. 10.1 Switching Time Test Circuit and Waveform

11. Characteristics Curves (Note)

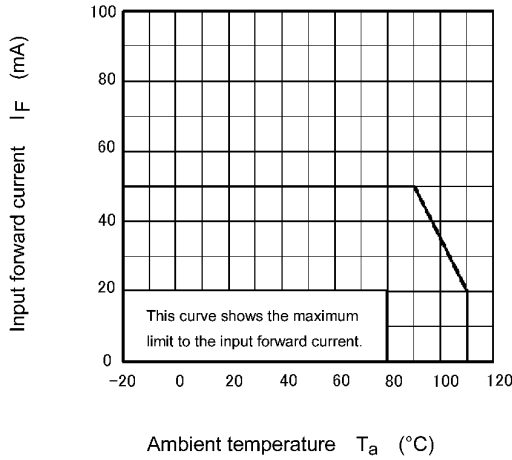

Fig. 11.1 $I_F - T_a$

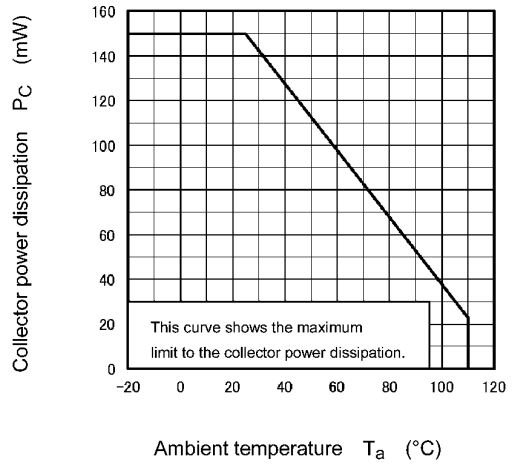

Fig. 11.2 $P_C - T_a$

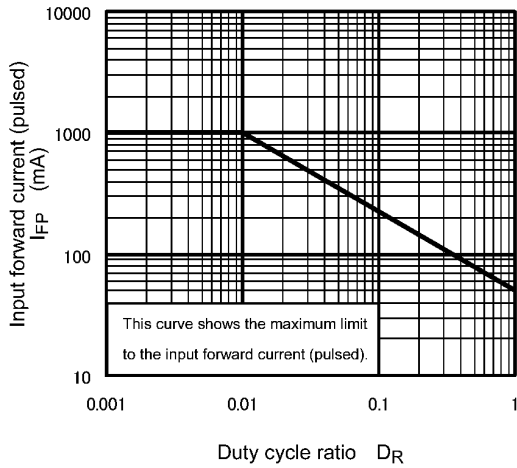

Fig. 11.3 $I_{FP} - D_R$

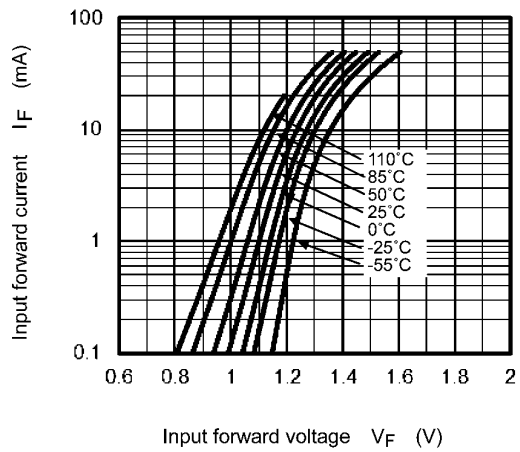

Fig. 11.4 $I_F - V_F$

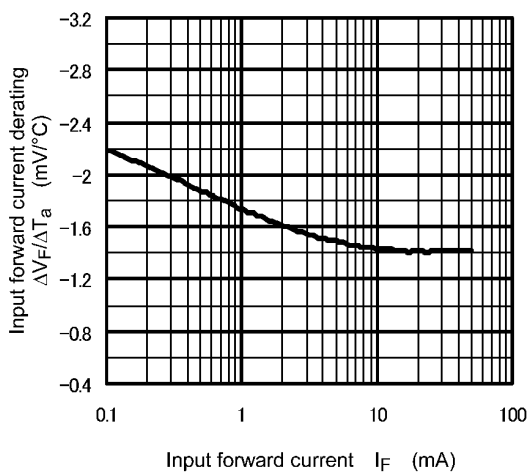

Fig. 11.5 $\Delta V_F/\Delta T_a - I_F$

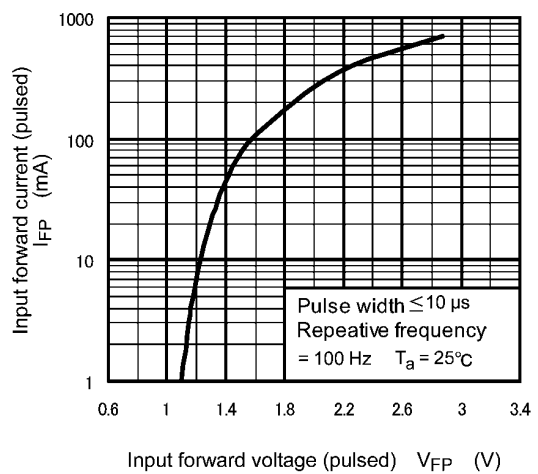

Fig. 11.6 $I_{FP} - V_{FP}$

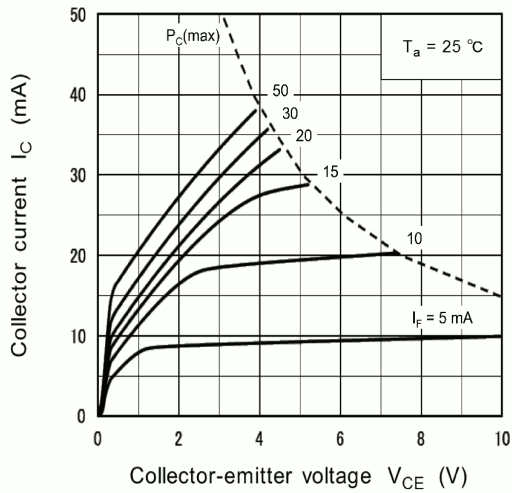

Fig. 11.7 $I_C - V_{CE}$

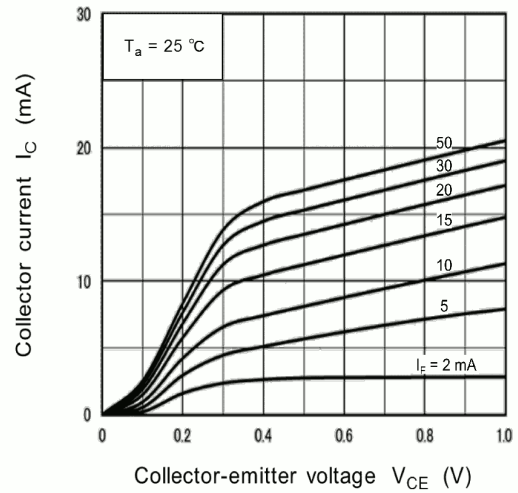

Fig. 11.8 $I_C - V_{CE}$

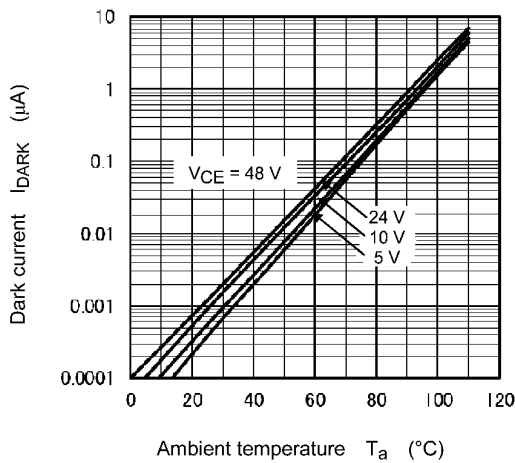

Fig. 11.9 $I_{DARK} - T_a$

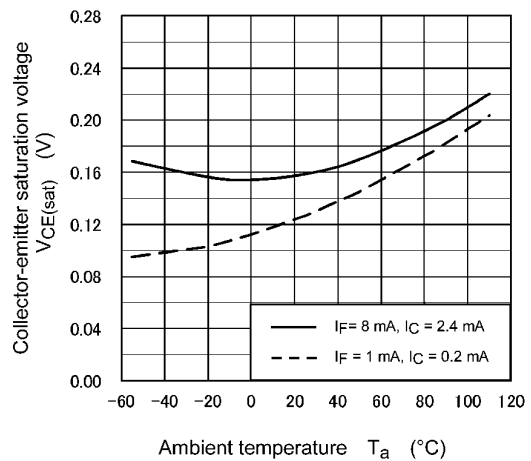

Fig. 11.10 $V_{CE(sat)} - T_a$

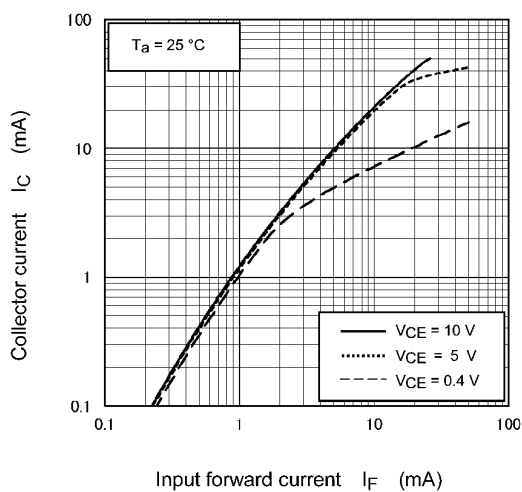

Fig. 11.11 $I_C - I_F$

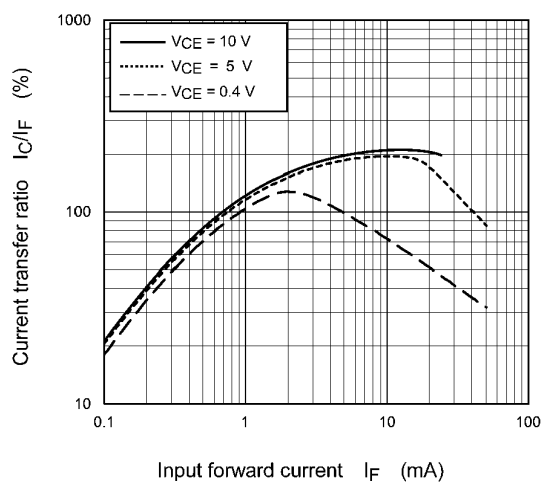

Fig. 11.12 $I_C/I_F - I_F$



Fig. 11.13 $I_C - T_a$

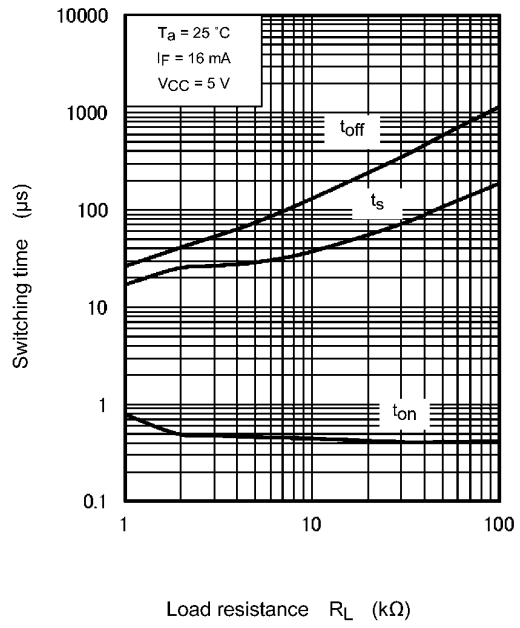

Fig. 11.14 Switching Time - R_L

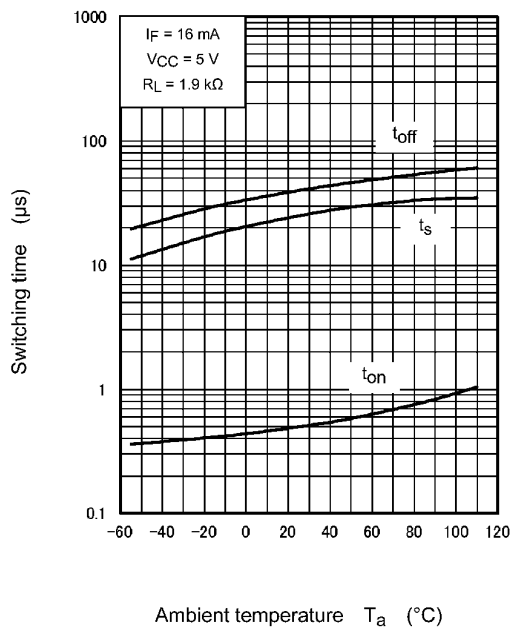

Fig. 11.15 Switching Time - T_a

Note: The above characteristics curves are presented for reference only and not guaranteed by production test, unless otherwise noted.

12. Soldering and Storage

12.1. Precautions for Soldering

The soldering temperature should be controlled as closely as possible to the conditions shown below, irrespective of whether a soldering iron or a reflow soldering method is used.

- When using soldering reflow.

The soldering temperature profile is based on the package surface temperature.

(See the figure shown below, which is based on the package surface temperature.)

Reflow soldering must be performed once or twice.

The mounting should be completed with the interval from the first to the last mountings being 2 weeks.

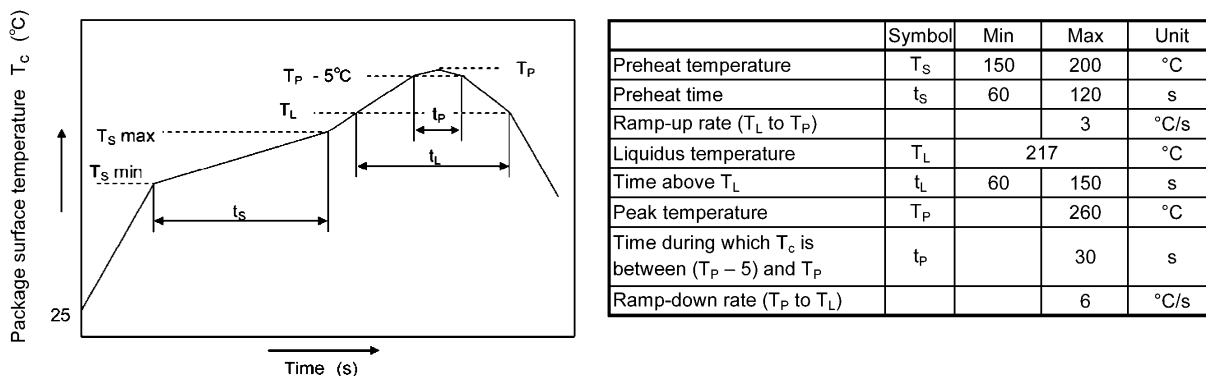

Fig. 12.1.1 An Example of a Temperature Profile When Lead(Pb)-Free Solder Is Used

- When using soldering flow
Preheat the device at a temperature of 150 °C (package surface temperature) for 60 to 120 seconds.
Mounting condition of 260 °C within 10 seconds is recommended.
Flow soldering must be performed once.
- When using soldering Iron
Complete soldering within 10 seconds for lead temperature not exceeding 260 °C or within 3 seconds not exceeding 350 °C
Heating by soldering iron must be done only once per lead.

12.2. Precautions for General Storage

- Avoid storage locations where devices may be exposed to moisture or direct sunlight.
- Follow the precautions printed on the packing label of the device for transportation and storage.
- Keep the storage location temperature and humidity within a range of 5 °C to 35 °C and 45 % to 75 %, respectively.
- Do not store the products in locations with poisonous gases (especially corrosive gases) or in dusty conditions.
- Store the products in locations with minimal temperature fluctuations. Rapid temperature changes during storage can cause condensation, resulting in lead oxidation or corrosion, which will deteriorate the solderability of the leads.
- When restoring devices after removal from their packing, use anti-static containers.
- Do not allow loads to be applied directly to devices while they are in storage.
- If devices have been stored for more than two years under normal storage conditions, it is recommended that you check the leads for ease of soldering prior to use.

13. Land Pattern Dimensions (for reference only)

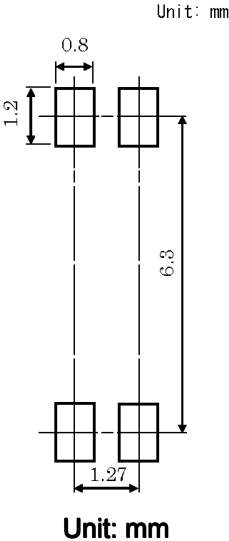

14. Marking

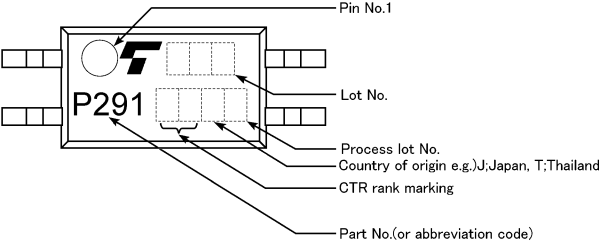

15. EN 60747-5-5 Option (V4) Specification

- Part number: TLP291 (**Note 1**)
- The following part naming conventions are used for the devices that have been qualified according to option (V4) of EN 60747.

Example: TLP291(V4GBTL,SE)

V4: EN 60747 option

GB: CTR rank

TL: Tape type (L direction:TPL)

E: [[G]]/RoHS COMPATIBLE (**Note 2**)

Note 1: Use TOSHIBA standard type number for safety standard application.

e.g., TLP291(V4GBTL,SE → TLP291

Note 2: Please contact your Toshiba sales representative for details on environmental information such as the product's RoHS compatibility.

RoHS is the Directive 2011/65/EU of the European Parliament and of the Council of 8 June 2011 on the restriction of the use of certain hazardous substances in electrical and electronic equipment.

| Description | Symbol | Rating | Unit |
|--|-------------------------------|---|----------------|
| Application classification for rated mains voltage ≤ 150 Vrms for rated mains voltage ≤ 300 Vrms | | I-IV I-III | — |
| Climatic classification | | 55 / 125 / 21 | — |
| Pollution degree | | 2 | — |
| Maximum operating insulation voltage | VIORM | 707 | Vpeak |
| Input to output test voltage, Method A $V_{pr} = 1.6 \times VIORM$, type and sample test $t_p = 10$ s, partial discharge < 5 pC | V_{pr} | 1131 | Vpeak |
| Input to output test voltage, Method B $V_{pr} = 1.875 \times VIORM$, 100 % production test $t_p = 1$ s, partial discharge < 5 pC | V_{pr} | 1330 | Vpeak |
| Highest permissible overvoltage (transient overvoltage, $t_{pr} = 60$ s) | VTR | 6000 | Vpeak |
| Safety limiting values (max. permissible ratings in case of fault, also refer to thermal derating curve) current (input current I_F , $P_{SO} = 0$) power (output or total power dissipation) temperature | I_{si} P_{SO} T_s | 250 400 150 | mA mW °C |
| Insulation resistance $V_{IO} = 500$ V, $T_a = 25$ °C $V_{IO} = 500$ V, $T_a = 100$ °C $V_{IO} = 500$ V, $T_a = T_s$ | R_{si} | $\geq 10^{12}$ $\geq 10^{11}$ $\geq 10^9$ | Ω |

Fig. 15.1 EN 60747 Insulation Characteristics

Table Insulation Related Specifications (Note)

| Insulation Related Parameters | Symbol | TLP291 |
|-------------------------------|--------|--------|
| Minimum creepage distance | Cr | 5.0 mm |
| Minimum clearance | Cl | 5.0 mm |
| Minimum insulation thickness | ti | 0.4 mm |
| Comparative tracking index | CTI | 175 |

Note: This photocoupler is suitable for **safe electrical isolation** only within the safety limit data. Maintenance of the safety data shall be ensured by means of protective circuits.



Fig. 15.2 Marking on packing for EN 60747

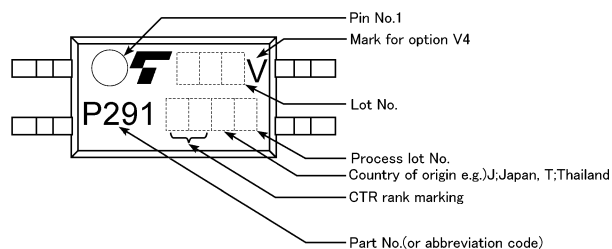

Fig. 15.3 Marking Example (Note)

Note: The above marking is applied to the photocouplers that have been qualified according to option (V4) of EN 60747.

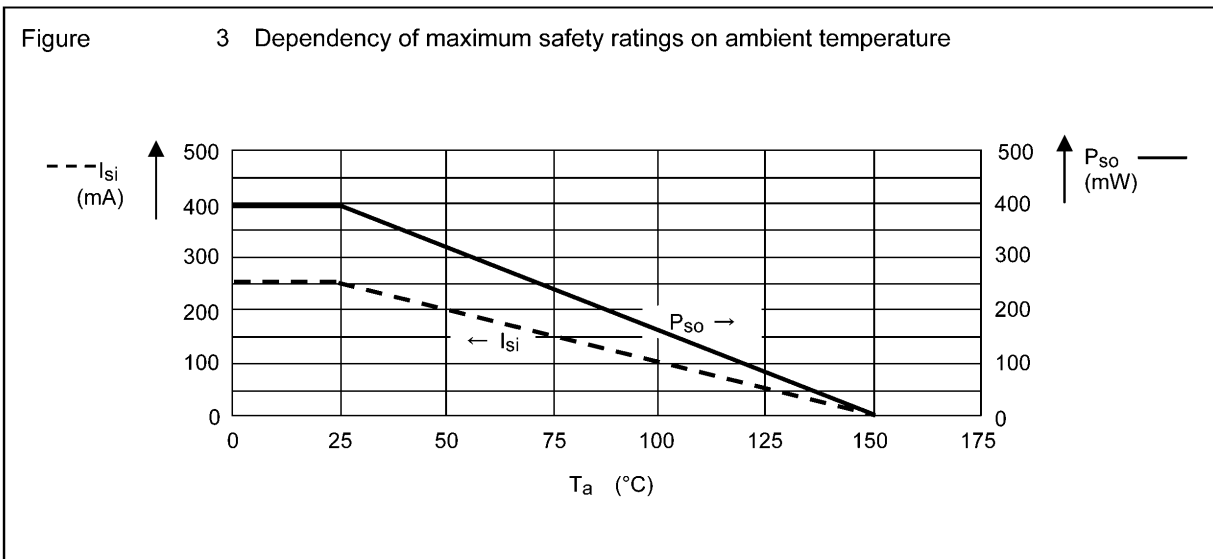
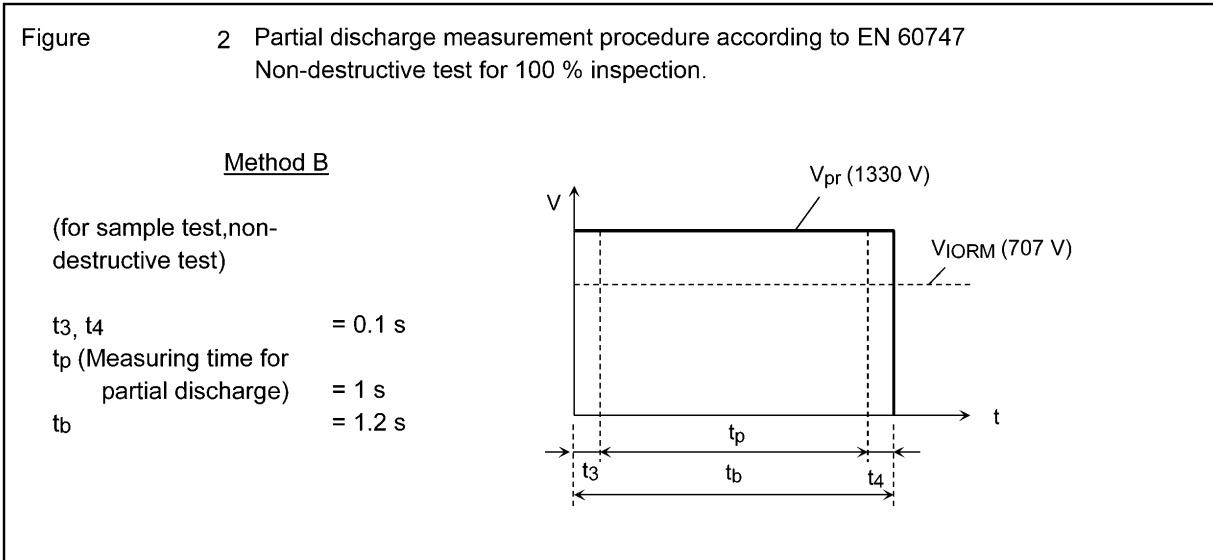
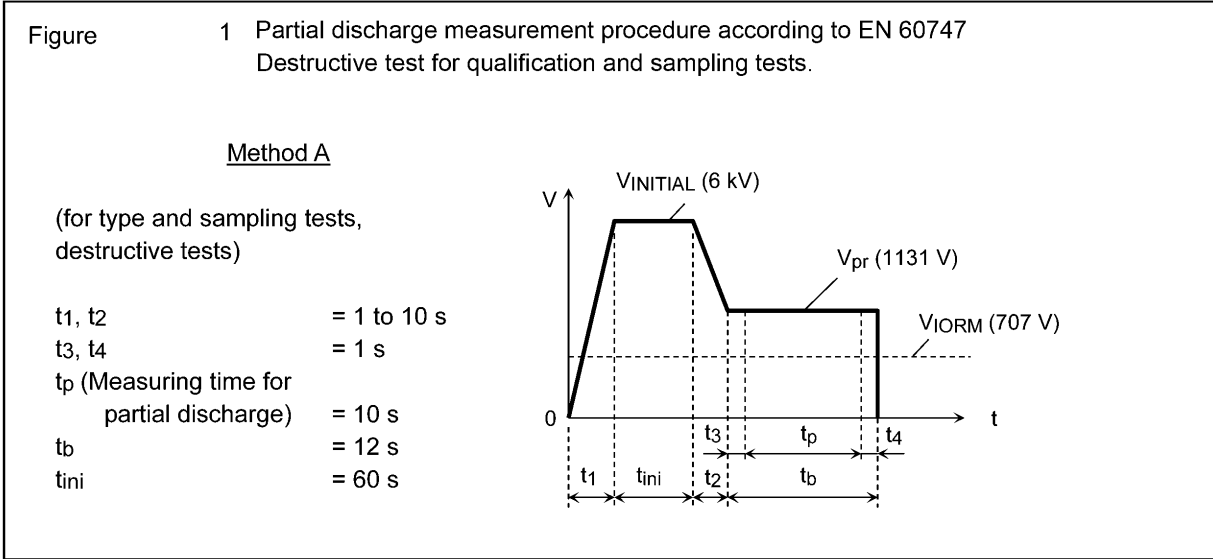

Fig. 15.4 Measurement Procedure

15.1. Ordering Information

When placing an order, please specify the part number, CTR rank, tape type and quantity as shown in the following example.

Example) TLP291(GB-TP,SE 5000 pcs

Part number: TLP291

CTR rank: GB

Tape type: TP (L direction)

[[G]]/RoHS COMPATIBLE: E (**Note 1**)

Quantity (must be a multiple of 2500): 5000 pcs

Note 1: Please contact your Toshiba sales representative for details on environmental information such as the product's RoHS compatibility.

RoHS is the Directive 2011/65/EU of the European Parliament and of the Council of 8 June 2011 on the restriction of the use of certain hazardous substances in electrical and electronic equipment.

Package Dimensions

Unit: mm

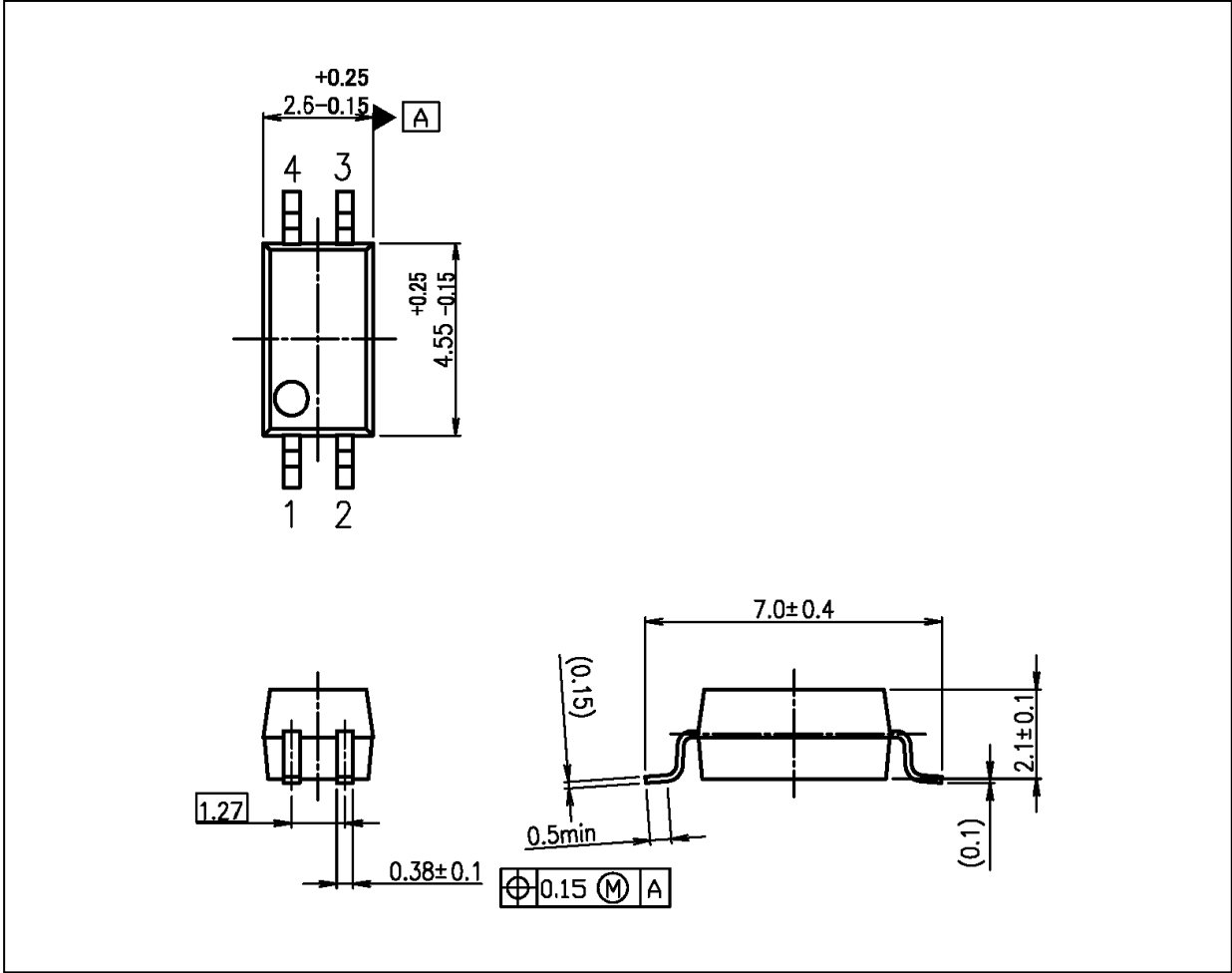

Weight: 0.05 g (typ.)

| Package Name(s) |
|-----------------|
| TOSHIBA: 11-3C1 |

RESTRICTIONS ON PRODUCT USE

Toshiba Corporation and its subsidiaries and affiliates are collectively referred to as "TOSHIBA".

Hardware, software and systems described in this document are collectively referred to as "Product".

- TOSHIBA reserves the right to make changes to the information in this document and related Product without notice.
- This document and any information herein may not be reproduced without prior written permission from TOSHIBA. Even with TOSHIBA's written permission, reproduction is permissible only if reproduction is without alteration/omission.
- Though TOSHIBA works continually to improve Product's quality and reliability, Product can malfunction or fail. Customers are responsible for complying with safety standards and for providing adequate designs and safeguards for their hardware, software and systems which minimize risk and avoid situations in which a malfunction or failure of Product could cause loss of human life, bodily injury or damage to property, including data loss or corruption. Before customers use the Product, create designs including the Product, or incorporate the Product into their own applications, customers must also refer to and comply with (a) the latest versions of all relevant TOSHIBA information, including without limitation, this document, the specifications, the data sheets and application notes for Product and the precautions and conditions set forth in the "TOSHIBA Semiconductor Reliability Handbook" and (b) the instructions for the application with which the Product will be used with or for. Customers are solely responsible for all aspects of their own product design or applications, including but not limited to (a) determining the appropriateness of the use of this Product in such design or applications; (b) evaluating and determining the applicability of any information contained in this document, or in charts, diagrams, programs, algorithms, sample application circuits, or any other referenced documents; and (c) validating all operating parameters for such designs and applications.
TOSHIBA ASSUMES NO LIABILITY FOR CUSTOMERS' PRODUCT DESIGN OR APPLICATIONS.

- **PRODUCT IS NEITHER INTENDED NOR WARRANTED FOR USE IN EQUIPMENTS OR SYSTEMS THAT REQUIRE EXTRAORDINARILY HIGH LEVELS OF QUALITY AND/OR RELIABILITY, AND/OR A MALFUNCTION OR FAILURE OF WHICH MAY CAUSE LOSS OF HUMAN LIFE, BODILY INJURY, SERIOUS PROPERTY DAMAGE AND/OR SERIOUS PUBLIC IMPACT ("UNINTENDED USE").**

Except for specific applications as expressly stated in this document, Unintended Use includes, without limitation, equipment used in nuclear facilities, equipment used in the aerospace industry, lifesaving and/or life supporting medical equipment, equipment used for automobiles, trains, ships and other transportation, traffic signaling equipment, equipment used to control combustions or explosions, safety devices, elevators and escalators, and devices related to power plant.

IF YOU USE PRODUCT FOR UNINTENDED USE, TOSHIBA ASSUMES NO LIABILITY FOR PRODUCT.

For details, please contact your TOSHIBA sales representative or contact us via our website.

- Do not disassemble, analyze, reverse-engineer, alter, modify, translate or copy Product, whether in whole or in part.
- Product shall not be used for or incorporated into any products or systems whose manufacture, use, or sale is prohibited under any applicable laws or regulations.
- The information contained herein is presented only as guidance for Product use. No responsibility is assumed by TOSHIBA for any infringement of patents or any other intellectual property rights of third parties that may result from the use of Product. No license to any intellectual property right is granted by this document, whether express or implied, by estoppel or otherwise.
- **ABSENT A WRITTEN SIGNED AGREEMENT, EXCEPT AS PROVIDED IN THE RELEVANT TERMS AND CONDITIONS OF SALE FOR PRODUCT, AND TO THE MAXIMUM EXTENT ALLOWABLE BY LAW, TOSHIBA (1) ASSUMES NO LIABILITY WHATSOEVER, INCLUDING WITHOUT LIMITATION, INDIRECT, CONSEQUENTIAL, SPECIAL, OR INCIDENTAL DAMAGES OR LOSS, INCLUDING WITHOUT LIMITATION, LOSS OF PROFITS, LOSS OF OPPORTUNITIES, BUSINESS INTERRUPTION AND LOSS OF DATA, AND (2) DISCLAIMS ANY AND ALL EXPRESS OR IMPLIED WARRANTIES AND CONDITIONS RELATED TO SALE, USE OF PRODUCT, OR INFORMATION, INCLUDING WARRANTIES OR CONDITIONS OF MERCHANTABILITY, FITNESS FOR A PARTICULAR PURPOSE, ACCURACY OF INFORMATION, OR NONINFRINGEMENT.**
- GaAs (Gallium Arsenide) is used in Product. GaAs is harmful to humans if consumed or absorbed, whether in the form of dust or vapor. Handle with care and do not break, cut, crush, grind, dissolve chemically or otherwise expose GaAs in Product.
- Do not use or otherwise make available Product or related software or technology for any military purposes, including without limitation, for the design, development, use, stockpiling or manufacturing of nuclear, chemical, or biological weapons or missile technology products (mass destruction weapons). Product and related software and technology may be controlled under the applicable export laws and regulations including, without limitation, the Japanese Foreign Exchange and Foreign Trade Law and the U.S. Export Administration Regulations. Export and re-export of Product or related software or technology are strictly prohibited except in compliance with all applicable export laws and regulations.
- Please contact your TOSHIBA sales representative for details as to environmental matters such as the RoHS compatibility of Product. Please use Product in compliance with all applicable laws and regulations that regulate the inclusion or use of controlled substances, including without limitation, the EU RoHS Directive. **TOSHIBA ASSUMES NO LIABILITY FOR DAMAGES OR LOSSES OCCURRING AS A RESULT OF NONCOMPLIANCE WITH APPLICABLE LAWS AND REGULATIONS.**