



MD7208 series is a high voltage (up to 18V) ultra-low quiescent current low dropout voltage regulator (LDO) manufactured in CMOS processes. It can deliver up to 500mA of current while consuming only 1.6uA of quiescent current. It consists of a reference voltage generator, an error amplifier, a current foldback circuit, and a phase compensation circuit plus a driver transistor. The MD7208 series is designed specifically for applications where very-low I_Q is a critical

parameter. This device maintains low quiescent current consumption even in dropout mode to further increase the battery life.

■ Features:

- Ultra-low Quiescent Current: 1.6uA
- Maximum Input Voltage: 18V
- Output Voltage Highly Accurate: $\pm 2\%$
- Maximum Output Current: 500mA
- Dropout Voltage: 0.5V@ $I_{OUT}=500mA$
- Temperature Stability: $\pm 50ppm/^{\circ}C$
- ON/OFF Logic = Enable High
- Protections Circuits: Current Limiter, Foldback, Thermal shutdown
- Output Capacitor: Low ESR Ceramic Capacitor Compatible

■ Applications:

- Smart wearer
- Long-life battery-powered devices
- Portable mobile devices, such as mobile phones, cameras, and so on
- Wireless communication equipment

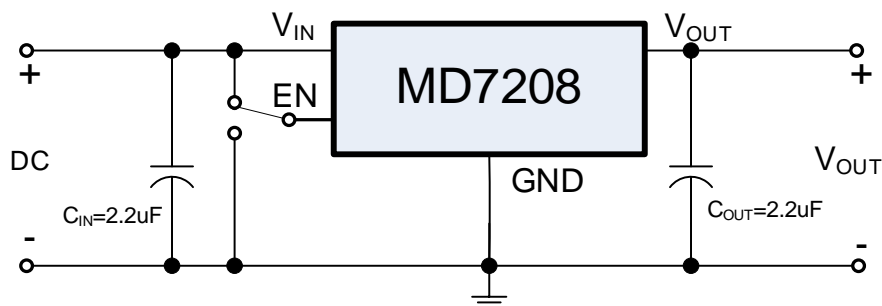
■ Typical Application:

■ Pin Configuration (Top View):

SOT89-3L(A_Type)
Top View

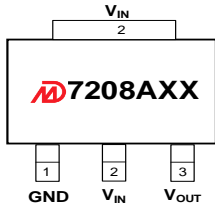

SOT89-3L(E_Type)
Top View

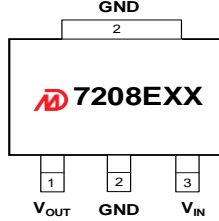

SOT89-5L
Top View

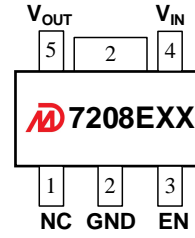

SOT223-3L(F_Type)
Top View

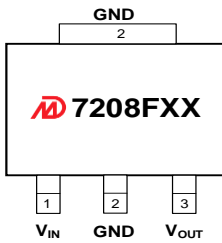

SOT23-5L
Top View





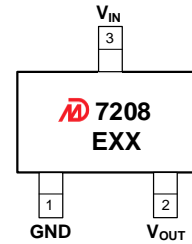











































SOT23-3L
Top View







■ Product Selections

Product Name	V _{OUT} (V)	Package	Ordering Name	Marking	Package Information
MD7208A12	1.2	SOT89-3L	MD7208A12PA1		Tape and Reel, 1000pcs
MD7208A15	1.5	SOT89-3L	MD7208A15PA1		
MD7208A18	1.8	SOT89-3L	MD7208A18PA1		
MD7208A21	2.1	SOT89-3L	MD7208A21PA1		
MD7208A25	2.5	SOT89-3L	MD7208A25PA1		
MD7208A27	2.7	SOT89-3L	MD7208A27PA1		
MD7208A28	2.8	SOT89-3L	MD7208A28PA1		
MD7208A30	3.0	SOT89-3L	MD7208A30PA1		
MD7208A33	3.3	SOT89-3L	MD7208A33PA1		
MD7208A36	3.6	SOT89-3L	MD7208A36PA1		
MD7208A38	3.8	SOT89-3L	MD7208A38PA1		
MD7208A40	4.0	SOT89-3L	MD7208A40PA1		
MD7208A50	5.0	SOT89-3L	MD7208A50PA1		
MD7208AC0	12.0	SOT89-3L	MD7208AC0PA1		
MD7208E12	1.2	SOT89-3L	MD7208E12PA1		
MD7208E15	1.5	SOT89-3L	MD7208E15PA1		
MD7208E18	1.8	SOT89-3L	MD7208E18PA1		
MD7208E21	2.1	SOT89-3L	MD7208E21PA1		
MD7208E25	2.5	SOT89-3L	MD7208E25PA1		
MD7208E27	2.7	SOT89-3L	MD7208E27PA1		
MD7208E28	2.8	SOT89-3L	MD7208E28PA1		
MD7208E30	3.0	SOT89-3L	MD7208E30PA1		
MD7208E33	3.3	SOT89-3L	MD7208E33PA1		

MD7208 Series
High Voltage Low Power Consumption LDO

MD7208E36	3.6	SOT89-3L	MD7208E36PA1	 7208E36	
MD7208E38	3.8	SOT89-3L	MD7208E38PA1	 7208E38	
MD7208E40	4.0	SOT89-3L	MD7208E40PA1	 7208E40	
MD7208E50	5.0	SOT89-3L	MD7208E50PA1	 7208E50	
MD7208EC0	12.0	SOT89-3L	MD7208EC0PA1	 7208EC0	
MD7208E12	1.2	SOT89-5L	MD7208E12PA1	 7208E12	Tape and Reel, 1000pcs
MD7208E15	1.5	SOT89-5L	MD7208E15PA1	 7208E15	
MD7208E18	1.8	SOT89-5L	MD7208E18PA1	 7208E18	
MD7208E21	2.1	SOT89-5L	MD7208E21PA1	 7208E21	
MD7208E25	2.5	SOT89-5L	MD7208E25PA1	 7208E25	
MD7208E27	2.7	SOT89-5L	MD7208E27PA1	 7208E27	
MD7208E28	2.8	SOT89-5L	MD7208E28PA1	 7208E28	
MD7208E30	3.0	SOT89-5L	MD7208E30PA1	 7208E30	
MD7208E33	3.3	SOT89-5L	MD7208E33PA1	 7208E33	
MD7208E36	3.6	SOT89-5L	MD7208E36PA1	 7208E36	
MD7208E38	3.8	SOT89-5L	MD7208E38PA1	 7208E38	
MD7208E40	4.0	SOT89-5L	MD7208E40PA1	 7208E40	
MD7208E50	5.0	SOT89-5L	MD7208E50PA1	 7208E50	
MD7208EC0	12.0	SOT89-5L	MD7208EC0PA1	 7208EC0	
MD7208F33	3.3	SOT223-3L	MD7208F33YA2	 7208F33	
MD7208F36	3.6	SOT223-3L	MD7208F36YA2	 7208F36	
MD7208F38	3.8	SOT223-3L	MD7208F38YA2	 7208F38	
MD7208F40	4.0	SOT223-3L	MD7208F40YA2	 7208F40	
MD7208F50	5.0	SOT223-3L	MD7208F50YA2	 7208F50	
MD7208FC0	12.0	SOT223-3L	MD7208FC0YA2	 7208FC0	
MD7208E12	1.2	SOT23-5L	MD7208E12QC3	 7208E12	Tape and Reel, 3000pcs
MD7208E15	1.5	SOT23-5L	MD7208E15QC3	 7208E15	
MD7208E18	1.8	SOT23-5L	MD7208E18QC3	 7208E18	
MD7208E21	2.1	SOT23-5L	MD7208E21QC3	 7208E21	
MD7208E25	2.5	SOT23-5L	MD7208E25QC3	 7208E25	
MD7208E27	2.7	SOT23-5L	MD7208E27QC3	 7208E27	
MD7208E28	2.8	SOT23-5L	MD7208E28QC3	 7208E28	
MD7208E30	3.0	SOT23-5L	MD7208E30QC3	 7208E30	
MD7208E33	3.3	SOT23-5L	MD7208E33QC3	 7208E33	
MD7208E36	3.6	SOT23-5L	MD7208E36QC3	 7208E36	
MD7208E38	3.8	SOT23-5L	MD7208E38QC3	 7208E38	
MD7208E40	4.0	SOT23-5L	MD7208E40QC3	 7208E40	
MD7208E50	5.0	SOT23-5L	MD7208E50QC3	 7208E50	
MD7208EC0	12.0	SOT23-5L	MD7208EC0QC3	 7208EC0	
MD7208E12	1.2	SOT23-3L	MD7208E12QA3	 7208E12	
MD7208E15	1.5	SOT23-3L	MD7208E15QA3	 7208E15	
MD7208E18	1.8	SOT23-3L	MD7208E18QA3	 7208E18	
MD7208E21	2.1	SOT23-3L	MD7208E21QA3	 7208E21	
MD7208E25	2.5	SOT23-3L	MD7208E25QA3	 7208E25	
MD7208E27	2.7	SOT23-3L	MD7208E27QA3	 7208E27	
MD7208E28	2.8	SOT23-3L	MD7208E28QA3	 7208E28	
MD7208E30	3.0	SOT23-3L	MD7208E30QA3	7208E30	
MD7208E33	3.3	SOT23-3L	MD7208E33QA3	7208E33	

MD7208E36	3.6	SOT23-3L	MD7208E36QA3	 7208E36	
MD7208E38	3.8	SOT23-3L	MD7208E38QA3	 7208E38	
MD7208E40	4.0	SOT23-3L	MD7208E40QA3	 7208E40	
MD7208E50	5.0	SOT23-3L	MD7208E50QA3	 7208E50	
MD7208EC0	12.0	SOT23-3L	MD7208EC0QA3	 7208EC0	

Notes:

- 1* Customer can request to customize the output voltage ranged from 1.8V to 12V, if desired voltage is not found in the selections.
- 2* Customer can request customization of package choice.
- 3* Please pay attention to the MARKING of the product package type.

■ Absolute Maximum Ratings (Unless otherwise indicated: T_a=25°C)

PARAMETER	SYMBOL	RATINGS		UNITS
Input Voltage	V _{IN}	-0.3 ~ 20		V
Output Voltage	V _{OUT}	V _{SS} -0.3 ~ V _{IN} +0.3V		
Power Dissipation	P _D	SOT89-3L	1000	mW
		SOT89-5L	1000	
		SOT223-3L	1500	
		SOT23-5L	250	
		SOT23-3L	250	
Thermal Resistance	R _{θJA}	SOT89-3L	100	°C/W
		SOT89-5L	100	
		SOT223-3L	66	
		SOT23-5L	180	
		SOT23-5L	200	
Operating Ambient Temperature	T _{opr}	-40 ~ +85		°C
Storage Temperature	T _{stg}	-40 ~ +125		
ESD Protection	ESD HBM	4000		V

Note: Stresses above those listed under “Absolute Maximum Ratings” may cause permanent damage to the device.

■ Electrical Characteristics:

MD7208 Series (Unless otherwise indicated: $T_a=25^\circ\text{C}$)

PARAMETER	SYMBOL	CONDITIONS		MIN.	TYP.	MAX.	UNIT
Output Voltage ^{*1}	$V_{OUT(S)}$	$V_{IN} = V_{OUT(S)} + 2V, I_{OUT} = 1\text{mA}$		$V_{OUT(S)} \times 0.98$	$V_{OUT(S)}$	$V_{OUT(S)} \times 1.02$	V
Dropout Voltage ^{*2}	V_{DROP}	$V_{OUT(S)} = 3.3V$	$I_{OUT} = 1\text{mA}$		3	8	mV
			$I_{OUT} = 500\text{mA}$		450	1000	
Line Regulation	$\frac{\Delta V_{OUT}}{\Delta V_{IN} \cdot V_{OUT(S)}}$	$V_{OUT(S)} + 2V \leq V_{IN} \leq 18V$ $I_{OUT} = 1\text{mA}$			0.01	0.02	%/V
Load Regulation	ΔV_{OUT2}	$V_{IN} = V_{OUT(S)} + 2V$ $1\text{mA} \leq I_{OUT} \leq 500\text{mA}$	$V_{OUT(S)} \leq 5.0V$		80		mV
			$V_{OUT(S)} > 5.0V$		90		
Temperature Stability	$\frac{\Delta V_{OUT}}{\Delta T_a \cdot V_{OUT(S)}}$	$V_{IN} = V_{OUT(S)} + 2V, I_{OUT} = 1\text{mA}$ $-40^\circ\text{C} \leq T_a \leq 125^\circ\text{C}$			± 50		ppm/ $^\circ\text{C}$
GND Current	I_{GND}	no load	$V_{OUT(S)} \leq 5.0V$	1	1.6	2	μA
			$V_{OUT(S)} > 5.0V$	1.5	2.3	3	
			$I_{OUT} = 100\text{mA}$		420		
Shutdown Current	I_{SHUT}	$V_{IN} = 18V, V_{EN} = 0$			0.1	1	
Input Voltage	V_{IN}	---		2.2		18	V
Maximum Output Current	I_{OUTMAX}			500			A
Current Limit ^{*3}	I_{LIM}	$V_{IN} = V_{OUT(S)} + 2V,$ $V_{OUT} = 0.95 \times V_{OUT(S)}$			800		
Power Supply Rejection Ratio ^{*4}	PSRR	$f = 10\text{Hz}, I_{OUT} = 10\text{mA}$			75		dB
		$f = 100\text{Hz}, I_{OUT} = 10\text{mA}$			80		
		$f = 1\text{kHz}, I_{OUT} = 10\text{mA}$			65		
Short Circuit Current ^{*5}	I_{SHORT}	$V_{IN} = V_{OUT(S)} + 2.0V$ $V_{OUT} = 0V$			30		mA
EN 'H' Level Voltage	V_{ENH}			1.5		18	V
EN 'L' Level Voltage	V_{ENL}			0		0.5	
EN 'H' Level Current	I_{ENH}	$V_{IN} = 18V, V_{EN} = V_{IN}$		-0.1		0.1	μA
EN 'L' Level Current	I_{ENL}	$V_{IN} = 18V, V_{EN} = 0$		-0.1		0.1	
Over Temperature Protection	OTP	$I_{OUT} = 1\text{mA}$			150		$^\circ\text{C}$

Notes:

- $V_{OUT(S)}$: Output voltage when $V_{IN} = V_{OUT} + 2V, I_{OUT} = 1\text{mA}$.
- $V_{DROP} = V_{IN1} - (V_{OUT(S)} \times 0.98)$ where V_{IN1} is the input voltage when $V_{OUT} = V_{OUT(S)} \times 0.98$.
- I_{LIM} : Output current when $V_{IN} = V_{OUT(S)} + 2V$ and $V_{OUT} = 0.95 \times V_{OUT(S)}$.
- PSRR was measured for $V_{OUT(S)} = 3.3V$ and $V_{IN} = 5.3V$.
- V_{OUT} pin should be shorted to GND pin, and the impedance between them is less than 0.1 ohm

■ Typical Performance Characteristics:

Test Conditions: $V_{IN}=V_{OUT}+2.0V$, $C_{IN}=2.2\mu F$, $C_{OUT}=2.2\mu F$, unless otherwise indicated.

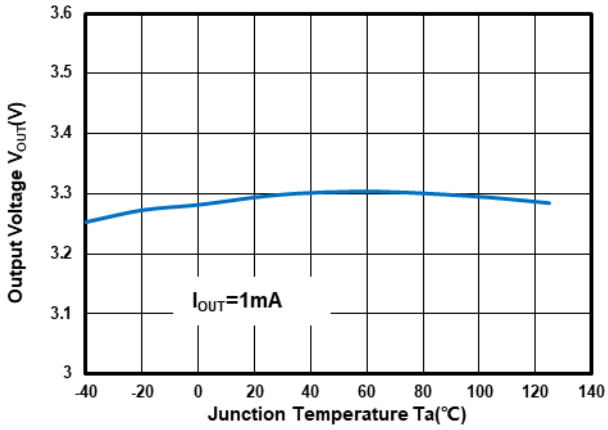

Output Voltage vs Temperature at $V_{OUT}=3.3V$

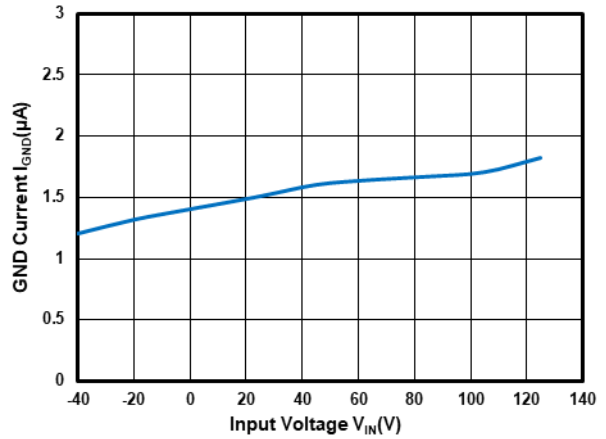

GND Current vs Temperature at $V_{OUT}=3.3V$

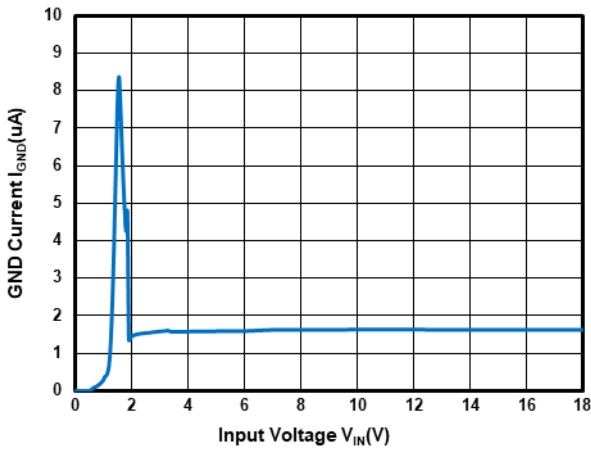

GND Current vs Input Voltage at $V_{OUT}=3.3V$

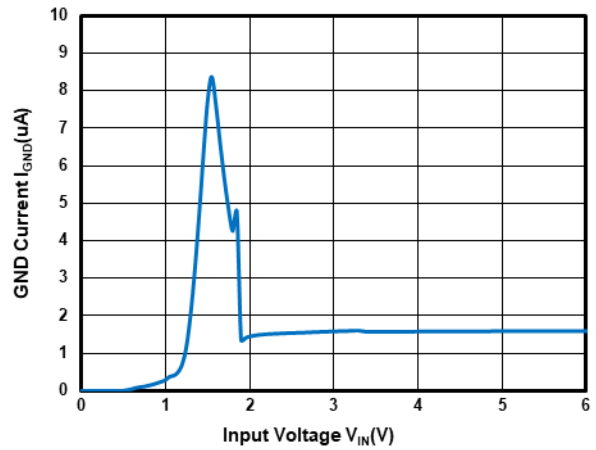

GND Current vs Input Voltage at $V_{OUT}=3.3V$

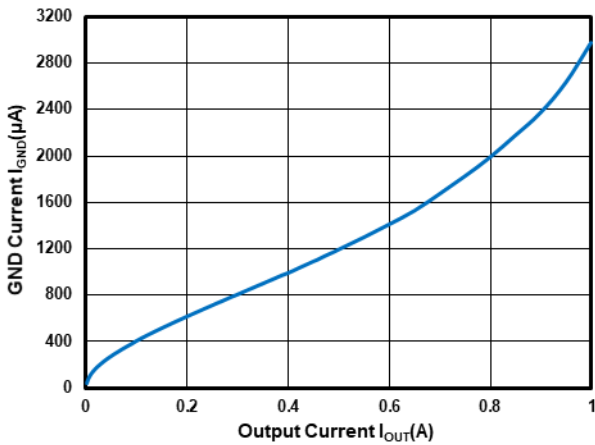

GND Current vs Output Current at $V_{OUT}=3.3V$

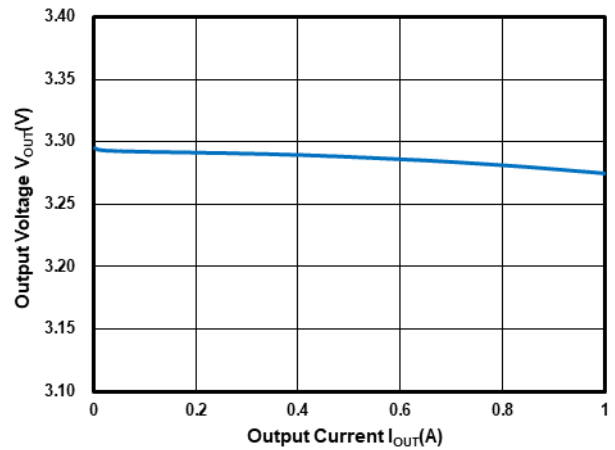

Output Voltage vs Output Current at $V_{OUT}=3.3V$

■ Typical Performance Characteristics (Continued):

Test Conditions: $V_{IN}=V_{OUT}+2.0V$, $C_{IN}=2.2\mu F$, $C_{OUT}=2.2\mu F$, unless otherwise indicated.

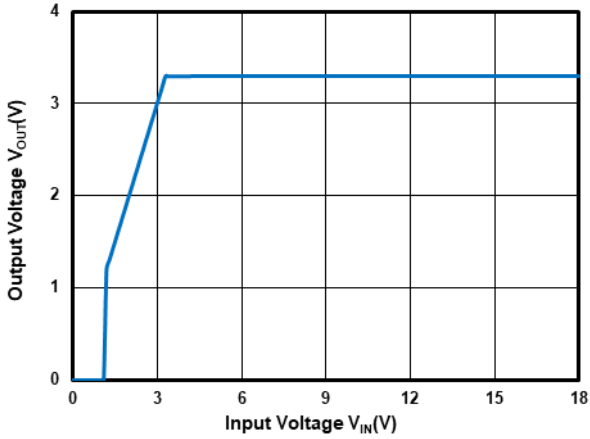

Output Voltage vs Input Voltage at $V_{OUT}=3.3V$

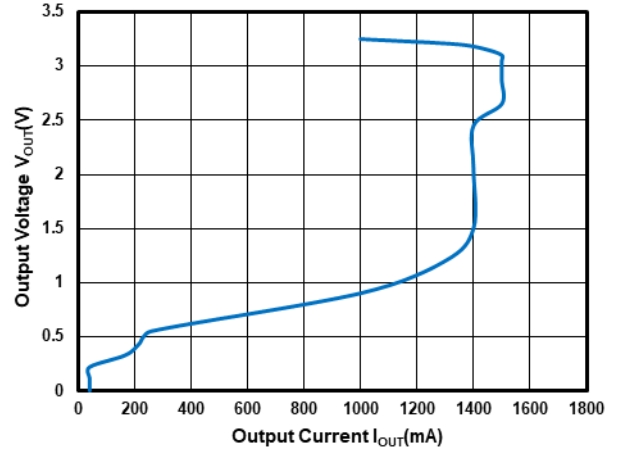

Output Current Fold-back at $V_{OUT}=3.3V$

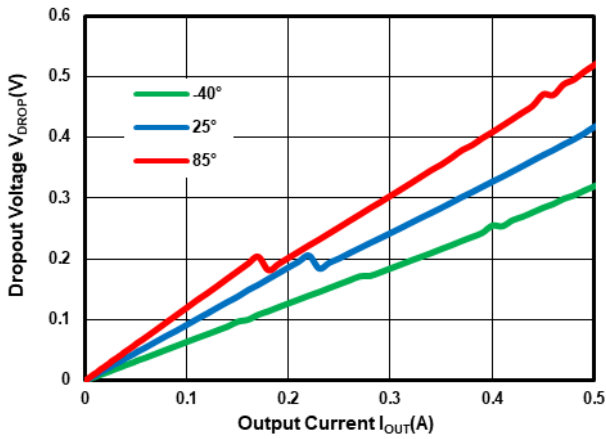

Dropout Voltage vs Temperature at $V_{OUT}=3.3V$

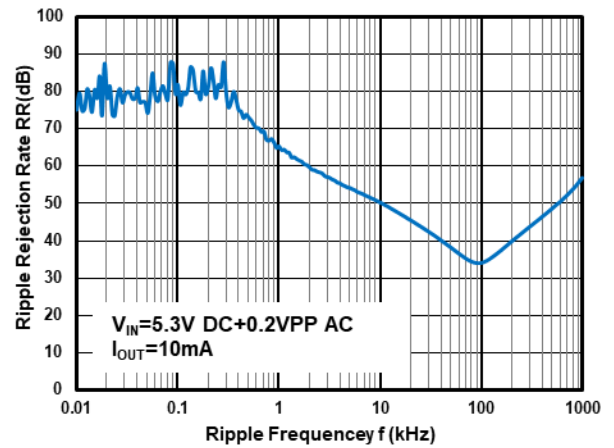

Power Supply Rejection Ratio at $V_{OUT}=3.3V$

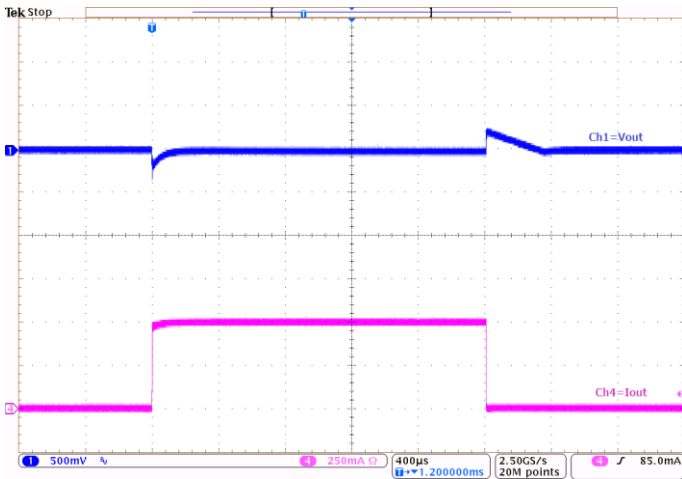

Load Transient at $V_{OUT}=3.3V$
($I_{OUT}=1mA\sim 500mA\sim 1mA$)

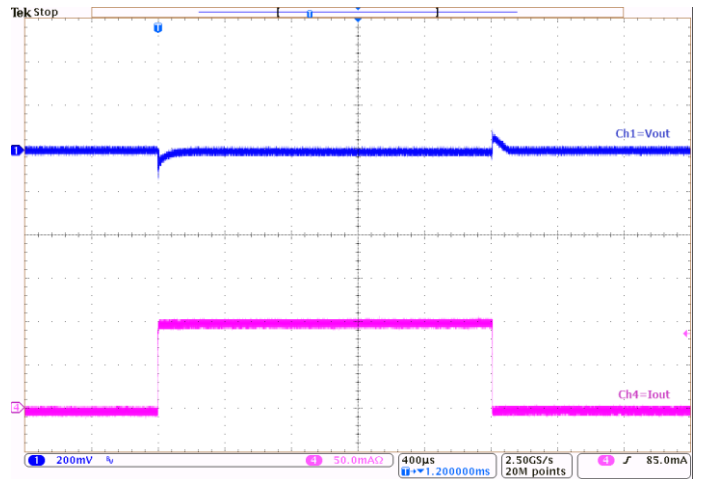

Load Transient at $V_{OUT}=3.3V$
($I_{OUT}=1mA\sim 100mA\sim 1mA$)

■ Typical Performance Characteristics (Continued):

Test Conditions: $V_{IN}=V_{OUT}+2.0V$, $C_{IN}=2.2\mu F$, $C_{OUT}=2.2\mu F$, unless otherwise indicated.

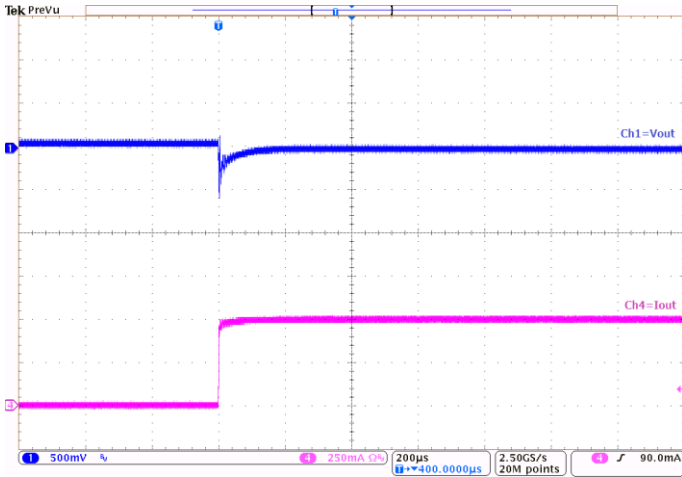

Load Transient at $V_{OUT}=3.3V$
($I_{OUT}=0mA\sim 500mA$)

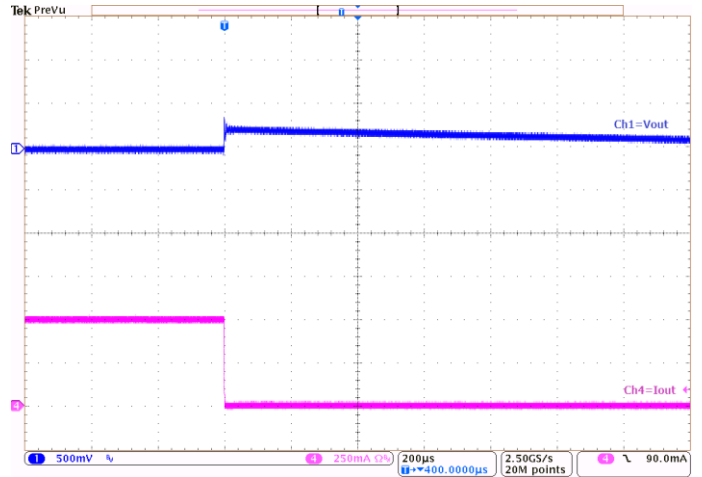

Load Transient at $V_{OUT}=3.3V$
($I_{OUT}=500mA\sim 0mA$)

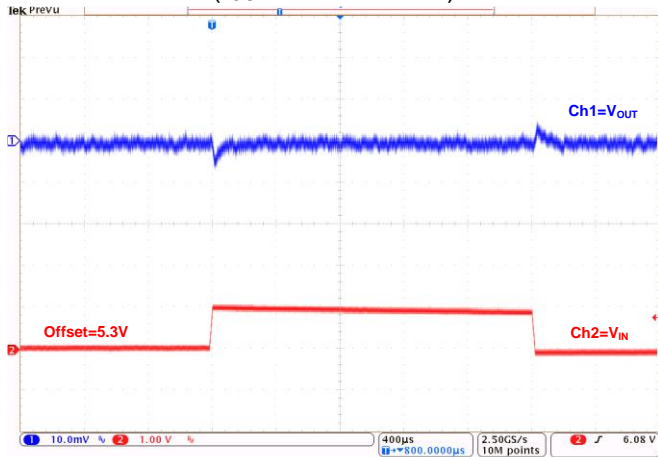

Line Transient at $V_{OUT}=3.3V$
($I_{OUT}=1mA$)

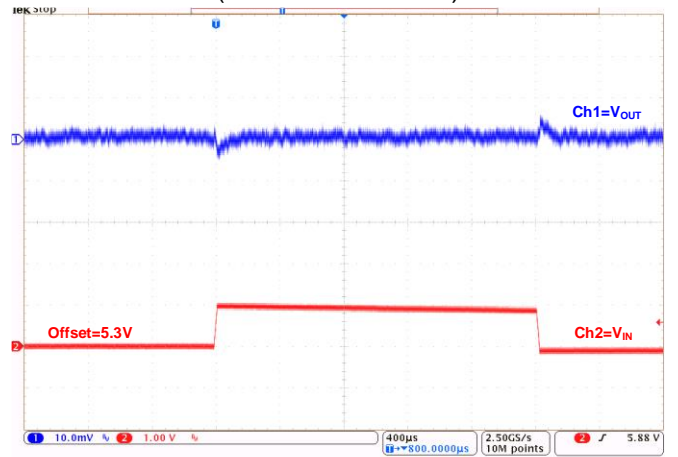

Line Transient at $V_{OUT}=3.3V$
($I_{OUT}=10mA$)

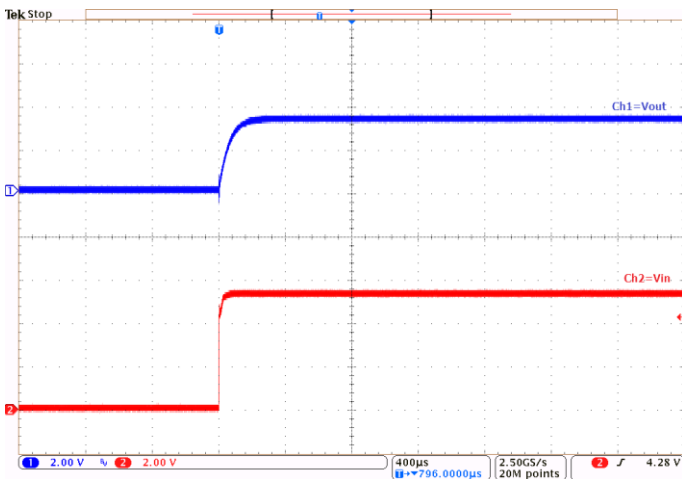

Power-Up at $V_{OUT}=3.3V$:
($I_{OUT}=1mA$)

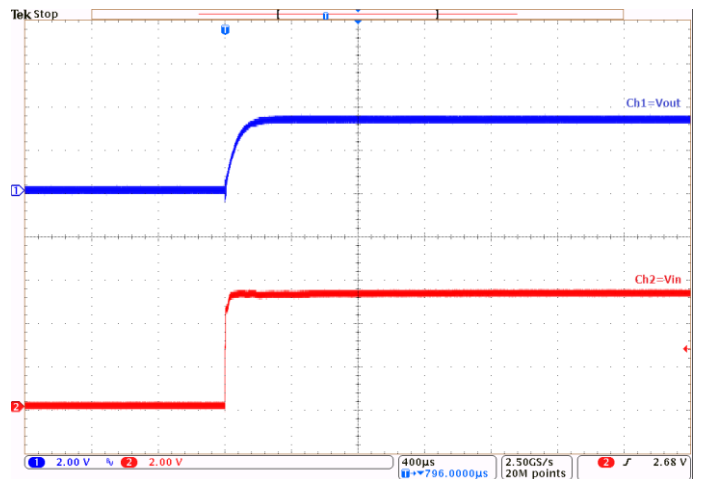

Power-Up at $V_{OUT}=3.3V$:
($I_{OUT}=500mA$)

■ Typical Performance Characteristics (Continued):

Test Conditions: $V_{IN}=V_{OUT}+2.0V$, $C_{IN}=2.2\mu F$, $C_{OUT}=2.2\mu F$, unless otherwise indicated.

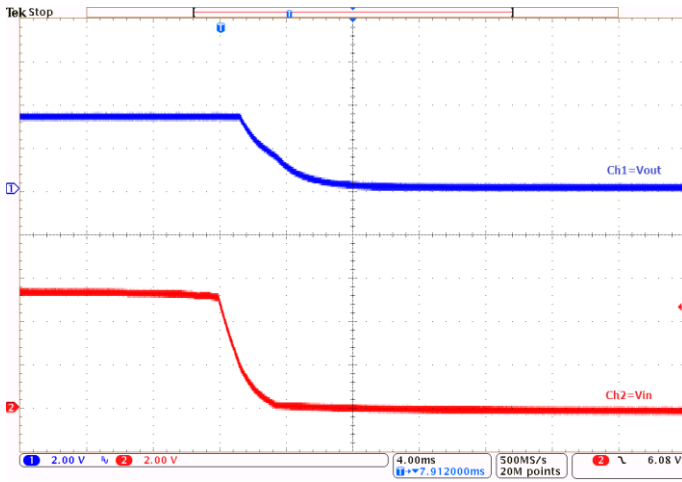

Power-Down at $V_{OUT}=3.3V$:
($I_{OUT}=1mA$)

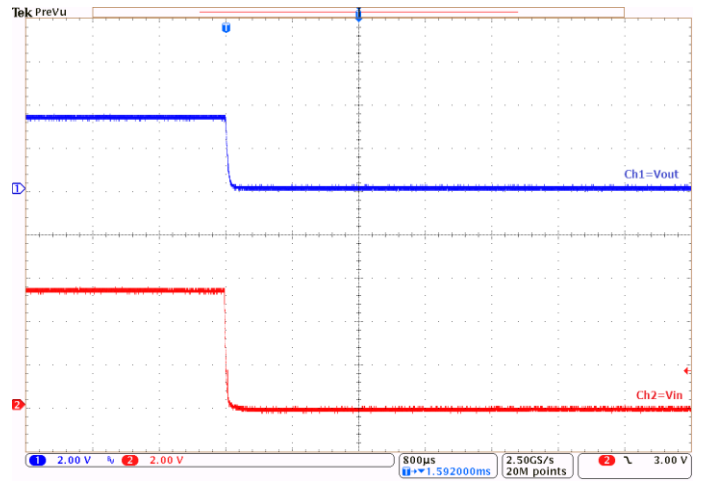

Power-Down at $V_{OUT}=3.3V$:
($I_{OUT}=500mA$)

■ **Operational Explanation**

Output voltage control

The voltage divided by resistors R1 and R2 is compared with the internal reference voltage by the error amplifier. The amplifier output then drives the P-channel MOSFET connected to the V_{OUT} pin. The output voltage at the V_{OUT} pin is regulated by this negative feedback system. The current limit circuit and short protect circuit operate in relation to output current level. Further, the IC's internal circuitry can be in operation or shutdown modes controlled by the CE pin's signal.

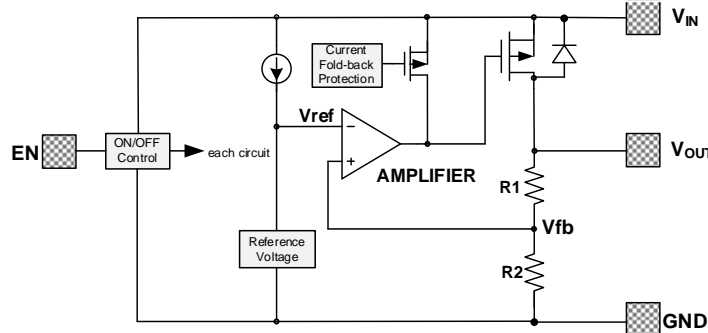

■ **Pass transistor**

The pass transistor with low turn-on resistance used in MD7208 is a P-channel MOSFET. If the potential on V_{OUT} pin is higher than V_{IN} , it is possible that IC will be destroyed due to reverse current which is caused by parasitic diodes between V_{IN} and V_{OUT} . Therefore, the V_{OUT} pin potential exceeds $V_{IN}+0.3V$ is not allowed.

■ **Current limit, over temperature protection**

The MD7208 series includes a combination of a fixed current limiter circuit which aid the operations of the current limiter and circuit protection. When the load current reaches the current limit level, the fixed current limiter circuit operates and output voltage drops. As a result of this drop in output voltage, the foldback circuit operates, output voltage drops further and output current decreases.

Special attention should be paid to that the product of the dropout voltage on the chip and the output current must be smaller than the heat dissipation. If power consumption on the chip is more than the heat dissipation, OTP will protect the chip from damaging due to over temperature.

■ **Notes:**

1. The input and output capacitors should be placed as close as possible to the IC.
2. If the impedance of the power supply is high, which is caused by forgetting installing input capacitor or installing too small value capacitor, the oscillation may occur.
3. Pay attention to the operation conditions of input and output voltage and load current, such that the power consumption in the IC should not exceed the allowable power consumption of the package even though the chip has short circuit protection.
4. IC has a built-in anti-static protection (ESD) circuit, but please do not add excessive stress to the IC.

■ Packaging Information

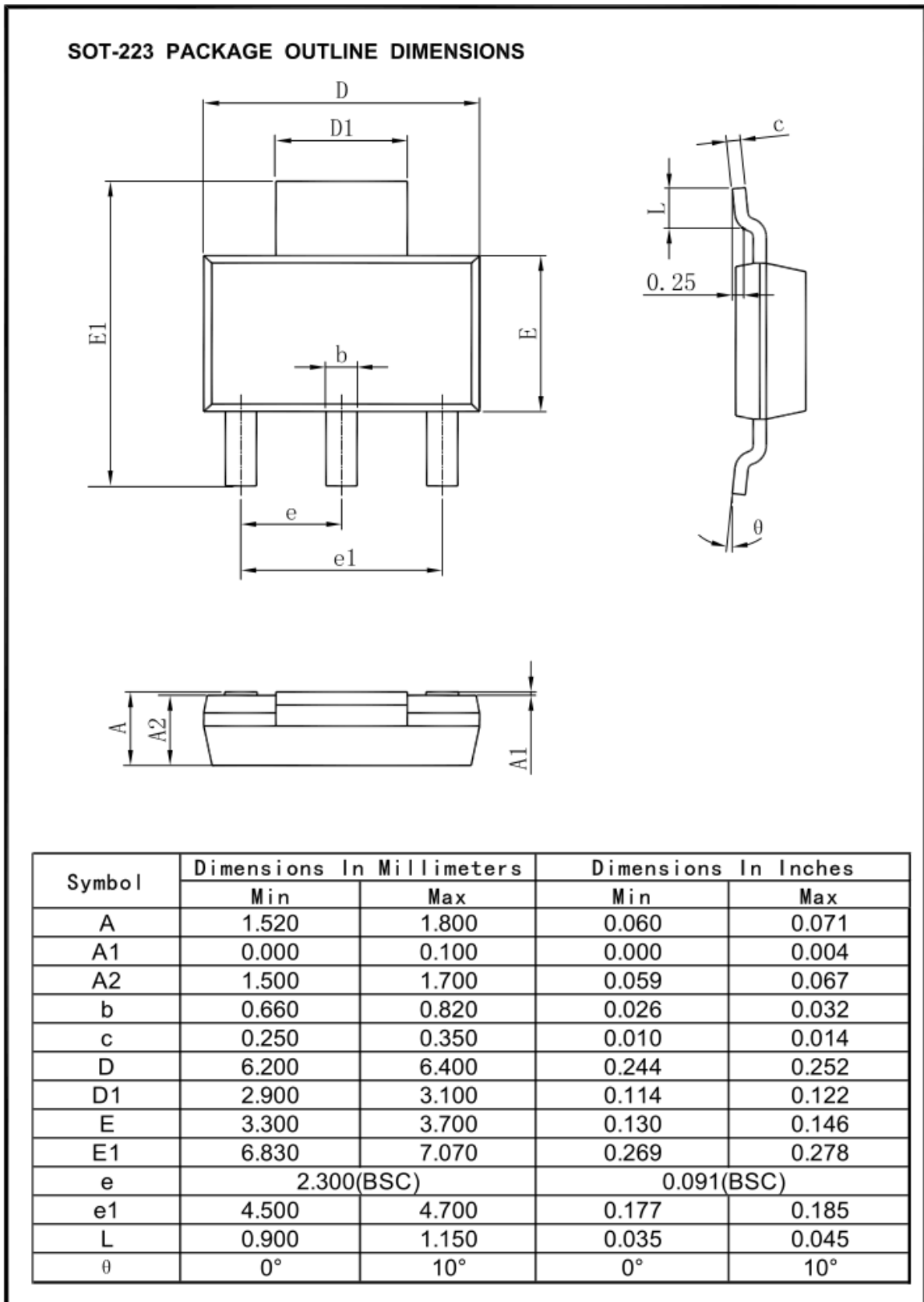

■ Packaging Information (Continued)

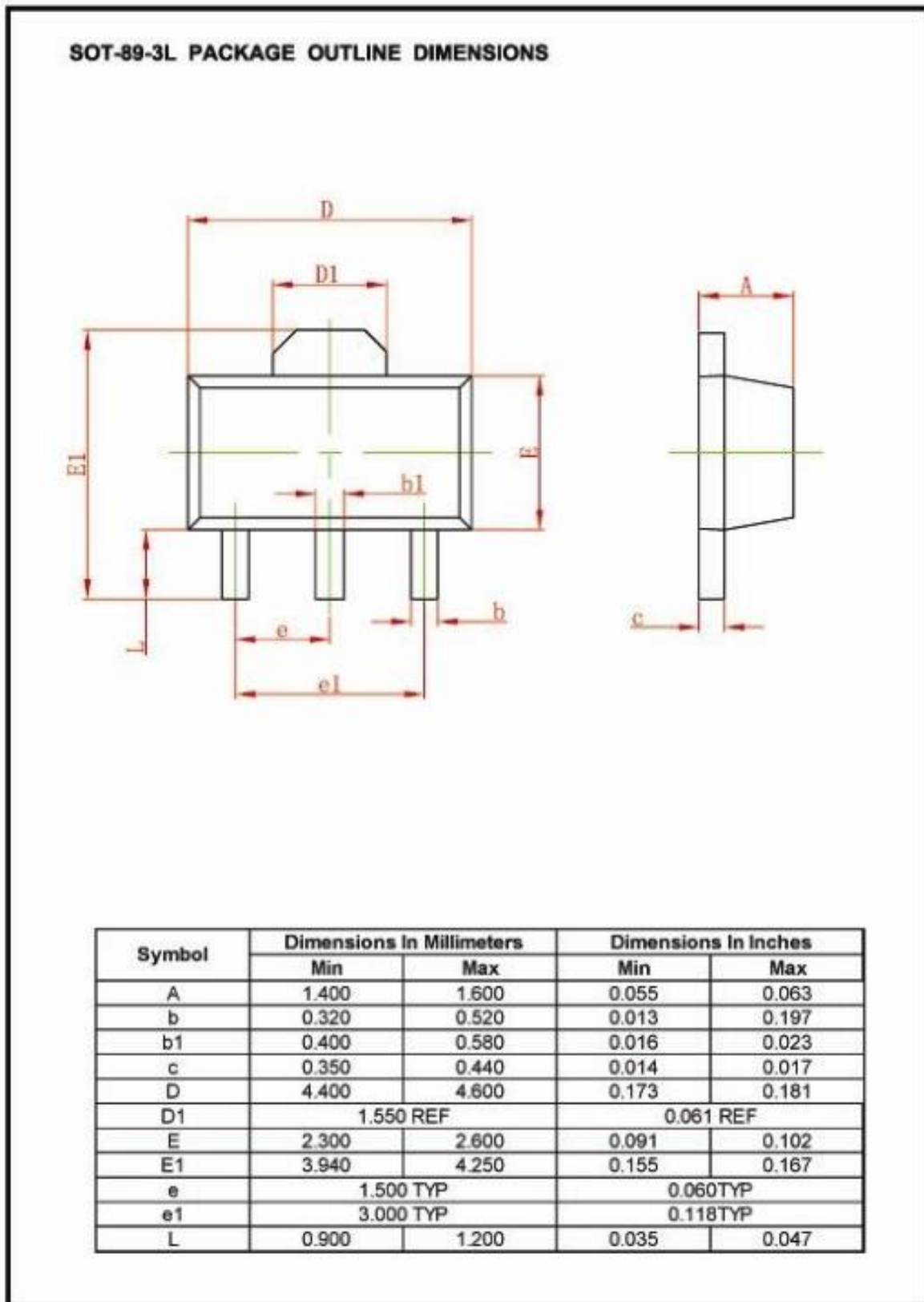

■ Packaging Information (Continued)

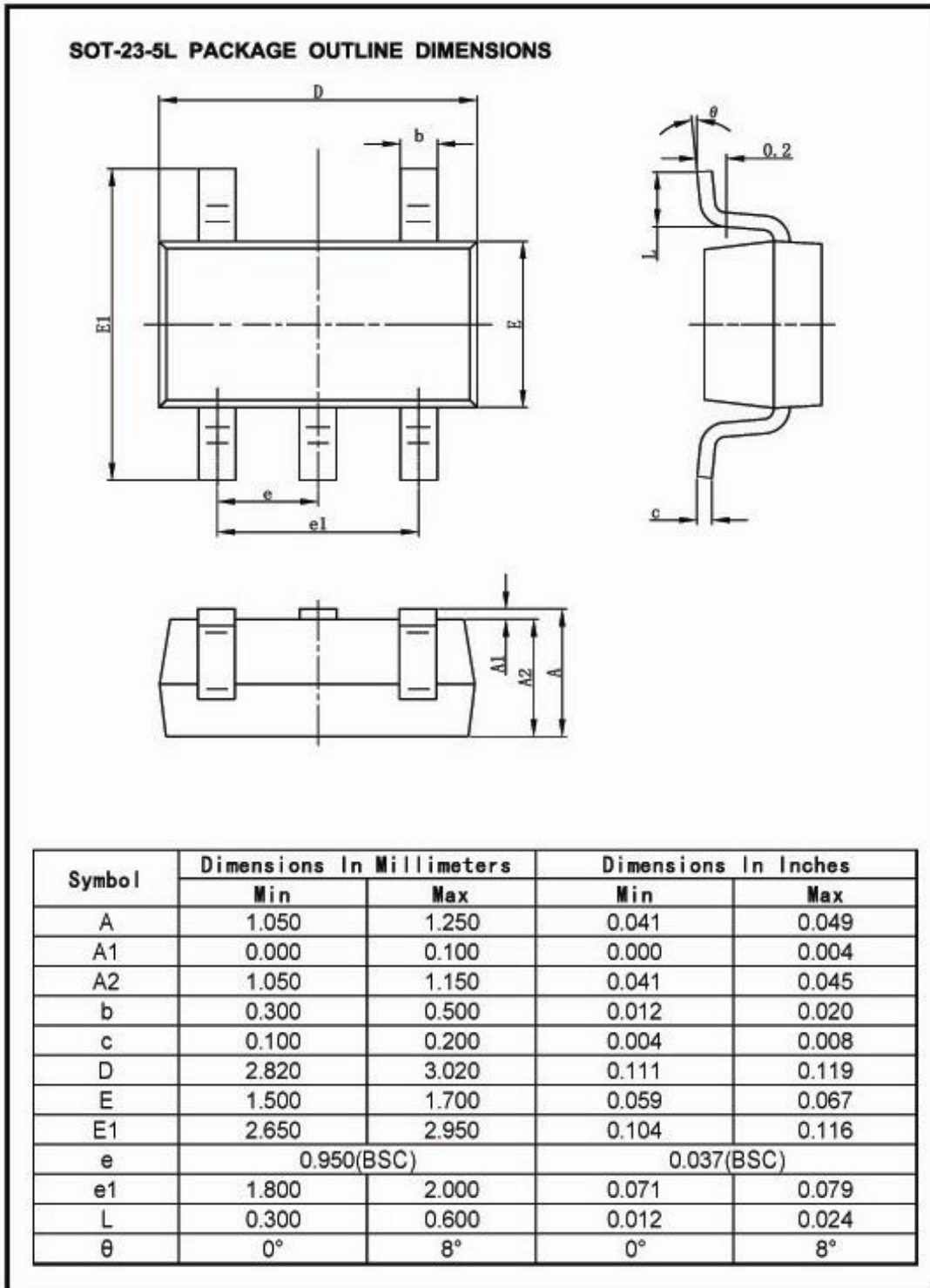

■ Packaging Information (Continued)

SOT-89-5L PACKAGE OUTLINE DIMENSIONS

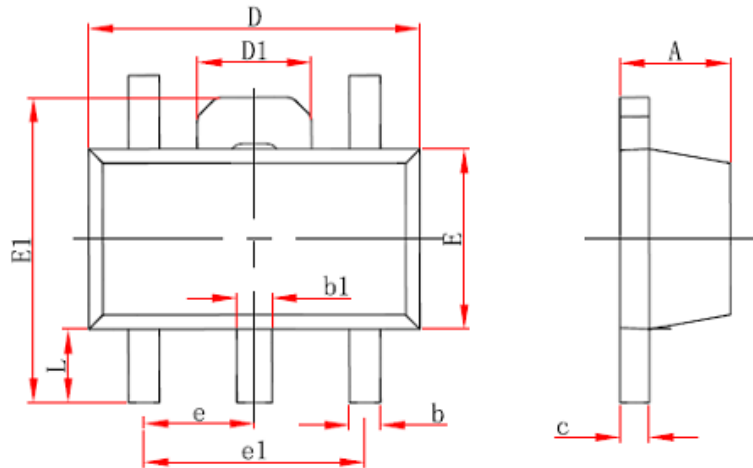

Symbol	Dimensions In Millimeters		Dimensions In Inches	
	Min.	Max.	Min.	Max.
A	1.400	1.600	0.055	0.063
b	0.320	0.520	0.013	0.020
b1	0.380	0.580	0.015	0.023
c	0.350	0.440	0.014	0.017
D	4.400	4.600	0.173	0.181
D1	1.550 REF.		0.061 REF.	
E	2.300	2.600	0.091	0.102
E1	3.940	4.250	0.155	0.167
e	1.500 TYP.		0.060 TYP.	
e1	3.000 TYP.		0.118 TYP.	
L	0.900	1.200	0.035	0.047

■ Packaging Information (Continued)

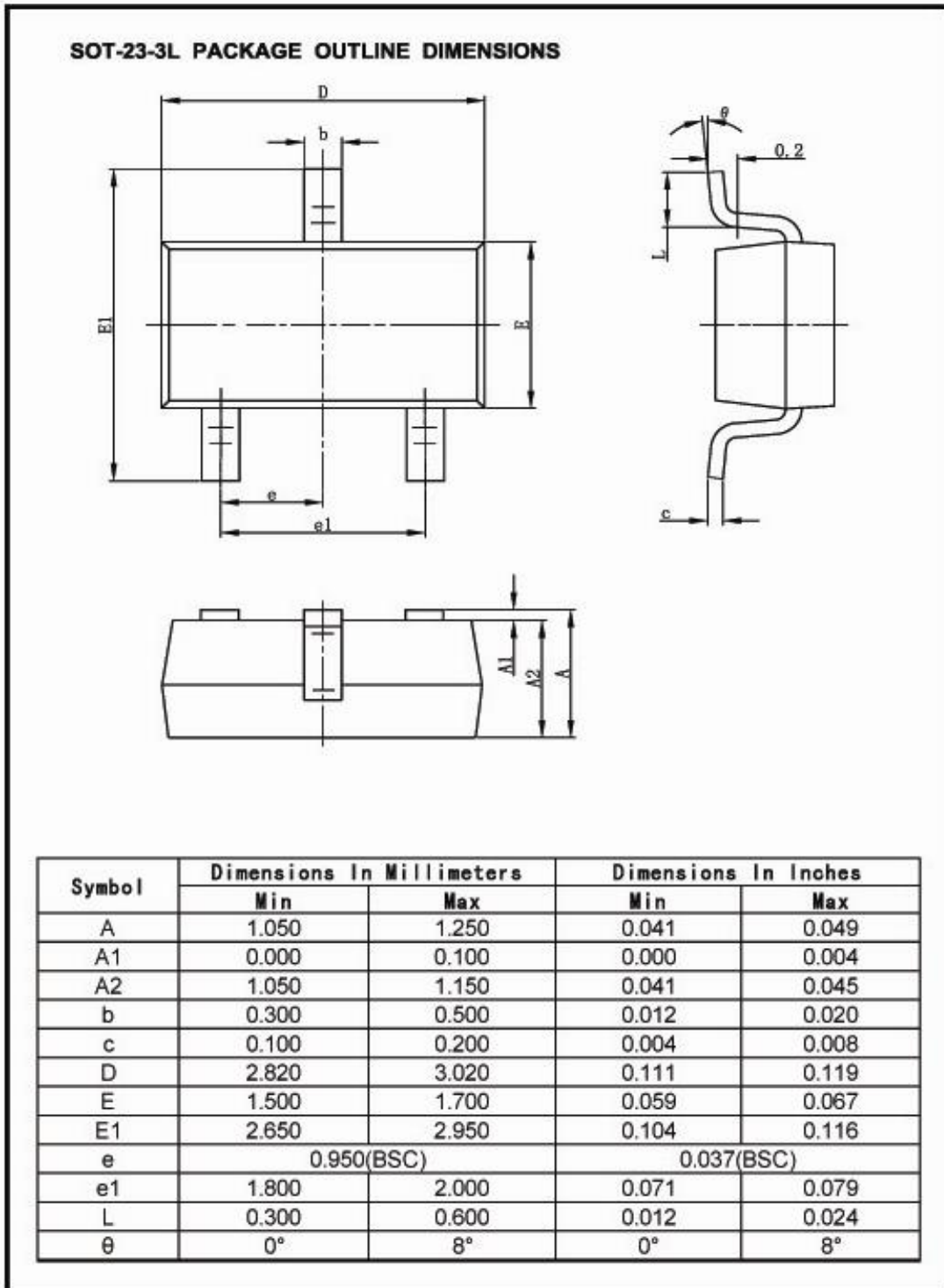

For the newest datasheet, please see the website:

www.md-ic.com.cn

Version V1.0 : 20220718