

## FEATURES

- Wide Input Voltage from 2.7V to 6V
- Adjustable Output Voltage from 0.61V to VIN
- 6A Continuous Output Current
- Constant on Time (COT) Control
- Forced Continuous Conduction Mode (FCCM) for light load
- Stable with low ESR Ceramic Capacitors
- 1.2MHz Switching Frequency
- 100% Duty Cycle Operation for Low Dropout
- Junction Temperature Range from  $-40^{\circ}\text{C}$  to  $125^{\circ}\text{C}$
- Power Good (PG) Indicator
- Programable Soft-Start Time
- Cycle-by-Cycle Output Current Limit Protection
- Short Circuit and Over-Load Hiccup Protection
- Thermal Shutdown Protection
- LGA-24 (4.0mm×6.0mm×1.82mm) Package
- Pb-Free RoHS Compliant

## APPLICATIONS

- Optical Module
- POL Power Supply
- Data Center
- Solid-State and Hard Disk Drives
- Industrial & Medical System

## DESCRIPTION

The M0506 is a 6A step-down switching mode Power SoC (System on Chip) with integrated controller, power MosFETs, inductor and input decoupling capacitor in LGA-24 package. The input voltage is from 2.7V to 6V and the switching frequency is fixed at 1.2MHz.

The M0506 provides high efficiency with COT control mode for fast transient response and good loop stability. It works on FCCM which keeps low output ripple and supports 100% duty cycle for low dropout.

The M0506 indicates faults by PG and provides short circuit and over-load hiccup protection and over temperature shutdown protection.

## TYPICAL APPLICATION & EFFICIENCY

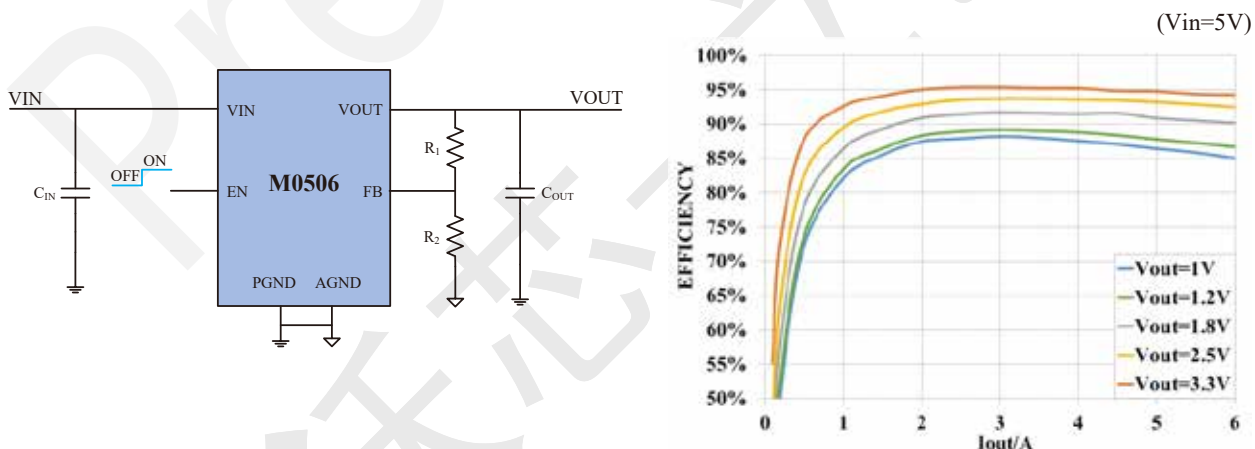

## ORDERING INFORMATION

PART NUMBER	TOP MARKING	PACKAGE	MOQ	MSL LEVEL
M0506DLDD	M0506 YWWLLL	LGA-24 (4.0mm×6.0mm×1.82mm)	1500/ Tape & Reel	3

NOTES: Y: Year, WW: Week, LLL: Lot Number.

## PACKAGE REFERENCE

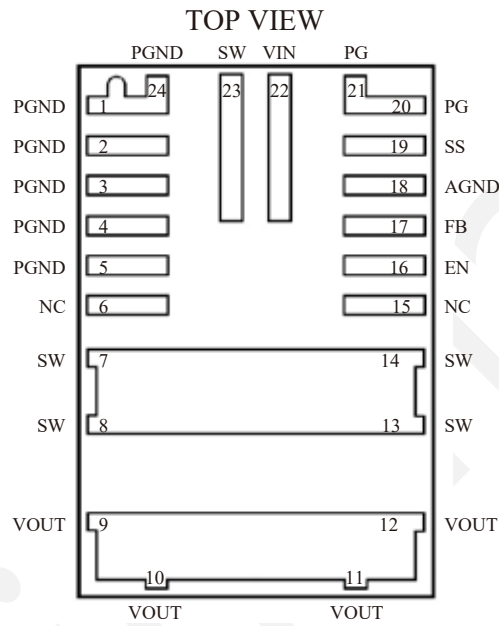

**PIN FUNCTIONS**

PIN #	NAME	DESCRIPTION
1,2,3,4,5,24	PGND	<b>Power Ground.</b>
6,15	NC	<b>Not Connected.</b>
7,8,13,14,23	SW	<b>Internal SW Pad.</b> Connect with copper pad for thermal dissipation.
9,10,11,12	VOUT	<b>Output Voltage Power Rail.</b> Connect this pin with the load. Output capacitor is recommended to be placed between VOUT and PGND
16	EN	<b>Enable Control.</b> Pull this pin low shuts the chip down. Pull it up high enables the chip.
17	FB	<b>Feedback.</b> Connect this pin with an external resistor divider from the output to AGND to set the output voltage.
18	AGND	<b>Analog Ground.</b>
19	SS	<b>Soft Start.</b> A decoupling ceramic capacitor is recommended to be placed close to this pin. The capacitance determines the soft-start time.
20,21	PG	<b>Power Good.</b> The output of PG is an open drain, and a pull-up resistor to power source is needed if used. If the chip works normally, PG is pulled high, else, PG is latched low.
22	VIN	<b>Input Voltage Power Rail.</b> VIN supplies power to all the internal control circuitry and the power switch. A decoupling capacitor to ground is recommended to be placed close to VIN directly.

**FUNCTIONAL BLOCK DIAGRAM**

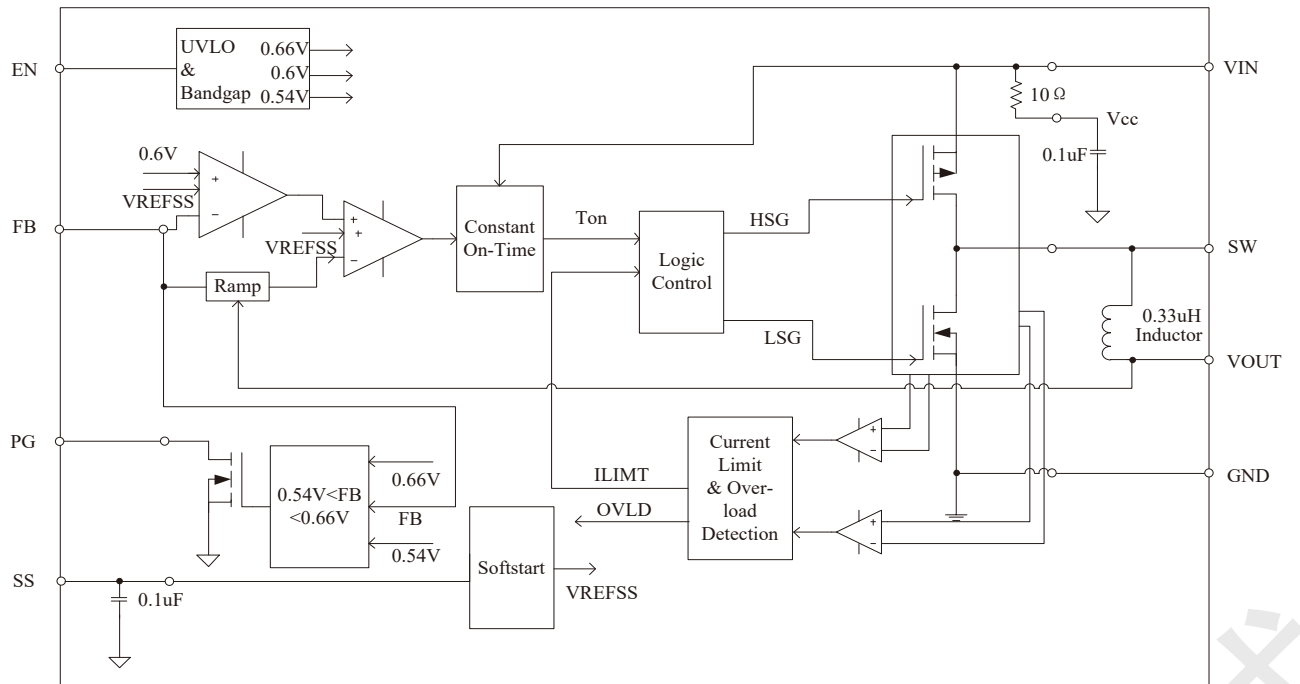

**ABSOLUTE MAXIMUM RATINGS**

	SYMBOL	MIN	MAX	UNIT
Voltage at Pins	$V_{IN}$	-0.3	6.5	V
Voltage at Other Pins		-0.3	6	V
Junction Temperature Range	$T_J$	-40	125	°C
Storage Temperature Range	$T_S$	-55	150	°C
Power Dissipation ( $T_A=+25^{\circ}\text{C}$ )	$P_D$ <sup>Note 1)</sup>		2.85	W

**RECOMMENDED OPERATING CONDITIONS**

	SYMBOL	MIN	MAX	UNIT
Input Voltage Range	$V_{IN}$	2.7	5.5	V
Output Voltage Range	$V_{OUT}$	0.61	$V_{IN}$	V
Output Current	$I_{OUT}$		6	A
Junction Temperature Range	$T_J$	-40	125	°C

**THERMAL RESISTANCE**

	SYMBOL	MIN	MAX	UNIT
Junction to Ambient	$\theta_{JA}$ <sup>Note 2)</sup>		35	°C/W
Junction to Case	$\theta_{JC}$ <sup>Note 2)</sup>		22	°C/W

**NOTES:**

- 1) The maximum allowable continuous power dissipation at any ambient temperature ( $T_A$ ) is calculated by  $P_D(\text{max})=(T_J(\text{max})-T_A)/\theta_{JA}$ . Exceeding the maximum allowable power dissipation will cause excessive die temperature, and the power module will go into thermal shutdown.
- 2) Measured on EVB, 4-layer PCB 2oz.

**ELECTRICAL CHARACTERISTICS** $V_{IN}=5V$ ,  $V_{OUT}=1V$ ,  $T_A=25^{\circ}C$ , unless otherwise noted.

PARAMETERS	SYMBOL	CONDITION	MIN	TYP	MAX	UNIT
Input Voltage	$V_{IN}$		2.7		6.0	V
Input under Voltage Lockout Threshold	$V_{UVLO}$	$V_{IN}$ Increasing	2.3	2.4	2.5	V
Input under Voltage Lockout Hysteresis			200	250	300	mV
Input over Voltage Lockout Threshold	$V_{OVLO}$	$V_{IN}$ Increasing	6.5	6.7	6.9	V
Input over Voltage Lockout Hysteresis			200	450	600	mV
Shutdown Current	$I_{SD}$	$V_{EN}=0$ , $V_{IN}=5.5V$		0.1	1	$\mu A$
Quiescent Current (No Switching)	$I_Q$	$V_{FB}=0.63V$	400	500	700	$\mu A$
EN On Threshold		$V_{EN}$ Increasing	1.17	1.20	1.23	V
EN off Threshold		$V_{EN}$ Decreasing	1.07	1.1	1.13	V
EN Internal Pull-Down Resistor			800	1000	1200	k $\Omega$
Feedback Voltage	$V_{FB\_REF}$		604	610	616	mV
HS Switch Current Limit			9.2	11	15	A
Switching Frequency	$F_{SW}$			1.2		MHz
Soft-Start Time	$T_{SS}$	$C_{SS}$ NC	5	6	7	ms
PG Output Low Voltage		$V_{FB}=5V$ , sink 1mA		0.2	0.3	V
PG Under Voltage Rise Threshold		$V_{FB}$ in respect to the regulation	-13	-10	-7	%
PG Under Voltage Hysteresis Threshold		$V_{FB}$ in respect to the regulation	-8	-5	-2	%
PG Over Voltage Fall Threshold		$V_{FB}$ in respect to the regulation	5	10	15	%
PG Over Voltage Hysteresis Threshold		$V_{FB}$ in respect to the regulation	2	4	8	%
PG Delay	$T_{PG\_DELAY}$		15	20	40	$\mu s$
Thermal Shutdown				160		$^{\circ}C$
Thermal Shutdown Hysteresis				30		$^{\circ}C$

## TYPICAL PERFORMANCE CHARACTERISTICS

$V_{IN}=5V$  and  $V_{OUT}=1V$ ,  $T_A=25^\circ C$ , unless otherwise noted.

### Line Regulation

$V_{OUT}=1V/1.2V/1.8V/2.5V/3.3V$ ,  $I_{OUT}=6A$ ,  
 $V_{IN}=2.7\sim 6V$

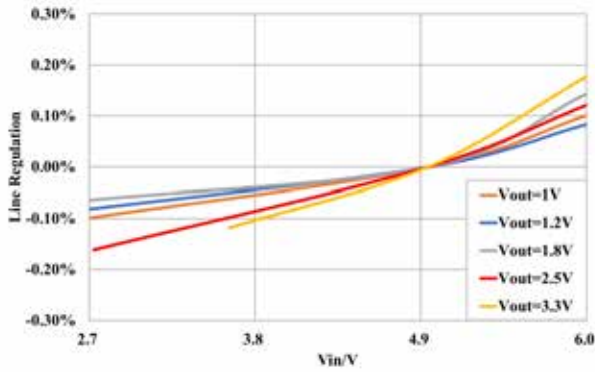

### Load Regulation

$V_{IN}=5V$ ,  $V_{OUT}=1V/1.2V/1.8V/2.5V/3.3V$ ,  
 $I_{OUT}=0\sim 6A$

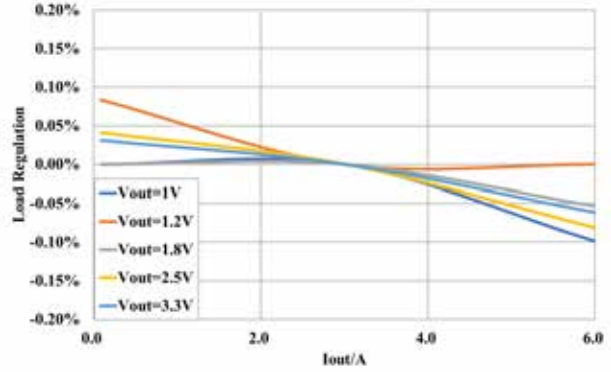

### Efficiency

$V_{IN}=5V$ ,  $V_{OUT}=1V/1.2V/1.8V/2.5V/3.3V$ ,  $I_{OUT}=0\sim 6A$

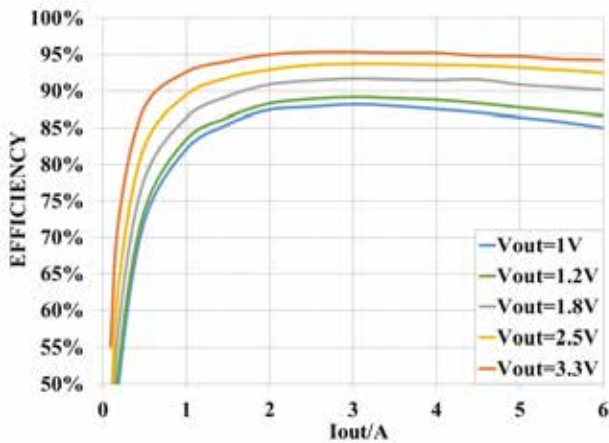

### Efficiency

$V_{IN}=3.3V$ ,  $V_{OUT}=1V/1.2V/1.8V/2.5V$ ,  $I_{OUT}=0\sim 6A$

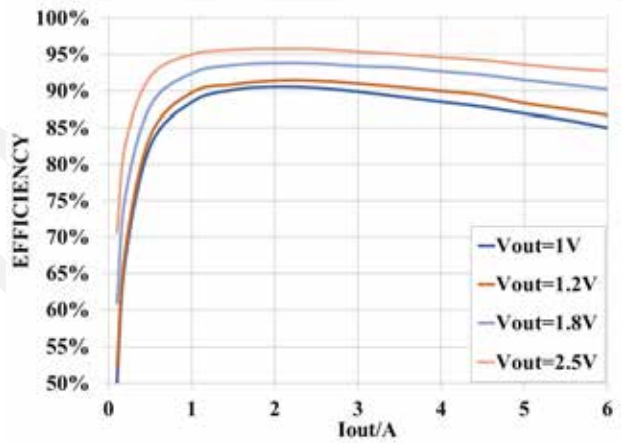

**TYPICAL PERFORMANCE CHARACTERISTICS (continued)**

$V_{IN}=5V$  and  $V_{OUT}=1V$ ,  $T_A=25^{\circ}C$ , unless otherwise noted.

**VIN Start up**

$I_{OUT}=0A$

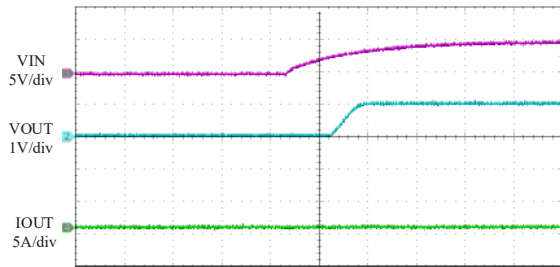

20ms/div

**VIN Start up**

$I_{OUT}=6A$

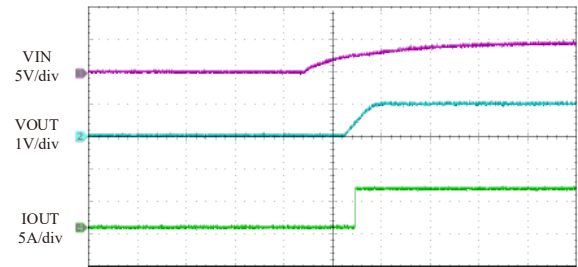

20ms/div

**VIN Shut down**

$I_{OUT}=0A$

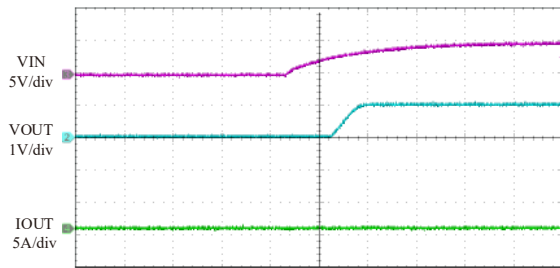

20ms/div

**VIN Shut down**

$I_{OUT}=6A$

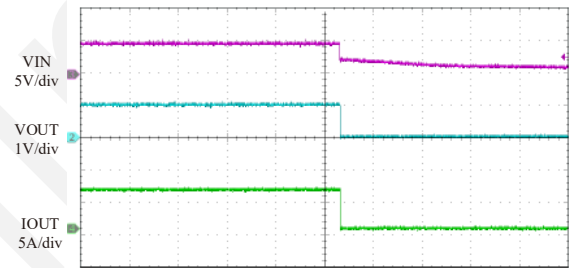

20ms/div

**EN Start up**

$I_{OUT}=0A$

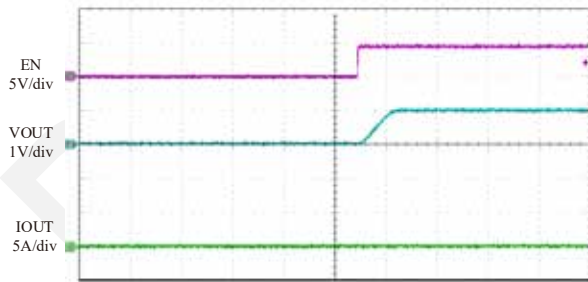

20ms/div

**EN Start up**

$I_{OUT}=6A$

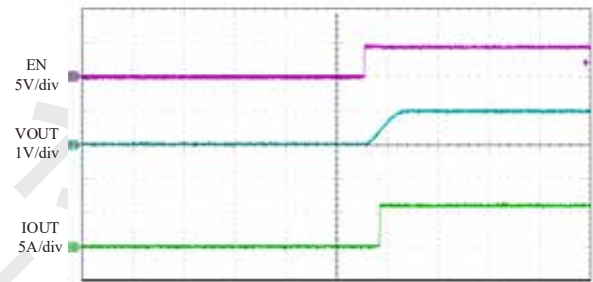

20ms/div



**TYPICAL PERFORMANCE CHARACTERISTICS (continued)**

$V_{IN}=5V$  and  $V_{OUT}=1V$ ,  $T_A=25^{\circ}C$ , unless otherwise noted.

**EN Shut down**

$I_{OUT}=0A$

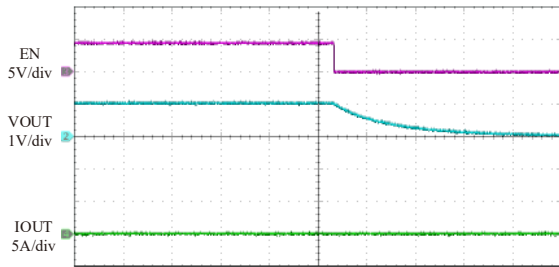

400ms/div

**EN Shut down**

$I_{OUT}=6A$

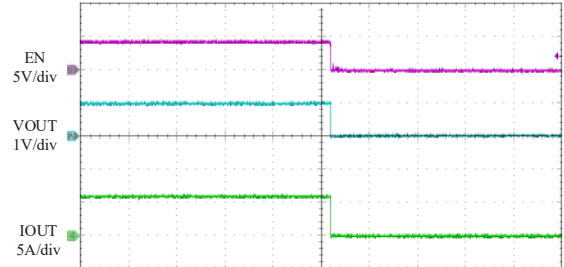

20ms/div

**SCP Enter**

$I_{OUT}=0A$

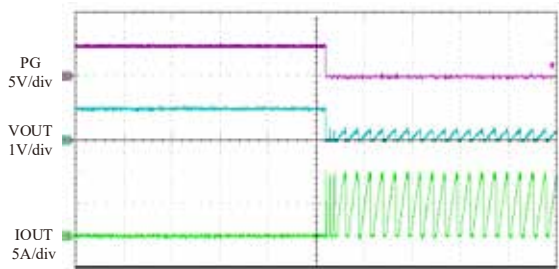

20ms/div

**SCP Enter**

$I_{OUT}=6A$

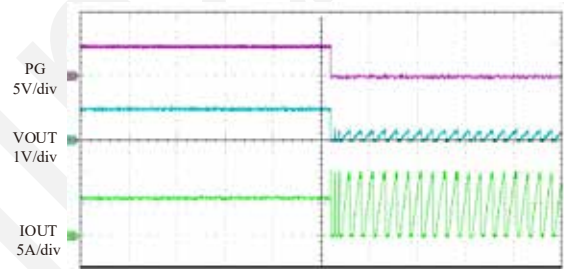

20ms/div

**SCP Recover**

$I_{OUT}=0A$

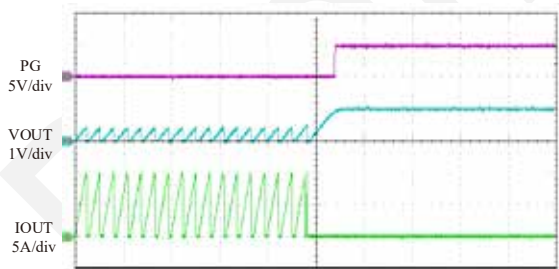

20ms/div

**SCP Recover**

$I_{OUT}=6A$

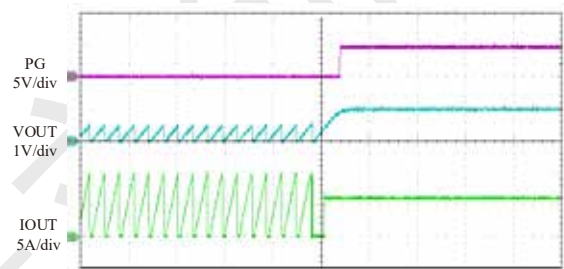

20ms/div

**TYPICAL PERFORMANCE CHARACTERISTICS (continued)**

$V_{IN}=5V$  and  $V_{OUT}=1V$ ,  $T_A=25^\circ C$ , unless otherwise noted.

**VOUT Ripple**

$I_{OUT}=0A$

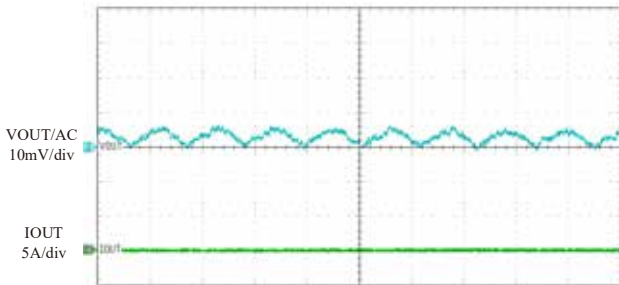

800ns/div

**VOUT Ripple**

$I_{OUT}=6A$

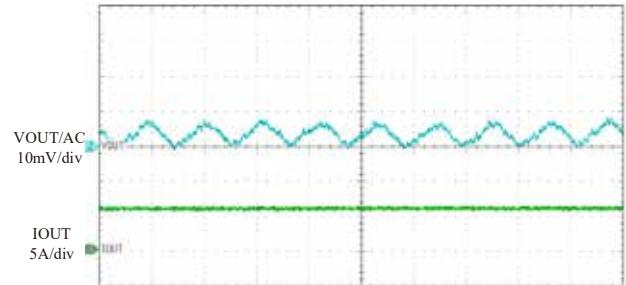

800ns/div

**Load Transient**

$I_{OUT}=0A$  to  $3A$ ,  $1A/\mu s$

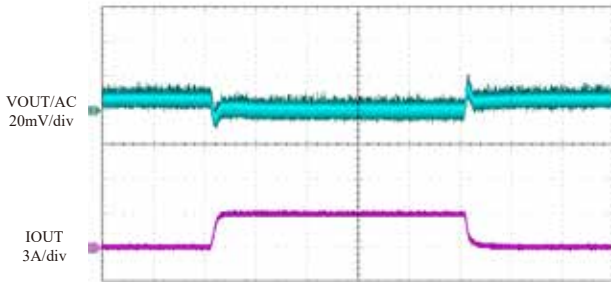

100µs/div

**Load Transient**

$I_{OUT}=3A$  to  $1A$ ,  $1A/\mu s$

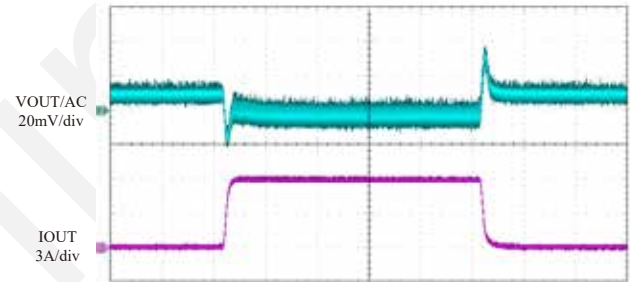

100µs/div

**Load Transient**

$I_{OUT}=0A$  to  $6A$ ,  $1A/\mu s$

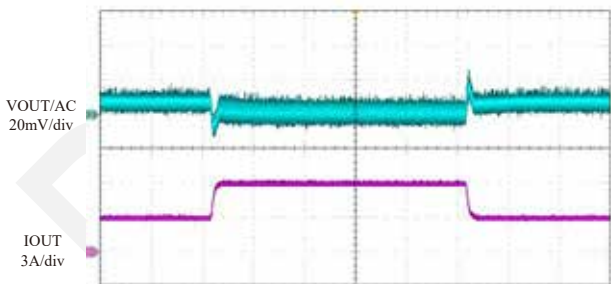

100µs/div

## OPERATION

The M0506 is a 6A synchronous step-down switching mode Power SoC with integrated high-side and low-side power MosFETs, inductor and input decoupling capacitor in LGA-24 (4.0mm×6.0mm×1.82mm) package. Only FB resistor divider, input and output capacitors are needed to complete the design over 2.7V to 6V input voltage range. The M0506 supports output voltage of 0.61V to 6V with the fixed switching frequency of 1.2MHz.

M0506 works on COT control mode that offers excellent transient response over the wide range of input voltage. M0506 operates in forced continuous conduction mode (FCCM) which keeps low output ripple. M0506 can work on 100% duty cycle when the dropout between input and output is low. The soft start time of M0506 is 6ms internally, which also can be programmed by the external capacitors.

Fully integrated protection features include OCP, UVP, OTP and all these faults can be indicated by PG. The

protection function details are shown below.

### OVER CURRENT PROTECTION (OCP)

M0506 has a typical cycle-by-cycle High-Side current limit protection to prevent inductor current from running away. When the High-Side switch reaches the current limit, M0506 will enter hiccup mode. It will stop switching for a pre-determined period of time and automatically start up again. It always starts up with soft-start to limit inrush current and avoid output overshoot.

### OVER TEMPERATURE PROTECTION (OTP)

M0506 will stop switching when the junction temperature exceeds 160 °C. The device will power up again when the junction temperature drops below 130°C.

## USER GUIDE

### Setting the Output Voltage

The output voltage is set by the external feedback resistor divider as the typical application circuit on Page 1. The bottom feedback resistor  $R_2$  can impact the loop stability, which is recommended to be between 10 k $\Omega$  and 60 k $\Omega$ . For any chosen  $R_2$ , the top feedback resistor  $R_1$  can be calculated as:

$$R_1 = R_2 \cdot \left( \frac{V_{OUT}}{V_{FB}} - 1 \right)$$

Table 1 lists the recommended feedback resistor values for common output voltages.

**Table 1: FB Resistor Values for Common Output Voltages.**

$V_{OUT}(V)$	$R_1(k\Omega)$	$R_2(k\Omega)$
3.3	133	30
1.8	60.4	30.9
1.2	30	30.9
1.0	19.3	30

And a feedforward capacitor  $C_{FF}$  is recommended for better load transient response, which typical value is 2.2nF.

### Input Capacitor Selection

The input current of the step-down converter is discontinuous with sharp edges, therefore, placing input filter capacitor is necessary. For better performance, low ESR ceramic capacitor with X5R or X7R dielectrics are highly recommended because of their lowest temperature variations. The RMS current of the input capacitor is calculated:

$$I_{CIN\_RMS} = I_{OUT} \sqrt{D(1-D)}$$

in which D is the Duty Cycle and when the current is continuous,  $D = V_{OUT}/V_{IN}$ ;  $I_{OUT}$  is the output load current. As the equation above, when D is 0.5, the highest RMS current is approximately:

$$I_{CIN\_RMS} = \frac{1}{2} \times I_{OUT}$$

So, it is recommended to choose the capacitors with the RMS current rating higher than  $1/2 I_{OUT}$ .

The power dissipation on the input capacitors can be estimated with the RMS current and the ESR resistor.

Electrolytic or tantalum capacitors can also be used. small size 0.1 $\mu$ F ceramic capacitor is recommended to be placed closed to  $V_{IN}$  and PGND. The input voltage ripple caused by the capacitor can be calculated as:

$$\Delta V_{CIN} = \frac{I_{OUT}}{F_{SW} \cdot C_{IN}} \cdot \frac{V_{OUT}}{V_{IN}} \cdot \left( 1 - \frac{V_{OUT}}{V_{IN}} \right)$$

in which,  $F_{SW}$  is switching frequency of 1.2MHz.

### Output Capacitor Selection

Output capacitors are required to keep stable output voltage. To minimize the output voltage ripple, low ESR ceramic capacitors should be used. The output voltage ripple can be estimated as:

$$\Delta V_{OUT} = \frac{V_{OUT}}{8F_{SW}^2 C_{OUT} L} \cdot \left( 1 - \frac{V_{OUT}}{V_{IN}} \right)$$

In which, L is the inductor, which value is fixed at 0.33 $\mu$ H internally.

If electrolytic or tantalum capacitor are used, the ESR will dominate the output voltage ripple as:

$$\Delta V_{OUT} = R_{ESR} \cdot \frac{V_{OUT}}{F_{SW} L} \cdot \left( 1 - \frac{V_{OUT}}{V_{IN}} \right)$$

### Enable Control

When input voltage is above the under-voltage-lock-out threshold, M0506 can be enabled by pulling the EN pin to above 1.21V and will be disabled if the EN pin is below 1.1V. It is recommended to pull up to  $V_{IN}$  with the resistor about 100k $\Omega$ .

### Power Good Indicator

M0506 has an open drain PG indicator. PG will be pulled up if output voltage is within  $\pm 10\%$  of regulation, otherwise PG is pulled down by internal NMOS. A pull-up resistor to  $V_{IN}$  or  $V_{OUT}$  is needed if used and it is recommended to choose the resistor about 100k $\Omega$ .

### Soft Start Time

The defaulted soft-start time is 6ms. The time can be increased by adding an external capacitor  $C_{SS}$  between SS and AGND.  $C_{SS}$  can be calculated as:

$$C_{SS}(nF) = \frac{T_{SS}(ms) \times 8(\mu A)}{0.6(V)} - 100nF$$

### PCB Layout Guide

To optimize the electrical and thermal performance, some PCB layout guidelines should be considered as below:

1. Use wide trace for the high current paths and keep it as short as possible. It helps to minimize the PCB conduction loss and thermal stress.
2. Place the input coupling capacitor close to VIN and PGND.
3. Connect all feedback network to FB shortly and directly and keep it as close to the Power IC as possible.
4. Keep the SS capacitor and FB network away from the SW.
5. The PGND should be connected to a strong ground plane for better heat dissipation and noise protection.

Figure 1 gives a good example of the recommended layout.

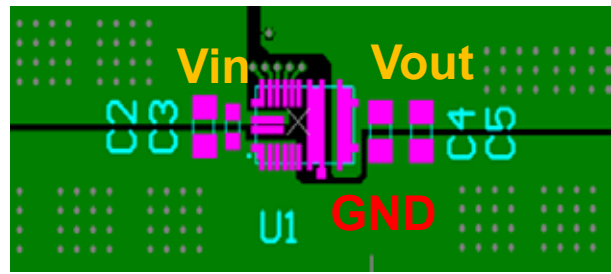

(a) Top Layer

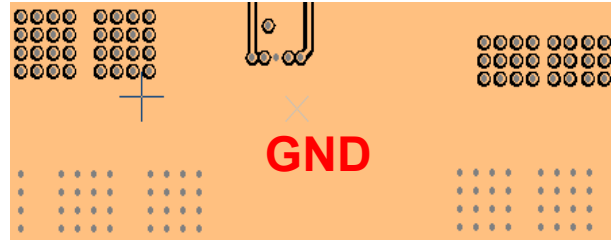

(b) Inner Layer 1

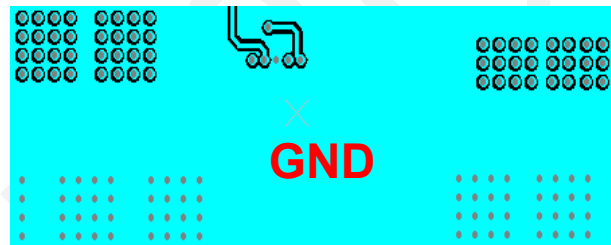

(c) Inner Layer 2

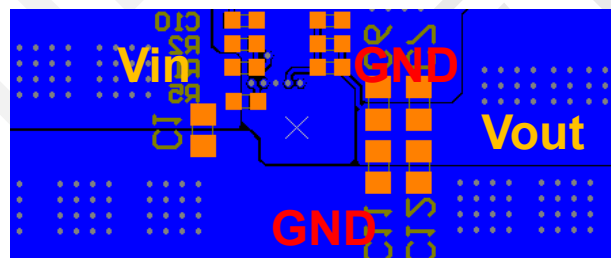

(d) Bottom Layer

Figure 1. Recommended Layout

## TYPICAL APPLICATION

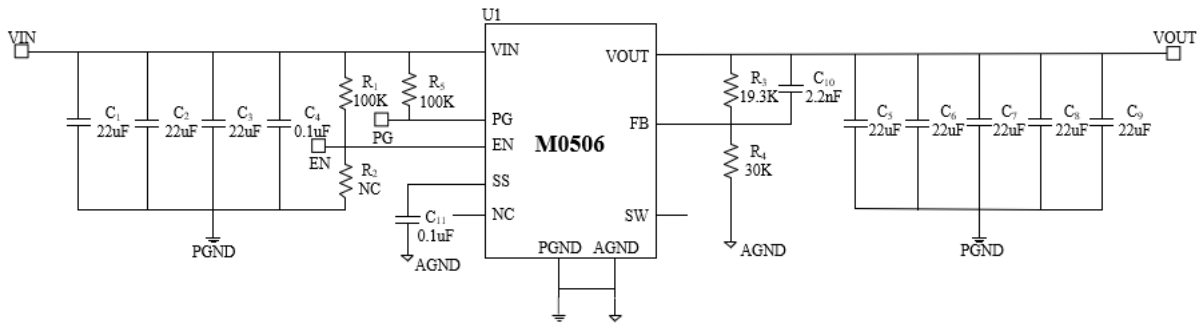

Figure 2. Typical Application Circuits of M0506 for 1V Output

**Table 2: Reference Design**

VOUT	CIN	COUT (Ripple<1%)	C <sub>10</sub>	R <sub>3</sub>	R <sub>4</sub>
3.3V	47uF+3×22uF	5×22uF	2.2nF	133kΩ	30kΩ
1.2V	2×22uF	4×22uF	2.2nF	30kΩ	30.9kΩ
1.0V	2×22uF	4×22uF	2.2nF	19.3kΩ	30kΩ

NOTE:

CIN is the sum of the input capacitors, COUT is the sum of the output capacitors, please refer to Figure 2 for parameters of other components.

**PACKAGE INFORMATION**

LGA-24 (4.0mm×6.0mm×1.82mm) Package

TOP VIEW

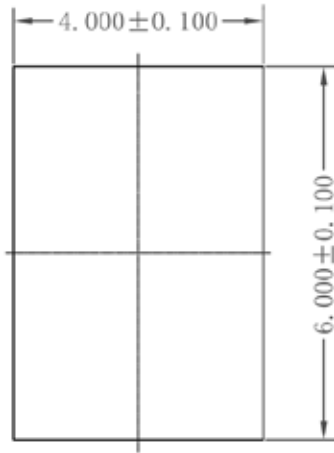

SIDE VIEW

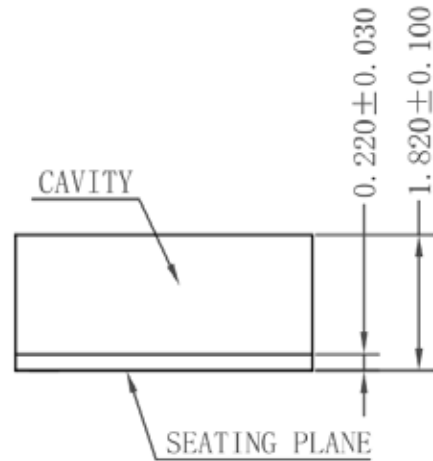

BOTTOM VIEW

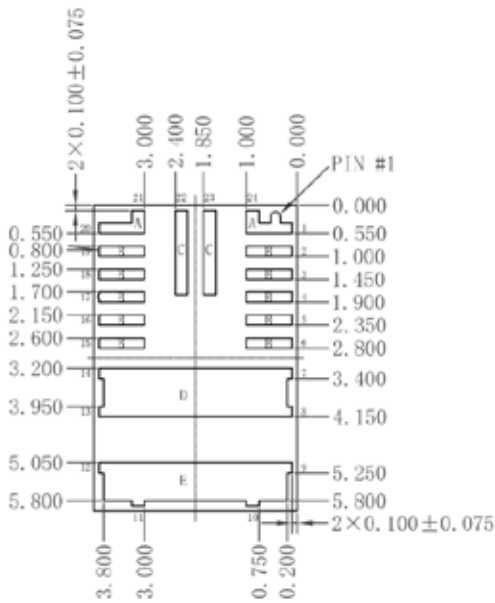

RECOMMENDED LAND PATTERN

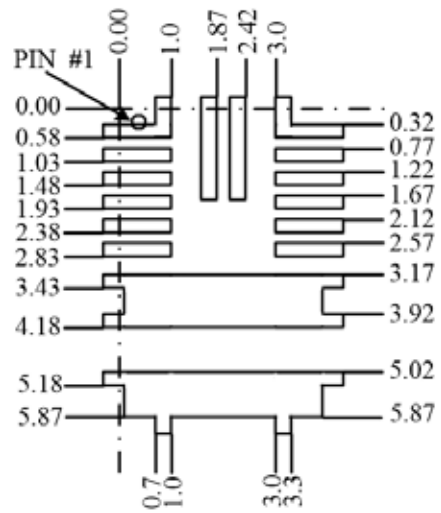

**NOTE:**

All dimensions are in MM.

**CARRIER INFORMATION**

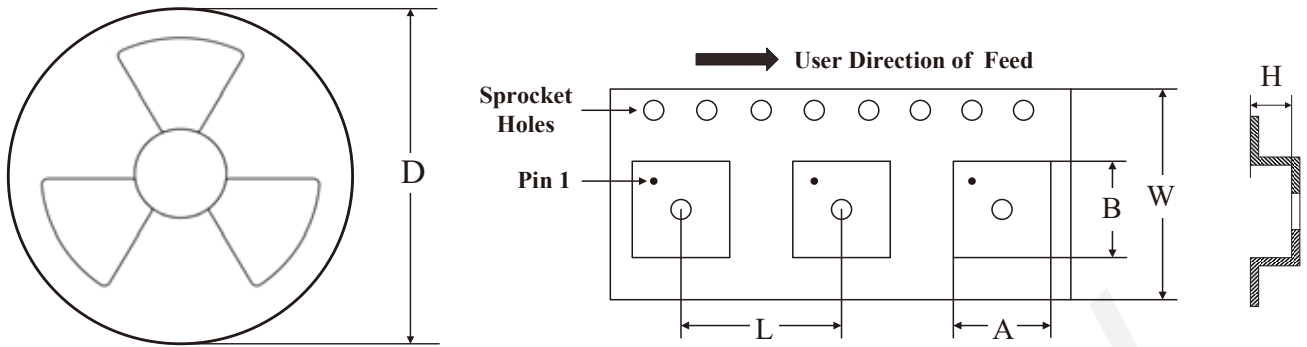

Part Number	Package	Quantity /Reel	D	A	B	L	W	H
M0506DLDD	LGA-24 (4.0mm×6.0mm×1.82mm)	1500	13 in	4.3mm	6.3mm	12mm	16mm	2.12mm