

PRODUCT NO.	1 2 3 4 5 6
DSHP02TJGET	RoHS compliant

REV.	ECN NO.	DR	DATE

NOTES :1.Specification:

- 1>.Operating force:1000gf Max
- 2>.Operating Temperature:-40° to+85°
- 3>.Storage Temperature: -40° to+85°
- 4>.Electrical life Life:2000cycles 25mA 24VDC
- 5>.Mechanical Life:3000cycles Operations

2. PLATING:

GOLD FLASH 1u"~2u" SOLDERTAIL,
1u"~3u" GOLD PLATING ON THE CONTACT AREA,
WITH 50u" NICKEL UNDERPLATING OVERALL.

3. PART NUMBER DESCRIPTION :

DSHP XX T J G E T

- [包装方式: T=管装 R=Reel]
- [电镀层: E=接触部 1u"~3u" 焊脚部 1u"~2u"]
- [G= 镀全金 S= 内镀金(接触部)外镀锡(焊脚部)]
- [脚型: S脚 / J脚 / H脚 / A脚 / Z脚]
- [T= 低推贴胶 S= 低推不贴胶 L=长推]
- [产品数: 02=2P 04=4P 08=8P 10=10P]

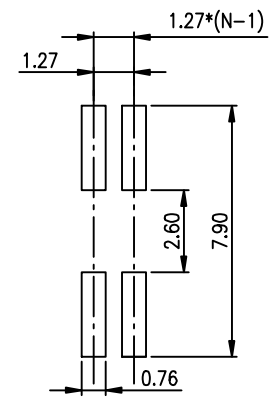
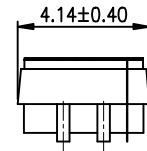
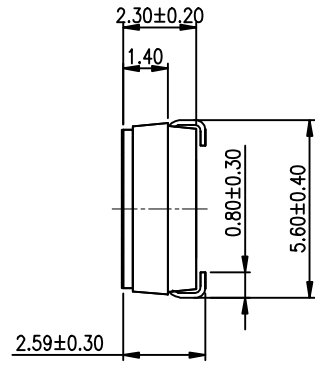
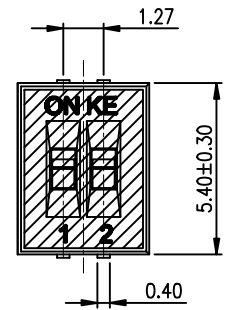

[Schematic]

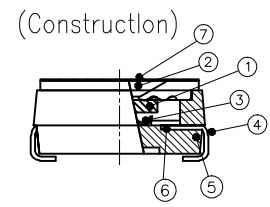
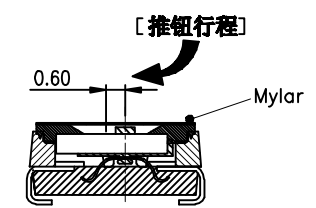
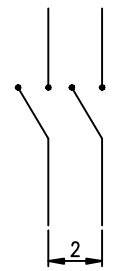

RECOMMENDED P.C.B. LAYOUT (TOP VIEW)

Number	Part Name	Material	Finished
①	Actuator	UL94 V0	White
②	Cover	UL94 V0	Black
③	Movable	Beryllium Copper	1u"~3u" Gold
④	Terminal	Brass	1u"~2u" Gold
⑤	Base	UL94 V0	Black
⑥	Terminal Contact	Brass	1u"~3u" Gold
⑦	Mylar	UL94 V0	0.05mm

TOLERANCE UNLESS OTHERWISE SPECIFIED	INSPECTION COPY
LINER	ANGLES
.0 ± 0.25	0. ± 2'
.00 ± 0.15	.0 ± 1'
.000± 0.10	.00± 0.5'
DESIGN	PROJECTION
kathy	03/20/12'
DRAWING	
CHECK	
APPRO.	

TITLE BY DSHP SERIES PITCH 1.27mm			
PRODUCT FAMILY DSHP SERIES			
PRAT NO. DSHP02TJGET			
FILE NO. DSHP02TJGET-A			
SIZE	UNIT	SCALE	SHEET
A4	mm	2 : 1	1 OF 1
REV.			
A			