



## Features

- Ultra small package: 1.0x0.6x0.5mm
- Ultra low capacitance: 15pF typical
- Ultra low leakage: nA level
- Low operating voltage: 5V
- Low clamping voltage
- 2-pin leadless package
- Complies with following standards:
  - IEC 61000-4-2 (ESD) immunity test
    - Air discharge:  $\pm 30\text{kV}$
    - Contact discharge:  $\pm 30\text{kV}$
  - IEC61000-4-5 (Lightning) 6A (8/20 $\mu\text{s}$ )
- RoHS Compliant

## Applications

- Cellular Handsets and Accessories
- Personal Digital Assistants
- Notebooks and Handhelds
- Portable Instrumentation
- Digital Cameras
- Peripherals
- Audio Players
- Keypads, Side Keys, LCD Displays

## Mechanical Characteristics

- Package: DFN1006
- Lead Finish: Lead Free
- UL Flammability Classification Rating 94V-0
- Quantity Per Reel: 10,000pcs
- Reel Size: 7 inch

## Absolute Maximum Ratings (T<sub>amb</sub>=25°C unless otherwise specified)

Parameter	Symbol	Value	Unit
Peak Pulse Power (8/20 $\mu\text{s}$ )	P <sub>pp</sub>	80	W
ESD per IEC 61000-4-2 (Air)	V <sub>ESD</sub>	$\pm 30$	Kv
ESD per IEC 61000-4-2 (Contact)		$\pm 30$	
Operating Temperature Range	T <sub>J</sub>	-55 to +125	°C
Storage Temperature Range	T <sub>STJ</sub>	-55 to +150	°C

## Dimensions DFN1006

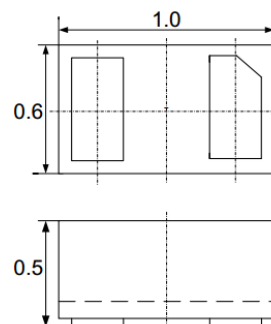

## Pin Configuration

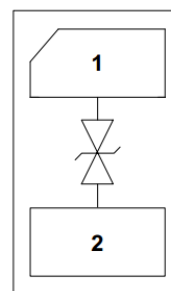

**Electrical Characteristics** (TA=25°C unless otherwise specified)

Part Number	Device Marking	V <sub>RWM</sub> (V)	V <sub>BR</sub> (V)	I <sub>T</sub> (mA)	V <sub>C</sub> @1A	V <sub>C</sub>		I <sub>R</sub> μA (Max)	C (Pf) (Typ.)
						(Max)	(@A)		
ESD5451N-2	B2	5	6	1	7.5	12.5	6	0.5	15

Typical Performance Characteristics ( $T_A=25^\circ\text{C}$  unless otherwise Specified)



Junction Capacitance vs. Reverse Voltage



Clamping Voltage vs. Peak Pulse Current

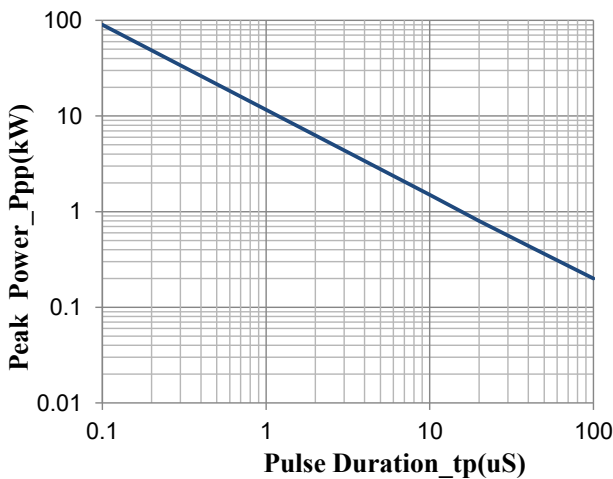

Peak Pulse Power vs. Pulse Time

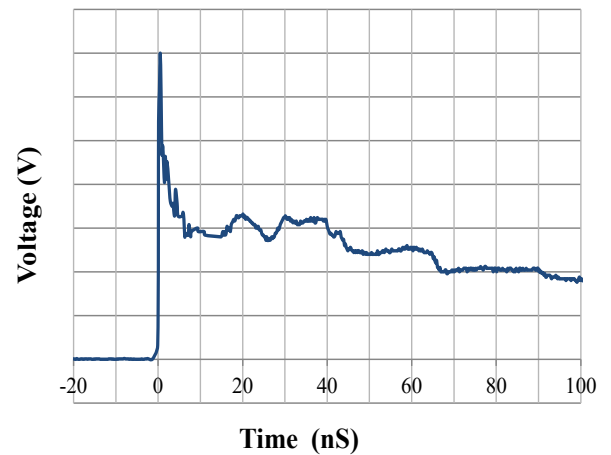

IEC61000-4-2 Pulse Waveform

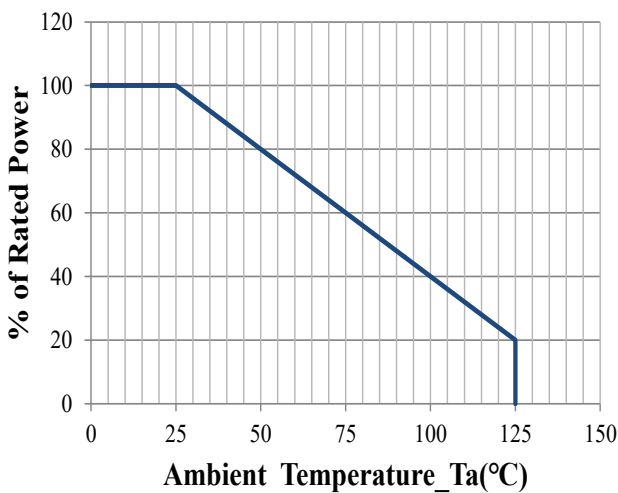

Power Derating Curve

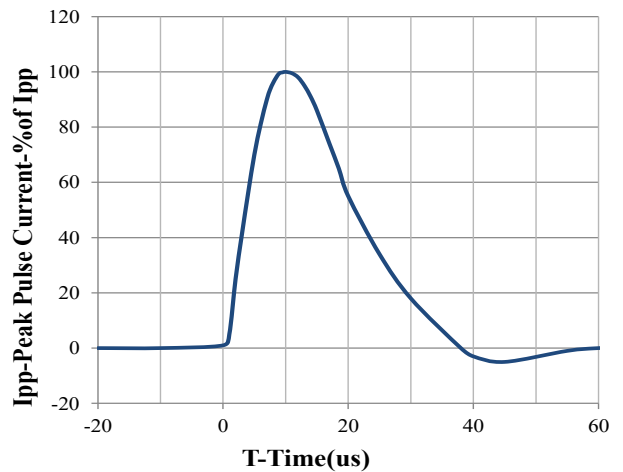

8 X 20us Pulse Waveform



DFN1006 Package Outline Drawing

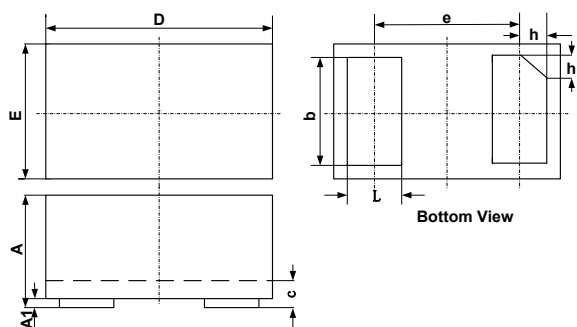

SYM	DIMENSIONS					
	MILLIMETERS			INCHES		
	MIN	NOM	MAX	MIN	NOM	MAX
A	0.45	0.50	0.55	0.018	0.020	0.022
A1	0.00	0.02	0.05	0.000	0.001	0.002
b	0.45	0.50	0.55	0.018	0.020	0.022
c	0.12	0.15	0.18	0.005	0.006	0.007
D	0.95	1.00	1.05	0.037	0.039	0.041
e	0.65 BSC			0.026 BSC		
E	0.55	0.60	0.65	0.022	0.024	0.026
L	0.20	0.25	0.30	0.008	0.010	0.012
h	0.07	0.12	0.17	0.003	0.005	0.007

Suggested Land Pattern

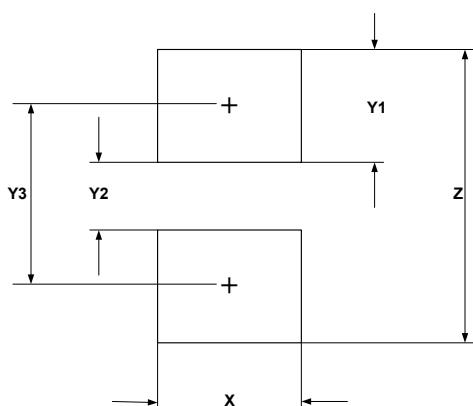

SYM	DIMENSIONS	
	MILLIMETERS	INCHES
X	0.60	0.024
Y1	0.50	0.020
Y2	0.30	0.012
Y3	0.80	0.032
Z	1.30	0.052