



Features

- Ultra small package: 1.0x0.6x0.5mm
- Ultra low capacitance: 15pF typical
- Ultra low leakage: nA level
- Low operating voltage: 5V
- Low clamping voltage
- 2-pin leadless package
- Complies with following standards:
 - IEC 61000-4-2 (ESD) immunity test
 - Air discharge: $\pm 30\text{kV}$
 - Contact discharge: $\pm 30\text{kV}$
 - IEC61000-4-5 (Lightning) 6A (8/20 μs)
- RoHS Compliant

Applications

- Cellular Handsets and Accessories
- Personal Digital Assistants
- Notebooks and Handhelds
- Portable Instrumentation
- Digital Cameras
- Peripherals
- Audio Players
- Keypads, Side Keys, LCD Displays

Mechanical Characteristics

- Package: DFN1006
- Lead Finish: Lead Free
- UL Flammability Classification Rating 94V-0
- Quantity Per Reel: 10,000pcs
- Reel Size: 7 inch

Absolute Maximum Ratings (T_{amb}=25°C unless otherwise specified)

| Parameter | Symbol | Value | Unit |
|--|------------------|-------------|------|
| Peak Pulse Power (8/20 μs) | P _{pp} | 80 | W |
| ESD per IEC 61000-4-2 (Air) | V _{ESD} | ± 30 | Kv |
| ESD per IEC 61000-4-2 (Contact) | | ± 30 | |
| Operating Temperature Range | T _J | -55 to +125 | °C |
| Storage Temperature Range | T _{STJ} | -55 to +150 | °C |

Dimensions DFN1006

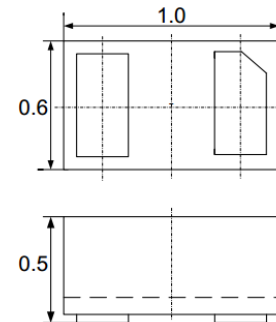

Pin Configuration

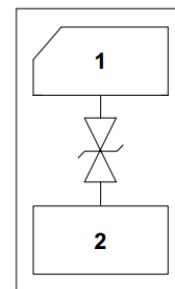

**Electrical Characteristics** (TA=25°C unless otherwise specified)

| Part Number | Device Marking | V _{RWM} (V) | V _{BR} (V) | I _T (mA) | V _C @1A | V _C | | I _R μA (Max) | C (Pf) (Typ.) |
|-------------|----------------|-------------------------|------------------------|------------------------|-----------------------|----------------|------|-------------------------------|---------------------|
| | | | | | | (Max) | (@A) | | |
| AZ5725-01F | B2 | 5 | 6 | 1 | 7.5 | 12.5 | 6 | 0.5 | 15 |

Typical Performance Characteristics ($T_A=25^\circ\text{C}$ unless otherwise Specified)

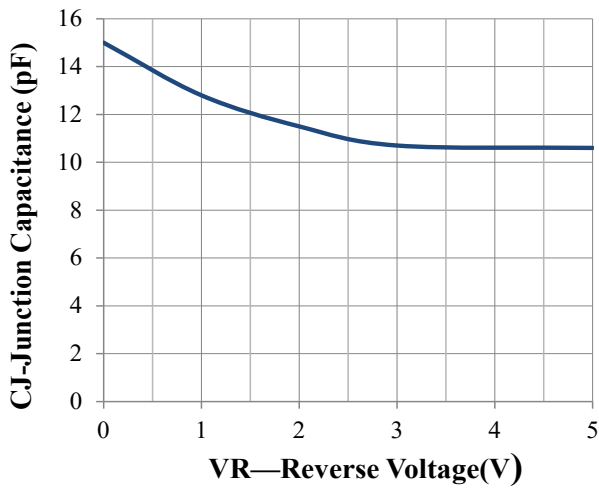

Junction Capacitance vs. Reverse Voltage

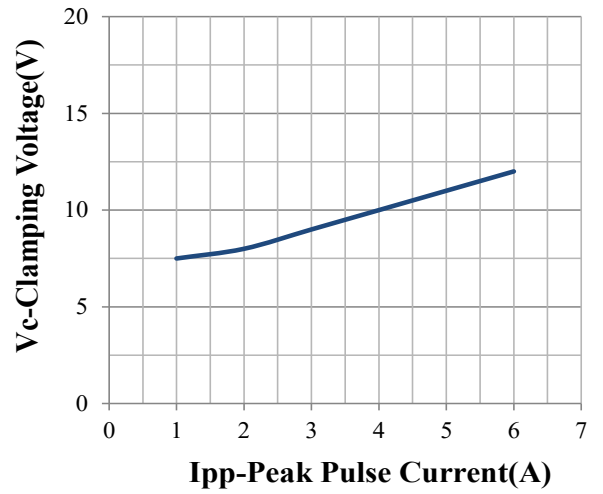

Clamping Voltage vs. Peak Pulse Current

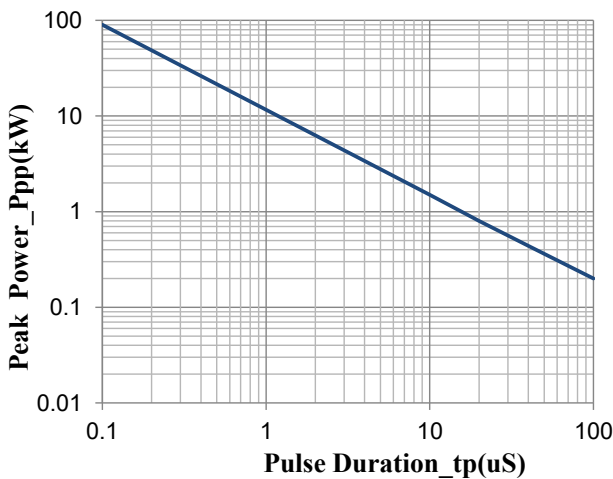

Peak Pulse Power vs. Pulse Time

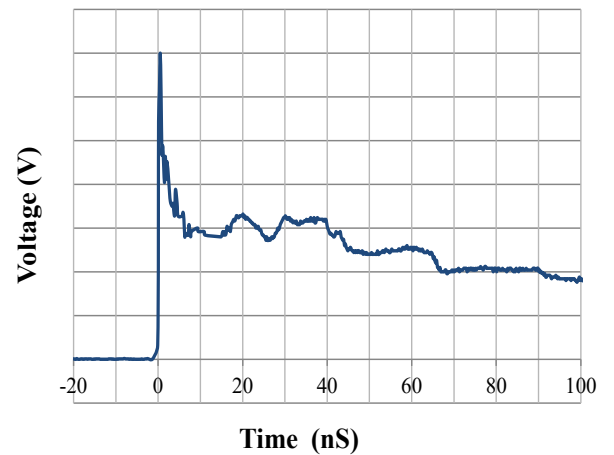

IEC61000-4-2 Pulse Waveform

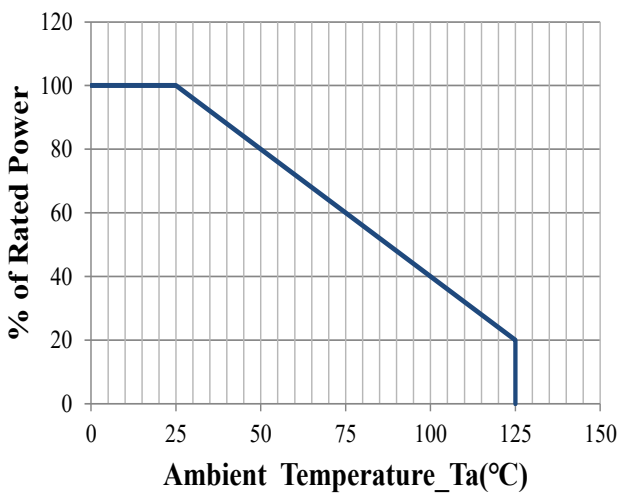

Power Derating Curve

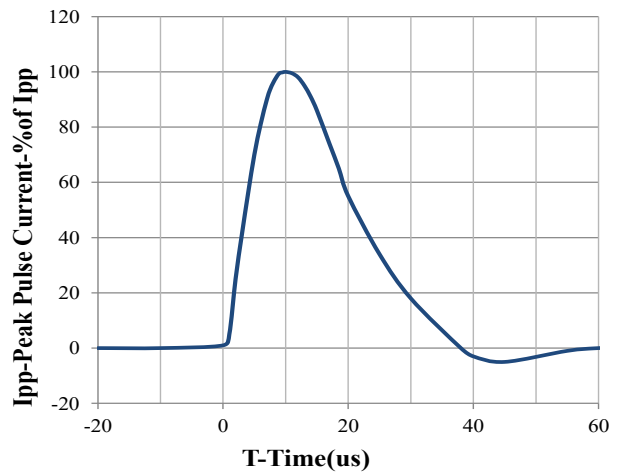

8 X 20us Pulse Waveform

DFN1006 Package Outline Drawing

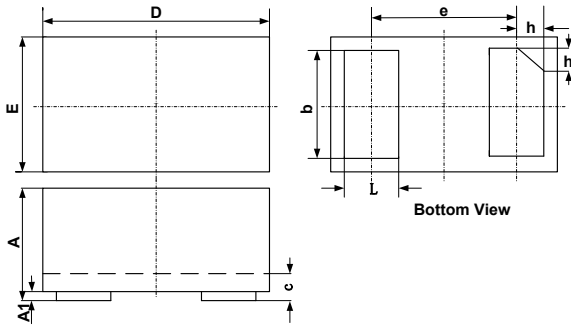

| SYM | DIMENSIONS | | | | | |
|-----|-------------|------|------|-----------|-------|-------|
| | MILLIMETERS | | | INCHES | | |
| | MIN | NOM | MAX | MIN | NOM | MAX |
| A | 0.45 | 0.50 | 0.55 | 0.018 | 0.020 | 0.022 |
| A1 | 0.00 | 0.02 | 0.05 | 0.000 | 0.001 | 0.002 |
| b | 0.45 | 0.50 | 0.55 | 0.018 | 0.020 | 0.022 |
| c | 0.12 | 0.15 | 0.18 | 0.005 | 0.006 | 0.007 |
| D | 0.95 | 1.00 | 1.05 | 0.037 | 0.039 | 0.041 |
| e | 0.65 BSC | | | 0.026 BSC | | |
| E | 0.55 | 0.60 | 0.65 | 0.022 | 0.024 | 0.026 |
| L | 0.20 | 0.25 | 0.30 | 0.008 | 0.010 | 0.012 |
| h | 0.07 | 0.12 | 0.17 | 0.003 | 0.005 | 0.007 |

Suggested Land Pattern

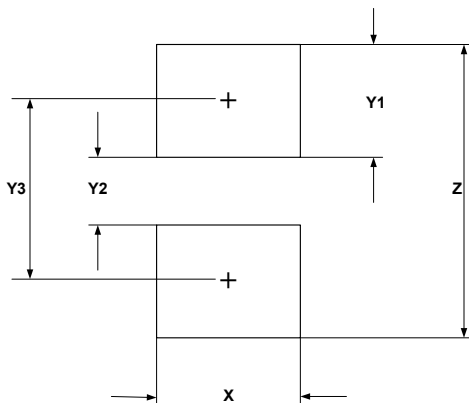

| SYM | DIMENSIONS | |
|-----|-------------|--------|
| | MILLIMETERS | INCHES |
| X | 0.60 | 0.024 |
| Y1 | 0.50 | 0.020 |
| Y2 | 0.30 | 0.012 |
| Y3 | 0.80 | 0.032 |
| Z | 1.30 | 0.052 |