

Features

- 70W peak pulse power ($t_p = 8/20\mu s$)
- Tiny DFN0603-2 package
- Bidirectional configurations
- Solid-state silicon-avalanche technology
- Low clamping voltage
- Low leakage current
- IEC 61000-4-2 $\pm 30kV$ contact $\pm 30kV$ air
- IEC 61000-4-4 (EFT) 40A(5/50ns)
- IEC 61000-4-5 (Lightning) 9A(8/20 μs)

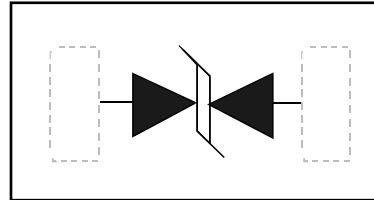

Applications

Cell Phone Handsets and Accessories
 Microprocessor based equipment
 Personal Digital Assistants (PDA's)
 Notebooks, Desktops, and Servers
 Portable Instrumentation

Mechanical Data

- DFN0603-2 package
- Molding compound flammability rating:
UL 94V-0
- Packaging: Tape and Reel
- RoHS/WEEE Compliant

Absolute Maximum Rating

Rating	Symbol	Value	Units
Peak Pulse Power ($t_p = 8/20\mu s$)	P_{pp}	70	W
Peak Pulse Current ($t_p = 8/20\mu s$) (note1)	I_{pp}	9	A
ESD per IEC 61000-4-2 (Air) ESD per IEC 61000-4-2 (Contact)	V_{ESD}	30 30	kV
Lead Soldering Temperature	T_L	260/10S	$^{\circ}C$
Junction Temperature	T_J	-55 to + 125	$^{\circ}C$
Storage Temperature	T_{stg}	-55 to + 125	$^{\circ}C$

Electrical Characteristics

Parameter	Symbol	Conditions	Min	Typical	Max	Units
Reverse Stand-Off Voltage	V_{RWM}				3.3	V
Reverse Breakdown Voltage	V_{BR}	$I_T=1mA$	3.4	4.0		V
Reverse Leakage Current	I_R	$V_{RWM}=3.3V, T=25^{\circ}C$			0.2	μA
Peak Pulse Current	I_{PP}	$t_p=8/20\mu s$			9	A
Clamping Voltage ¹⁾	V_{CL}	$I_{PF}=16A, t_p=100ns$		8		V
Clamping Voltage ²⁾	V_C	$I_{PF}=1A, t_p=8/20\mu s$		5		V
Clamping Voltage ²⁾		$I_{PF}=9A, t_p=8/20\mu s$		8	13	V
Junction Capacitance	C_j	$V_R = 0V, f = 1MHz$		12	17	pF

Electrical Parameters (TA = 25°C unless otherwise noted)

Symbol	Parameter
I_{PP}	Maximum Reverse Peak Pulse Current
V_C	Clamping Voltage @ I_{PP}
V_{RWM}	Working Peak Reverse Voltage
I_R	Maximum Reverse Leakage Current @ V_{RWM}
V_{BR}	Breakdown Voltage @ I_T
I_T	Test Current

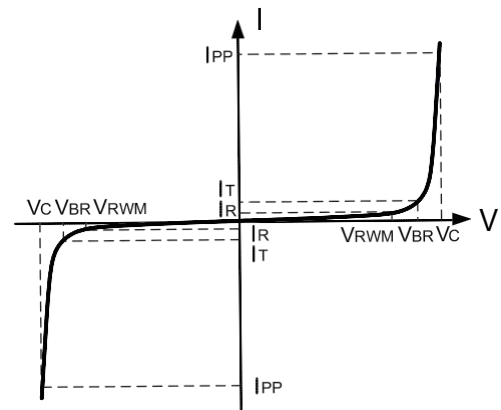

Note: 8/20 μs pulse waveform.

Typical Characteristics

Figure 1: Peak Pulse Power vs. Pulse Time

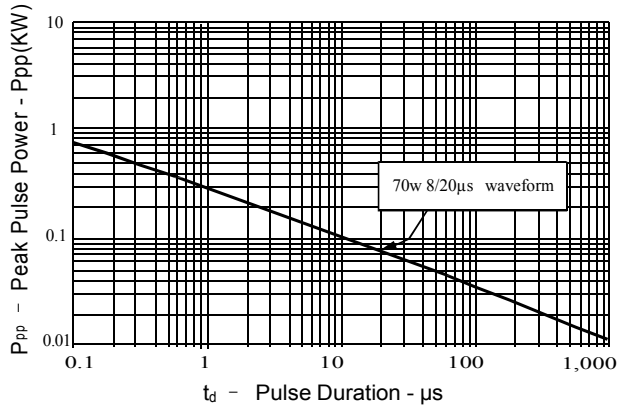

Figure 2: Power Derating Curve

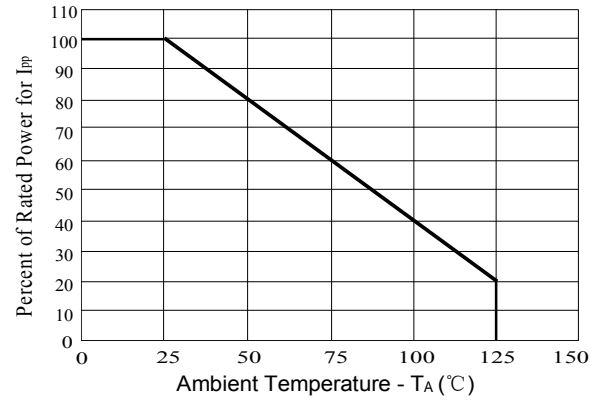

Figure 3: Pulse Waveform

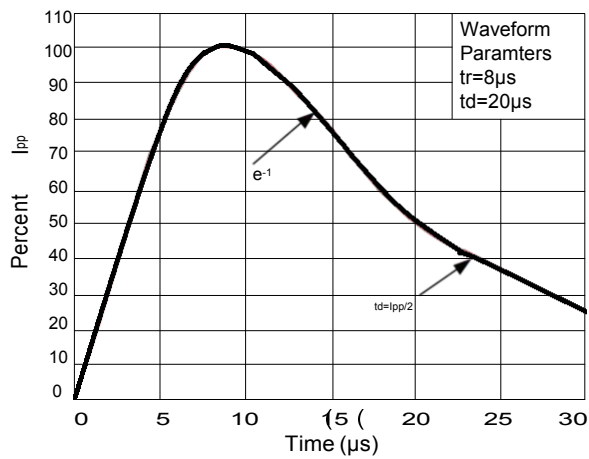
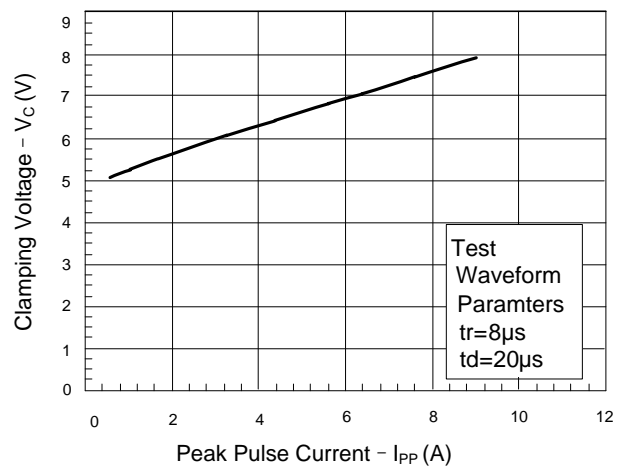
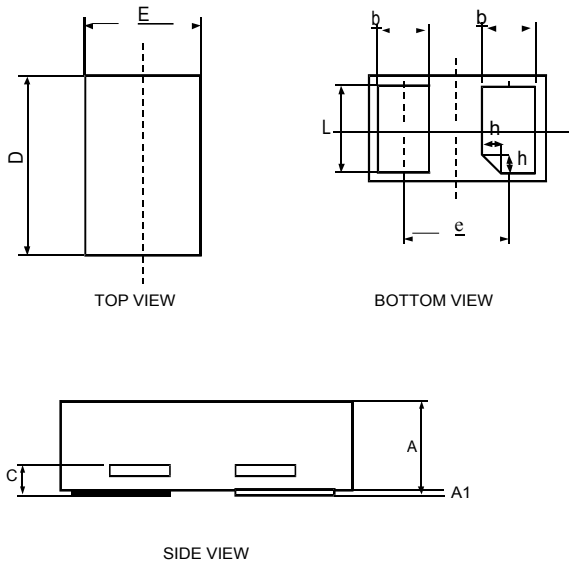

Figure 4: Clamping Voltage vs. Ipp



Outline Drawing –DFN0603-2



Symbol	Dimensions in millimeters		
	Min	Nom	Max
A	0.28	0.30	0.32
A1	0.00	0.02	0.05
C	0.05	0.10	0.15
D	0.55	0.60	0.65
E	0.25	0.30	0.35
e	0.34	0.35	0.37
b	0.14	0.19	0.24
L	0.20	0.25	0.30
h	0	0.05	0.10

Marking

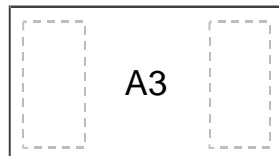

Ordering information

Order code	Package	Baseqty	Delivery mode
UMW PESD3V3V1BCSF	DFN0603-2	10000	Tape and reel