

SMD Power Inductor

CDRH127



Recommended Type

Description

- Ferrite drum core construction
- Magnetically shielded
- LxWxH: 12.3x12.3x8.0 mm Max.
- Product weight: 3.6g(Ref.)
- Moisture Sensitivity Level: 1
- RoHS compliance



Environmental Data

- Operating Temperature: -40°C to +100°C (including coil's self-temperature rise)
- Storage temperature range: -40°C~+100°C
- Solder reflow temperature: 260 °C peak

Packaging

- Carrier tape and reel packaging
- 13" diameter reel
- 500pcs per reel

Applications

- Ideally used in notebook PC, LCD TV, DVD, game machine, STB, projector etc. as converter inductor

Dimension - [mm]

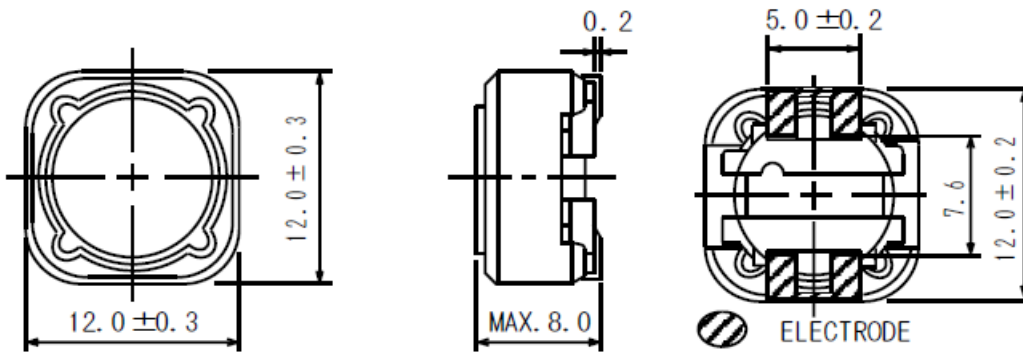

Recommended Land pattern - [mm]

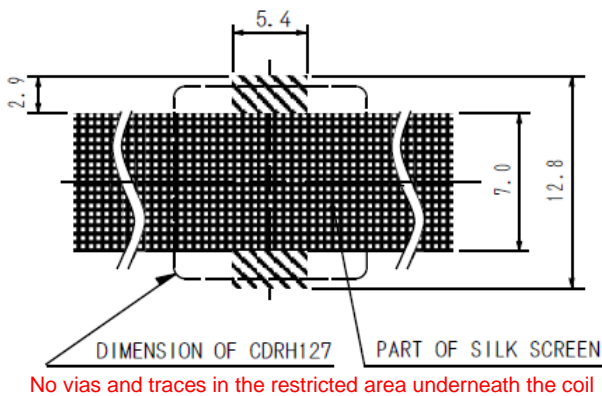

Wire Connection

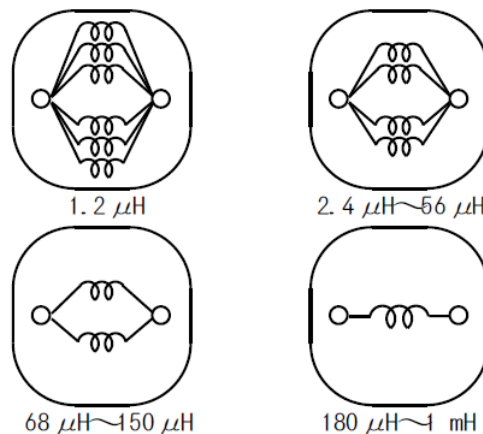

SMD Power Inductor

CDRH127



Electrical Characteristics

| Part Number | Stamp | Inductance [Within] (μ H) ※1 | D.C.R. at 20°C Max. (Typ.) (m Ω) | Saturation Current (A) Max. (Typ.) ※2 | Temperature Rise Current (A) Max. (Typ.) ※3 |
|-----------------|-------|---|--|--|--|
| CDRH127NP-1R2NC | 1R2 | 1.2 μ H \pm 20% | 7.0m (5.2m) | 19.2 (24.0) | 11.30 |
| CDRH127NP-2R4NC | 2R4 | 2.4 μ H \pm 20% | 11.5m (8.5m) | 15.2 (19.0) | 8.90 |
| CDRH127NP-3R5NC | 3R5 | 3.5 μ H \pm 20% | 13.5m (10.0m) | 12.4 (15.5) | 8.40 |
| CDRH127NP-4R7NC | 4R7 | 4.7 μ H \pm 20% | 15.8m (11.7m) | 11.3 (14.2) | 7.80 |
| CDRH127NP-6R1NC | 6R1 | 6.1 μ H \pm 20% | 17.6m (13.0m) | 9.40 (11.8) | 7.20 |
| CDRH127NP-7R6NC | 7R6 | 7.6 μ H \pm 20% | 20.0m (15.0m) | 8.80 (11.0) | 6.50 |
| CDRH127NP-100MC | 100 | 10 μ H \pm 20% | 21.6m (16.0m) | 7.60 (9.50) | 6.30 |
| CDRH127NP-120MC | 120 | 12 μ H \pm 20% | 24.3m (18.0m) | 7.30 (9.20) | 5.80 |
| CDRH127NP-150MC | 150 | 15 μ H \pm 20% | 27.0m (20.0m) | 6.20 (7.80) | 5.50 |
| CDRH127NP-180MC | 180 | 18 μ H \pm 20% | 39.2m (29.0m) | 5.60 (7.10) | 4.90 |
| CDRH127NP-220MC | 220 | 22 μ H \pm 20% | 43.2m (32.0m) | 5.10 (6.40) | 4.40 |
| CDRH127NP-270MC | 270 | 27 μ H \pm 20% | 45.9m (34.0m) | 4.70 (5.90) | 3.90 |
| CDRH127NP-330MC | 330 | 33 μ H \pm 20% | 64.8m (48.0m) | 4.20 (5.30) | 3.50 |
| CDRH127NP-390MC | 390 | 39 μ H \pm 20% | 72.9m (54.0m) | 4.00 (5.00) | 3.40 |
| CDRH127NP-470MC | 470 | 47 μ H \pm 20% | 0.10 (76.0m) | 3.60 (4.50) | 3.20 |
| CDRH127NP-560MC | 560 | 56 μ H \pm 20% | 0.11 (83.0m) | 3.00 (3.80) | 2.80 |
| CDRH127NP-680MC | 680 | 68 μ H \pm 20% | 0.14 (0.10) | 2.80 (3.50) | 2.50 |
| CDRH127NP-820MC | 820 | 82 μ H \pm 20% | 0.16 (0.12) | 2.56 (3.20) | 2.35 |
| CDRH127NP-101MC | 101 | 100 μ H \pm 20% | 0.22 (0.17) | 2.40 (3.00) | 2.05 |
| CDRH127NP-121MC | 121 | 120 μ H \pm 20% | 0.25 (0.18) | 2.28 (2.85) | 1.95 |
| CDRH127NP-151MC | 151 | 150 μ H \pm 20% | 0.28 (0.21) | 1.96 (2.45) | 1.80 |
| CDRH127NP-181MC | 181 | 180 μ H \pm 20% | 0.35 (0.26) | 1.84 (2.30) | 1.68 |
| CDRH127NP-221MC | 221 | 220 μ H \pm 20% | 0.39 (0.29) | 1.60 (2.00) | 1.55 |
| CDRH127NP-271MC | 271 | 270 μ H \pm 20% | 0.56 (0.42) | 1.48 (1.85) | 1.40 |
| CDRH127NP-331MC | 331 | 330 μ H \pm 20% | 0.64 (0.47) | 1.32 (1.65) | 1.30 |
| CDRH127NP-391MC | 391 | 390 μ H \pm 20% | 0.70 (0.52) | 1.24 (1.55) | 1.20 |
| CDRH127NP-471MC | 471 | 470 μ H \pm 20% | 0.98 (0.73) | 1.12 (1.40) | 1.08 |
| CDRH127NP-561MC | 561 | 560 μ H \pm 20% | 1.07 (0.79) | 1.02 (1.28) | 0.98 |
| CDRH127NP-681MC | 681 | 680 μ H \pm 20% | 1.46 (1.12) | 0.96 (1.20) | 0.82 |

Note: This specification is subject to change without notice. Please contact your nearest sales office for updated information when placing an order.

SMD Power Inductor

CDRH127



Recommended Type

| | | | | | |
|-----------------|-----|-----------------------|-------------|-------------|------|
| CDRH127NP-821MC | 821 | 820 μ H \pm 20% | 1.64 (1.26) | 0.86 (1.08) | 0.75 |
| CDRH127NP-102MC | 102 | 1.0mH \pm 20% | 1.82 (1.40) | 0.77 (0.96) | 0.70 |

※1. Measured frequency: 1.2 μ H ~ 7.6 μ H at 100 kHz; 10 μ H ~ 1mH at 1 kHz

※2. Saturation current: This indicates the value of D.C. current when the inductance becomes 25% lower than its initial value. (Ta = 20°C)

※3. Temperature rise current: The actual value of D.C. current when the temperature of coil becomes $\Delta T=40^\circ\text{C}$ (Ta = 20°C).

Solder Reflow Condition

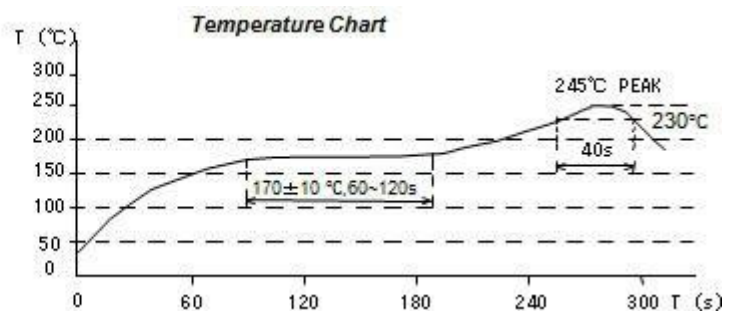
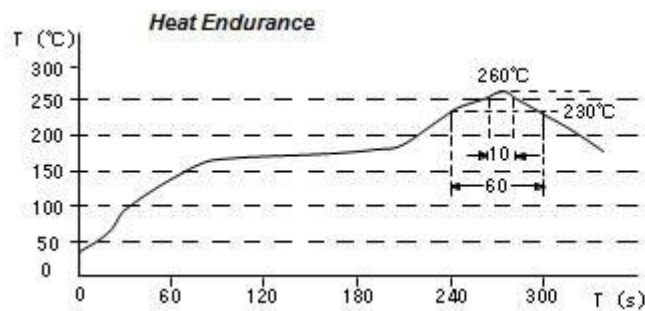

SMD Power Inductor

CDRH127



Saturation Current & Temperature Rise Graph

— L (20°C) — L (100°C) — ΔT

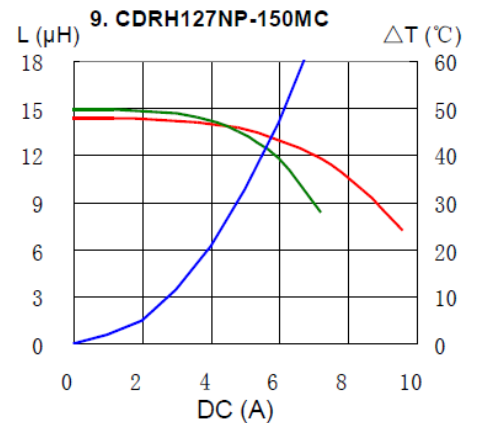
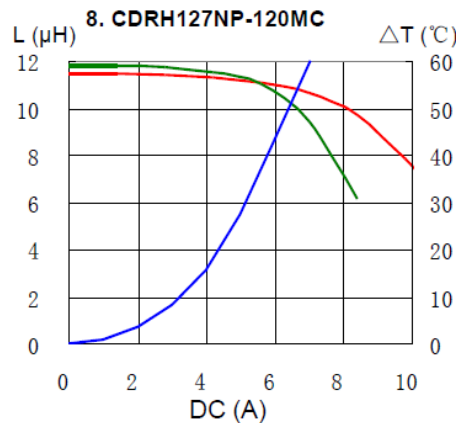
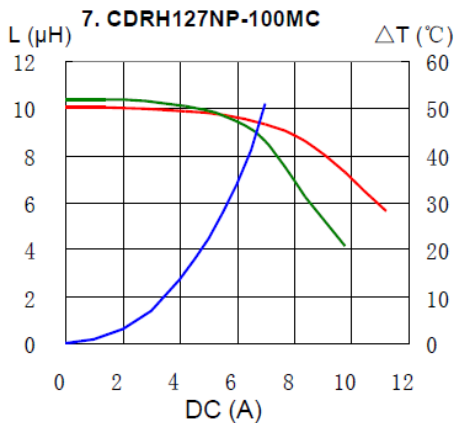
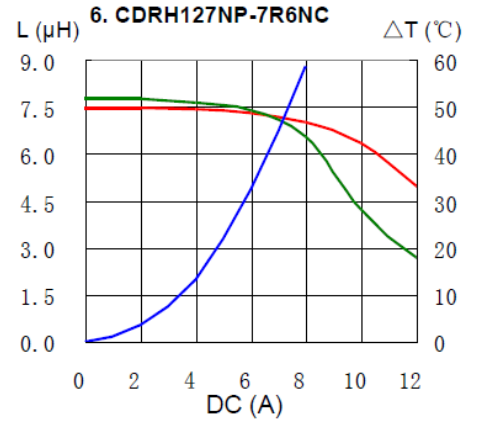
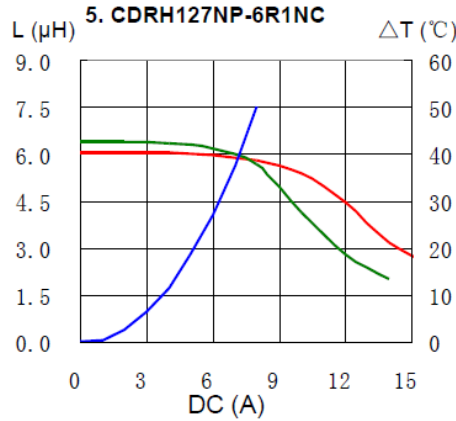
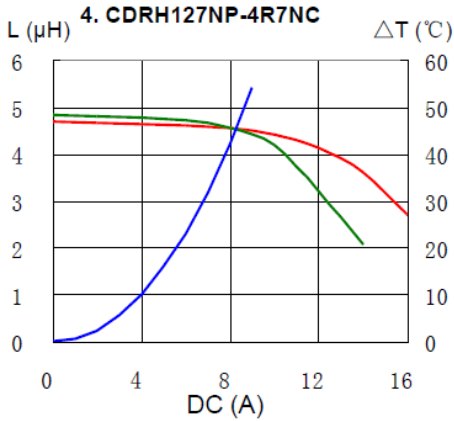
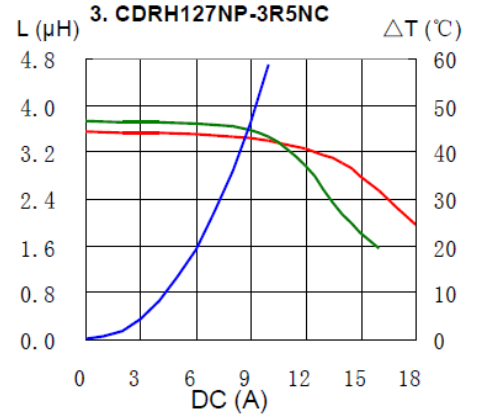
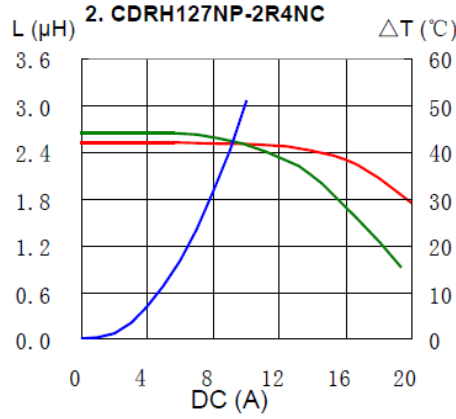
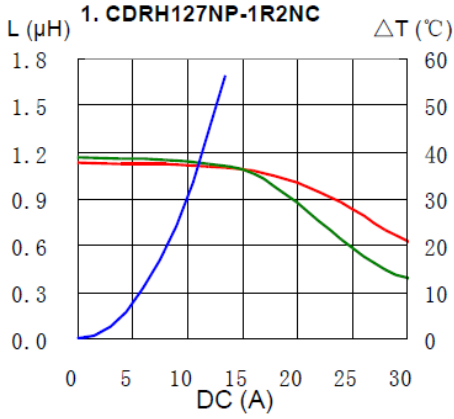

SMD Power Inductor

CDRH127



Recommended Type

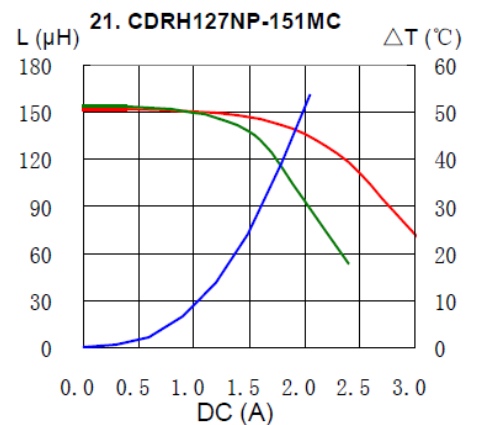
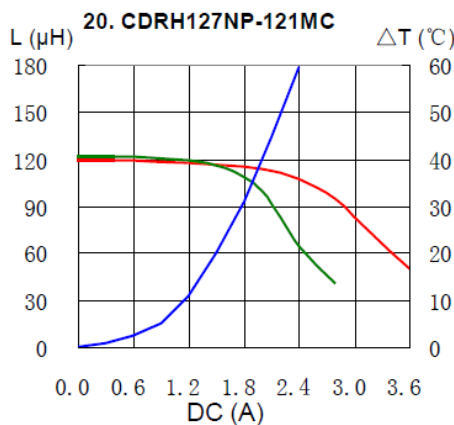
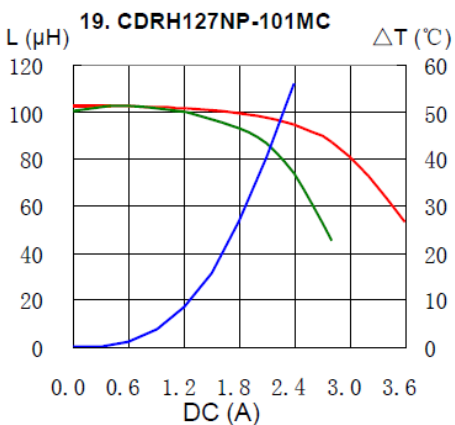
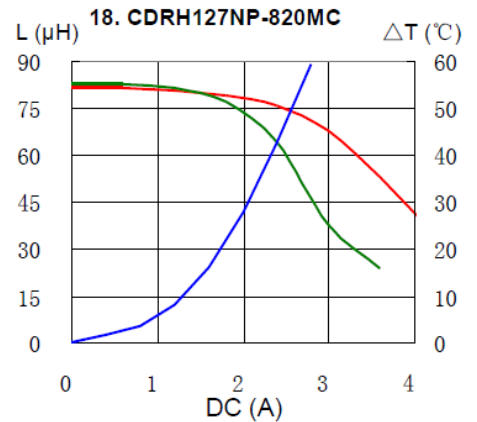
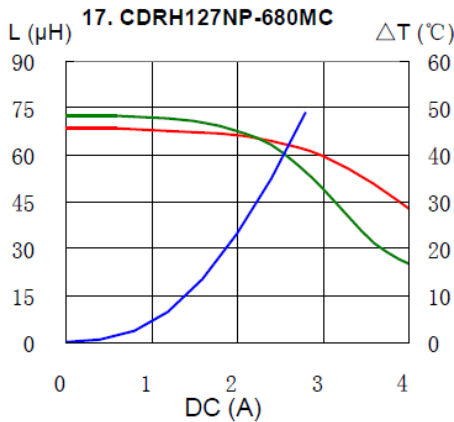
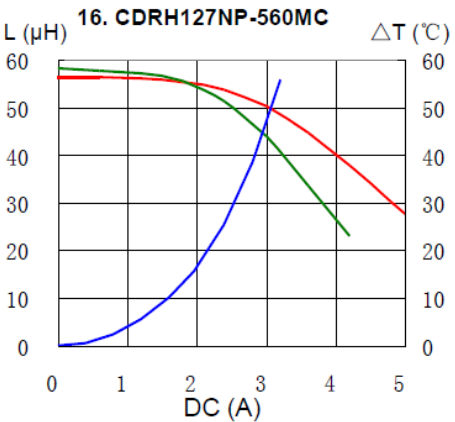
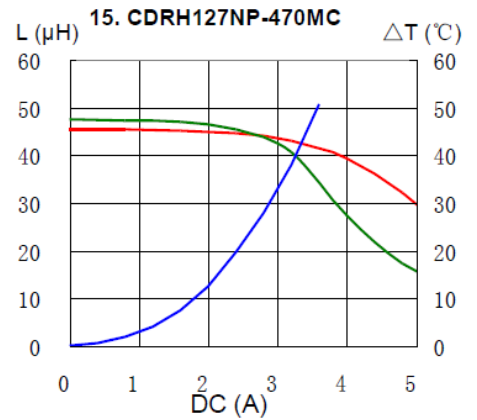
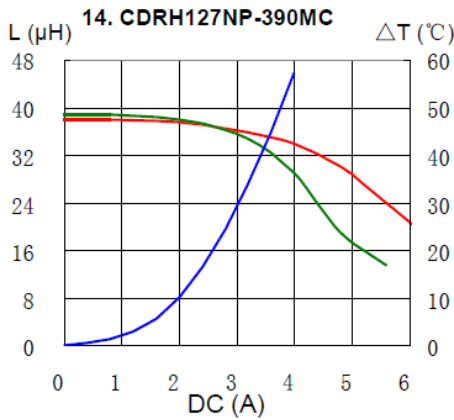
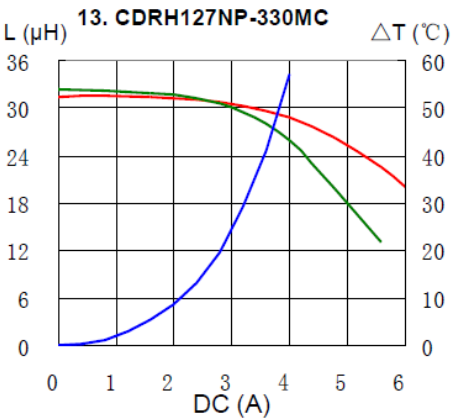
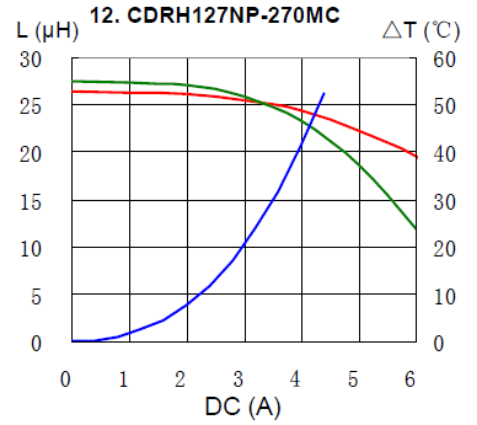
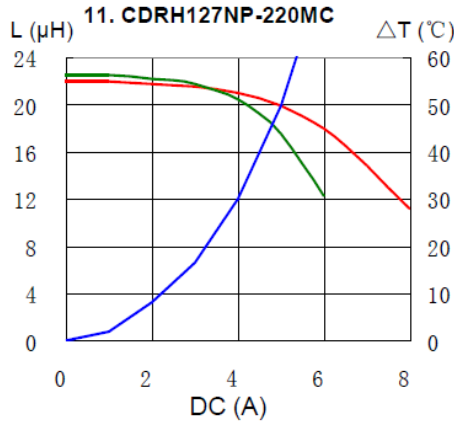
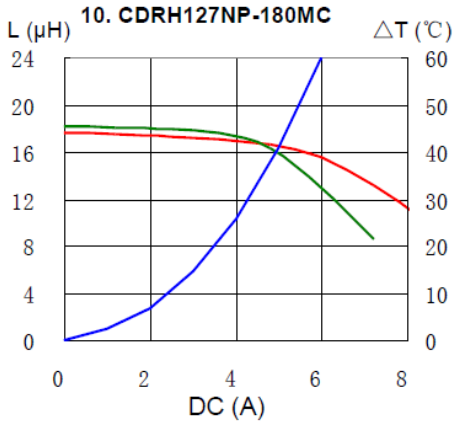

Note: This specification is subject to change without notice. Please contact your nearest sales office for updated information when placing an order.

SMD Power Inductor

CDRH127



Recommended Type

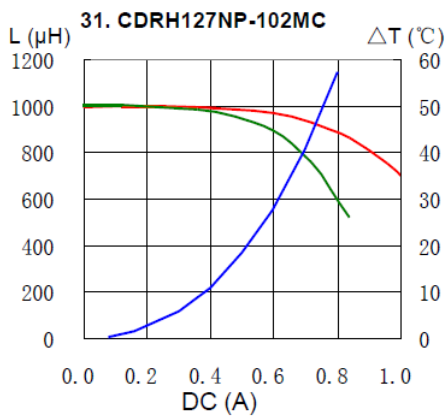
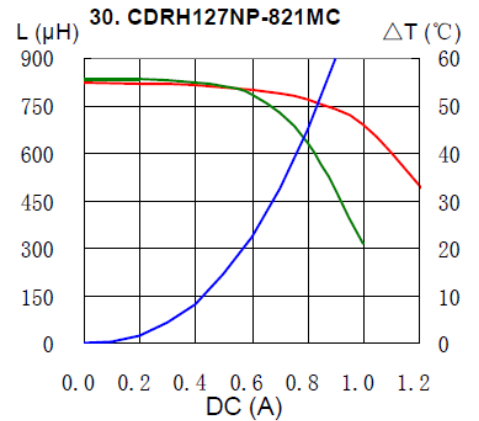
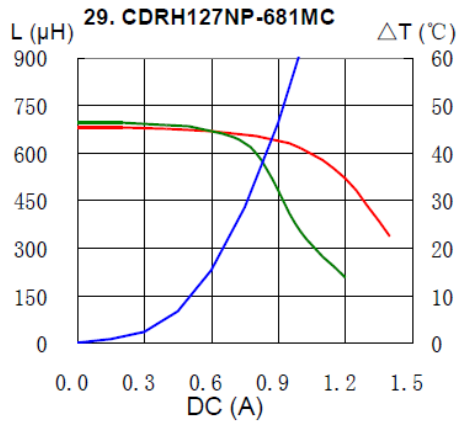
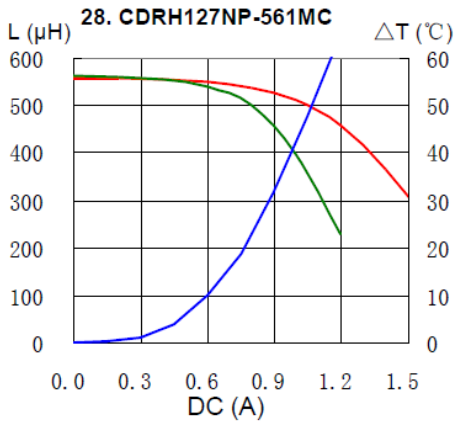
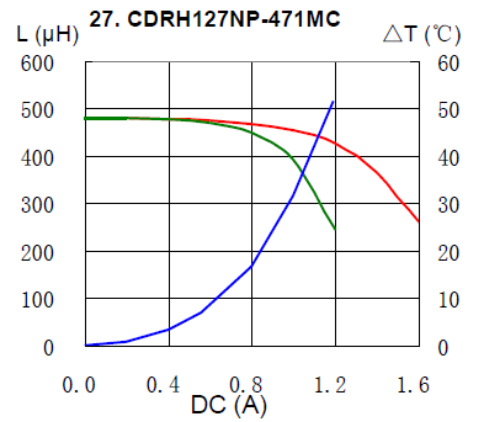
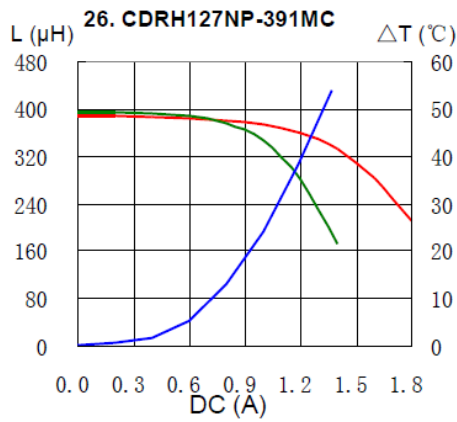
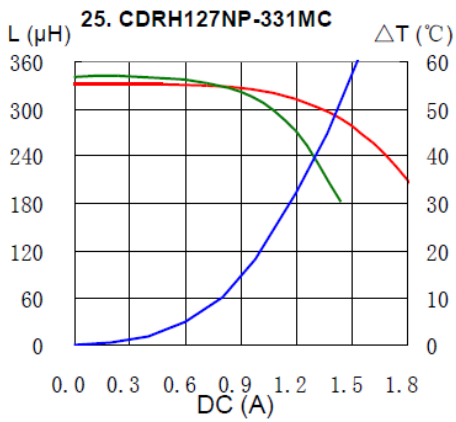
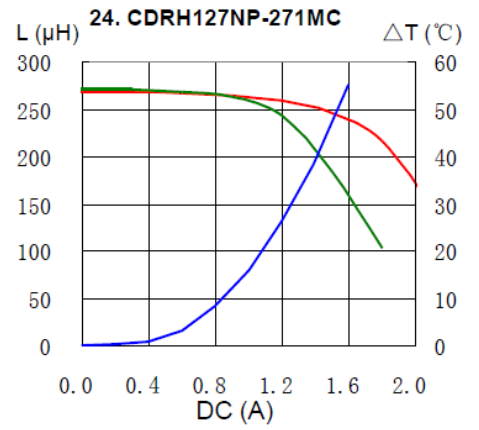
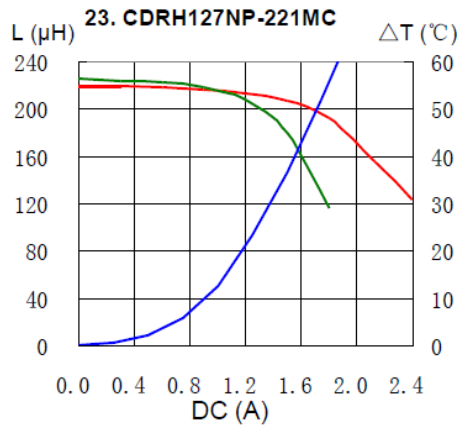
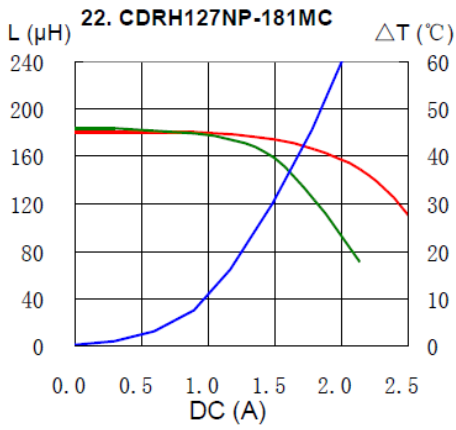

For sales office information, please [click here](#) to visit our website.