

SE30P12

P-Channel Enhancement-Mode MOSFET

Revision: A

General Description

Advanced trench technology to provide excellent $R_{DS(ON)}$, low gate charge and low operation voltage. This device is suitable for using as a load switch or in PWM applications.

- Simple Drive Requirement
- Small Package Outline
- Surface Mount Device

Features

For a single MOSFET

- $V_{DS} = -30V$
- $R_{DS(ON)} = 11.5m\Omega @ V_{GS}=-10V$
- $R_{DS(ON)} = 18m\Omega @ V_{GS}=-4.5V$

Pin configurations

See Diagram below

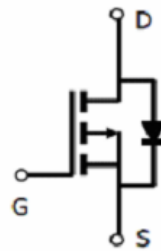
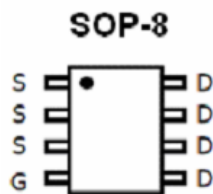

Absolute Maximum Ratings

Parameter		Symbol	Rating	Units
Drain-Source Voltage		V_{DS}	-30	V
Gate-Source Voltage		V_{GS}	± 20	V
Drain Current	Continuous	I_D	-11	A
	Pulsed		-50	
Total Power Dissipation	@TA=25°C	P_D	2	W
Operating Junction Temperature Range		T_J	-55 to 150	°C

SE30P12

Electrical Characteristics (T _J =25°C unless otherwise noted)						
Symbol	Parameter	Test Conditions	Min	Typ	Max	Units
OFF CHARACTERISTICS (Note 2)						
BV _{DSS}	Drain-Source Breakdown Voltage	I _D =-250μA, V _{GS} =0 V	-30	-33		V
I _{DSS}	Drain to Source Leakage Current	V _{DS} = -24V, V _{GS} =0V			-5	μA
I _{GSS}	Gate-Body Leakage Current	V _{GS} = 20V			100	nA
V _{GS(th)}	Gate Threshold Voltage	V _{DS} = V _{GS} , I _D =-250μA	-1	-1.5	-3	V
R _{DS(ON)}	Static Drain-Source On-Resistance ²	V _{GS} =-10V, I _D =-10A	-	11.5	15	mΩ
		V _{GS} =-4.5V, I _D =-7A		18	25	mΩ
DYNAMIC PARAMETERS						
C _{iss}	Input Capacitance	V _{GS} =0V, V _{DS} =-15V, f=1MHz		5270		pF
C _{oss}	Output Capacitance			945		pF
C _{rss}	Reverse Transfer Capacitance			745		pF
SWITCHING PARAMETERS						
Q _g	Total Gate Charge ²	V _{GS} =-10V, V _{DS} =-15V, I _D =-15A		100		nC
Q _{gs}	Gate Source Charge			14.5		nC
Q _{gd}	Gate Drain Charge			23		nC
t _{d(on)}	Turn-On Delay Time	V _{GS} =-10V, V _{DS} =-15V, R _{GEN} =3Ω, R _L =1Ω		14		ns
t _{d(off)}	Turn-Off Delay Time			76.5		ns
t _{d(r)}	Turn-On Rise Time			16.5		ns
t _{d(f)}	Turn-Off Fall Time			37.5		ns
Thermal Resistance						
Symbol	Parameter		Typ	Max	Units	
R _{θJA}	Junction to Ambient (t ≤ 10s)		26	40	°C/W	

Typical Characteristics

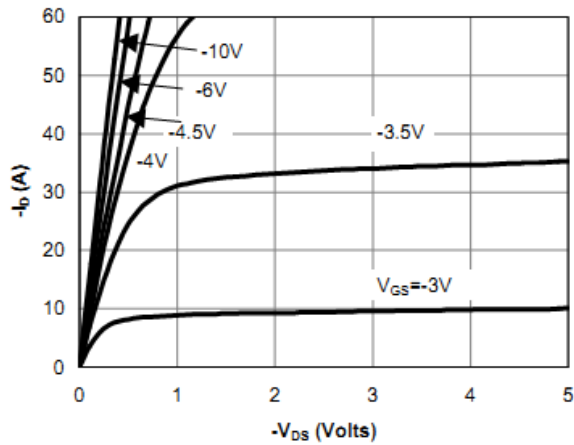

Fig 1: On-Region Characteristics

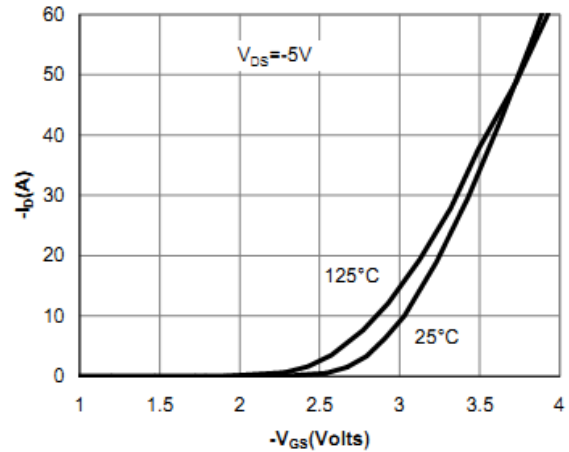

Figure 2: Transfer Characteristics

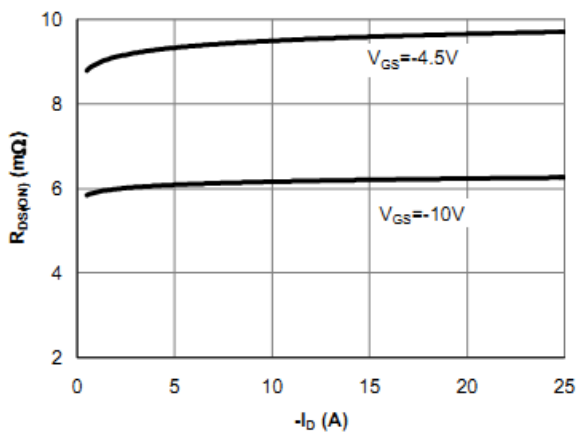

Figure 3: On-Resistance vs. Drain Current and Gate Voltage

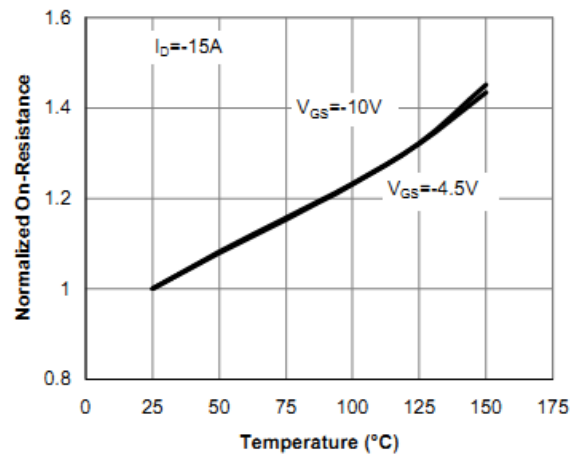

Figure 4: On-Resistance vs. Junction Temperature

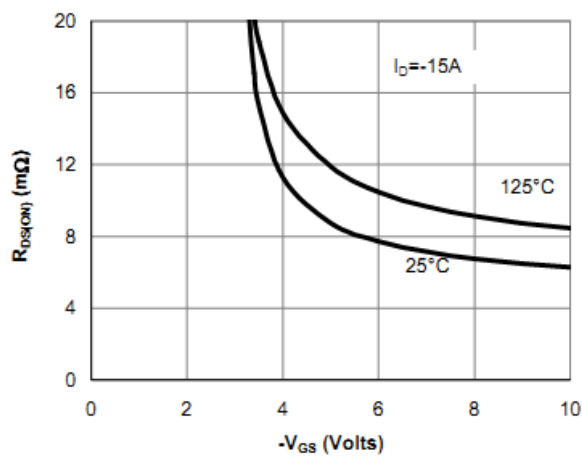

Figure 5: On-Resistance vs. Gate-Source Voltage

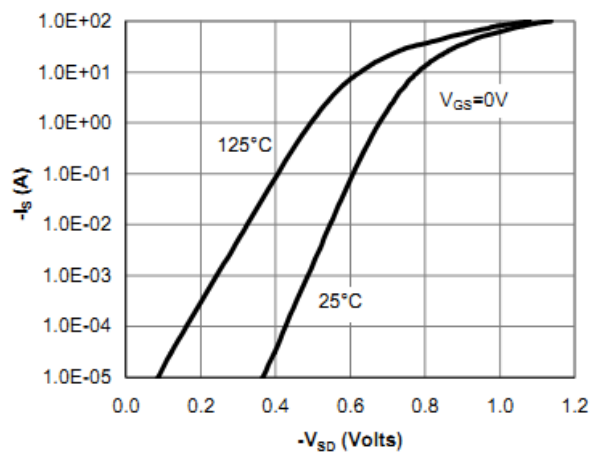

Figure 6: Body-Diode Characteristics

Typical Characteristics

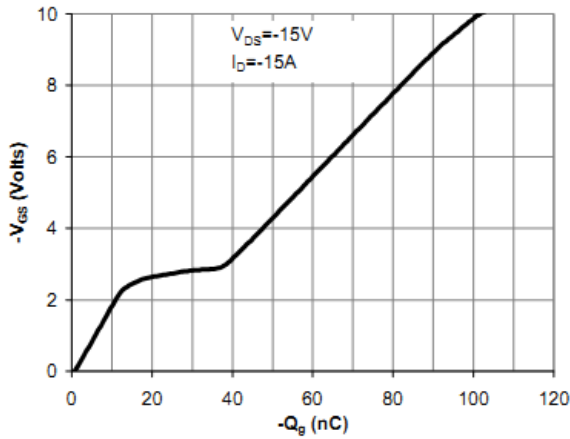

Figure 7: Gate-Charge Characteristics

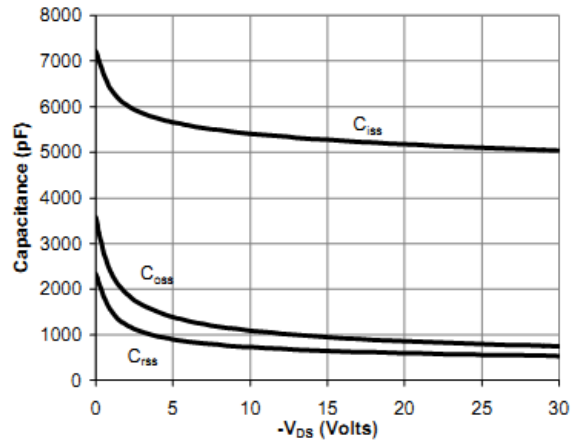

Figure 8: Capacitance Characteristics

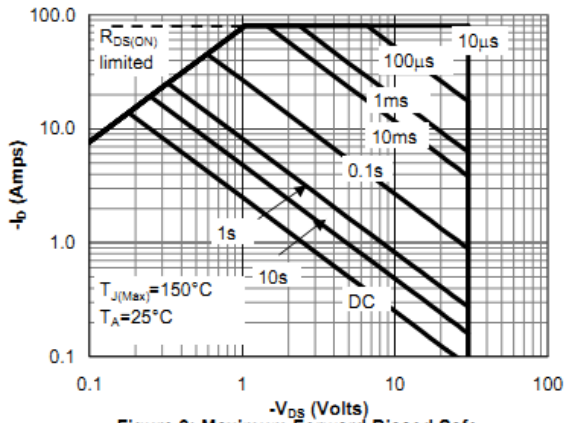

Figure 9: Maximum Forward Biased Safe Operating Area (Note E)

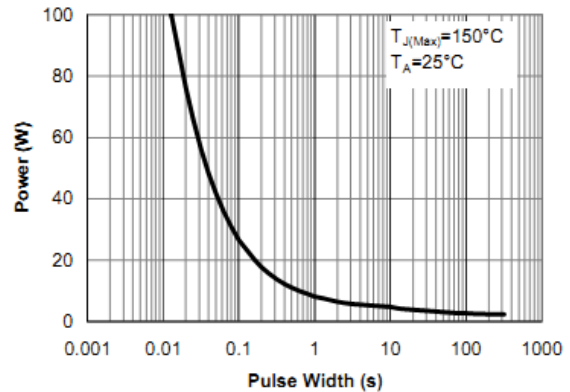

Figure 10: Single Pulse Power Rating Junction-to-Ambient (Note E)

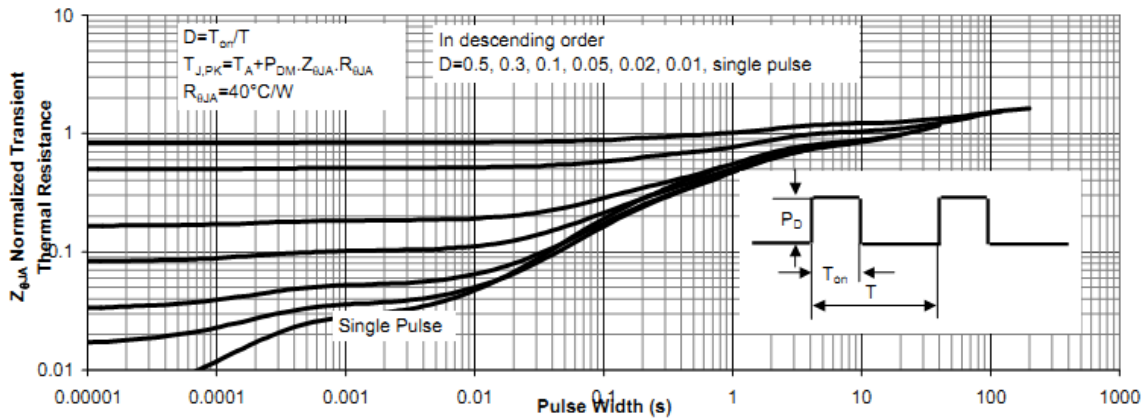
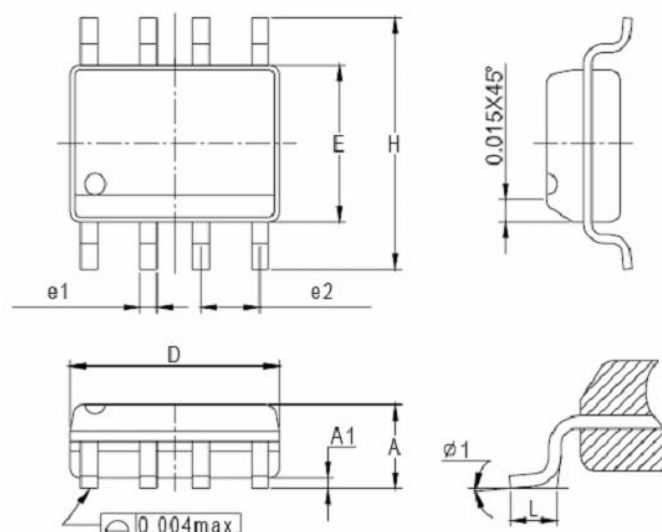

Figure 11: Normalized Maximum Transient Thermal Impedance

SE30P12

Package Outline Dimension

SOP-8



Dim	Millimeters		Inches	
	Min.	Max.	Min.	Max.
A	1.35	1.75	0.053	0.069
A1	0.10	0.25	0.004	0.010
D	4.80	5.00	0.189	0.197
E	3.80	4.00	0.150	0.157
H	5.80	6.20	0.228	0.244
L	0.40	1.27	0.016	0.050
e1	0.33	0.51	0.013	0.020
e2	1.27BSC		0.50BSC	
φ 1	8°		8°	

The SINO-IC logo is a registered trademark of ShangHai Sino-IC Microelectronics Co., Ltd.

© 2005 SINO-IC - Printed in China - All rights reserved.

SHANGHAI SINO-IC MICROELECTRONICS CO., LTD

Add: Building 3, Room 3401-03, No.200 Zhangheng Road,
ZhangJiang Hi-Tech Park, Pudong, Shanghai 201203, China

Phone: +86-21-33932402 33932403

33932405 33933508 33933608

Fax: +86-21-33932401

Email: szrxw002@126.com

Website: <http://www.sino-ic.net>