

SE10060A

N-Channel Enhancement-Mode MOSFET

Revision: A

General Description

Advanced trench technology to provide excellent RDS(ON), low gate charge and low operation voltage. This device is suitable for using as a load switch or in PWM applications.

- Simple Drive Requirement
- Small Package Outline
- Surface Mount Device

Features

For a single MOSFET

- $V_{DS} = 100V$
- $R_{DS(ON)} = 14m\Omega @ V_{GS}=10V$

Pin configurations

See Diagram below

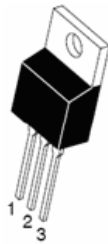

TO-220

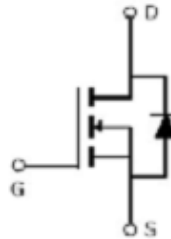

Absolute Maximum Ratings

Parameter	Symbol	Rating	Units
Drain-Source Voltage	V_{DS}	100	V
Gate-Source Voltage	V_{GS}	± 20	V
Drain Current	I_D	Continuous ^{1,2,3}	60
		Pulsed	200
Total Power Dissipation	P_D	170	W
Single-pulse avalanche energy ⁴	E_{AS}	580	mJ
Operating Junction Temperature Range	T_J	-55 to 150	$^{\circ}C$

Thermal Resistance

Symbol	Parameter	Min	Typ	Units
$R_{\theta JA}$	Junction to Ambient		0.88	$^{\circ}C/W$

SE10060A

Electrical Characteristics (T _J =25°C unless otherwise noted)						
Symbol	Parameter	Test Conditions	Min	Typ	Max	Units
OFF CHARACTERISTICS (Note 2)						
B _V DSS	Drain-Source Breakdown Voltage	I _D =250μA, V _{GS} =0 V	100			V
I _{DSS}	Drain to Source Leakage Current	V _{DS} = 100V, V _{GS} =0V			1	μA
I _{GSS}	Gate-Body Leakage Current	V _{GS} =20 V			100	nA
V _{GS(th)}	Gate Threshold Voltage	V _{DS} = V _{GS} , I _D =250μA	2	3	4	V
R _{DS(ON)}	Static Drain-Source On-Resistance	V _{GS} =10V, I _D =40A		14	17	mΩ
g _{FS}	Forward Transconductance	V _{DS} = 25V, I _D =28A	32			S
DYNAMIC PARAMETERS						
C _{iss}	Input Capacitance	V _{GS} =0V, V _{DS} =25V, f=1MHz		3400		pF
C _{oss}	Output Capacitance			260		pF
C _{rss}	Reverse Transfer Capacitance			210		pF
SWITCHING PARAMETERS						
Q _g	Total Gate Charge ²	V _{DD} =30V, V _{GS} =10V, I _D =30A		94		nC
Q _{gs}	Gate Source Charge			16		nC
Q _{gd}	Gate Drain Charge			24		nC
t _{d(on)}	Turn-On Delay Time	V _{DD} =30V, V _{GS} =10V, I _D =2A, R _{GEN} =2.5Ω		15		ns
t _{d(off)}	Turn-Off Delay Time			52		ns
t _{d(r)}	Turn-On Rise Time			11		ns
t _{d(f)}	Turn-Off Fall Time			13		ns
Source-Drain Characteristics						
Symbol	Parameter	Test Condition	Min	Typ	Max	Units
V _{SD}	Diode forward voltage	V _{GS} =0V, I _S =100A		0.85	1.2	V
I _S	Diode forward current				60	A
T _{rr}	Reverse recovery time ⁷	T _J =25°C, I _F =28A di/dt=100A/μs		33		ns
Q _{rr}	Reverse recovery charge ⁷			54		nC

Typical Characteristics

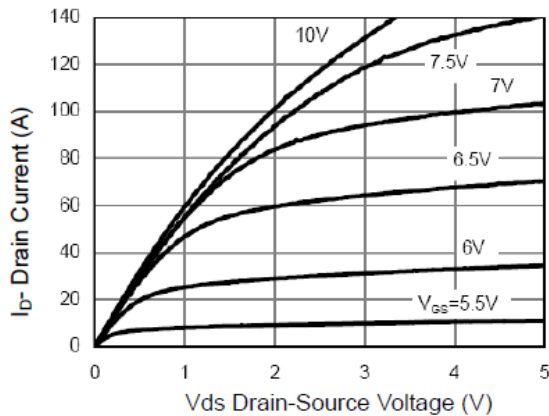

Figure 1 Output Characteristics

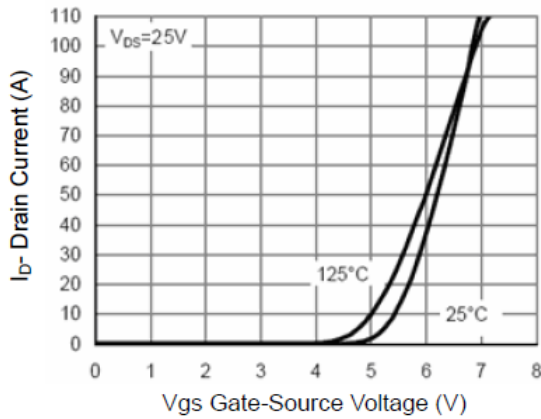

Figure 2 Transfer Characteristics

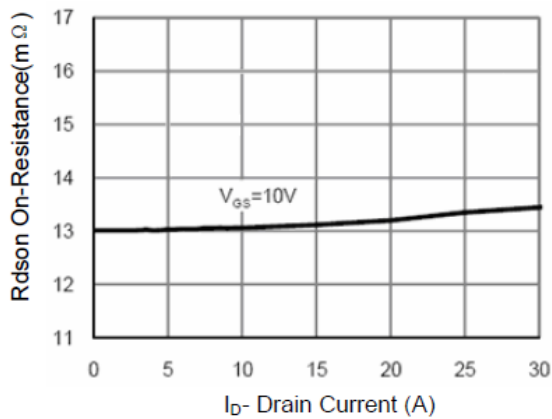

Figure 3 $R_{DS(on)}$ - Drain Current

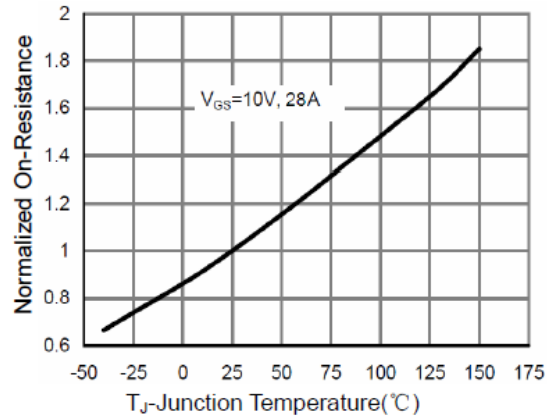

Figure 4 $R_{DS(on)}$ -Junction Temperature

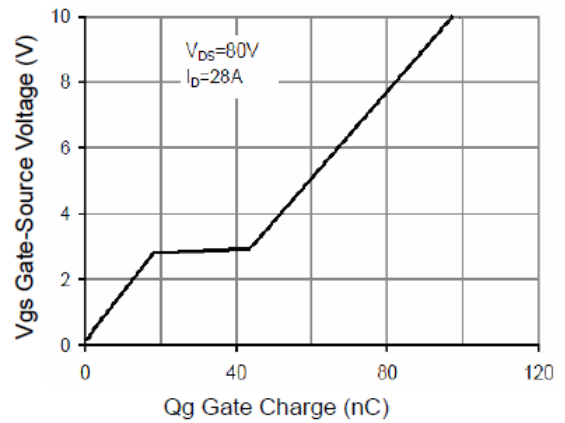

Figure 5 Gate Charge

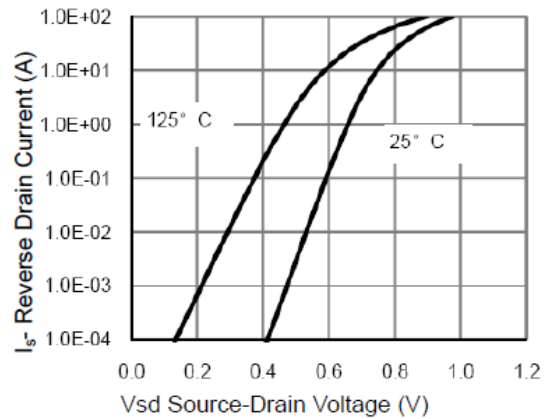

Figure 6 Source- Drain Diode Forward

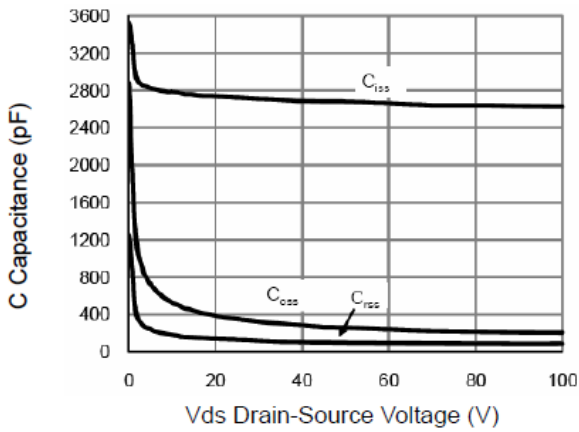

Figure 7 Capacitance vs Vds

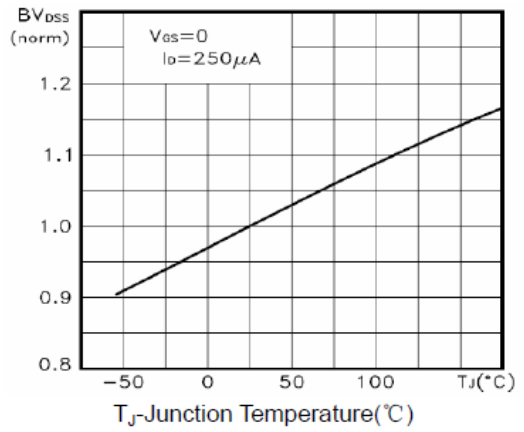

Figure 9 BV_{DSS} vs Junction Temperature

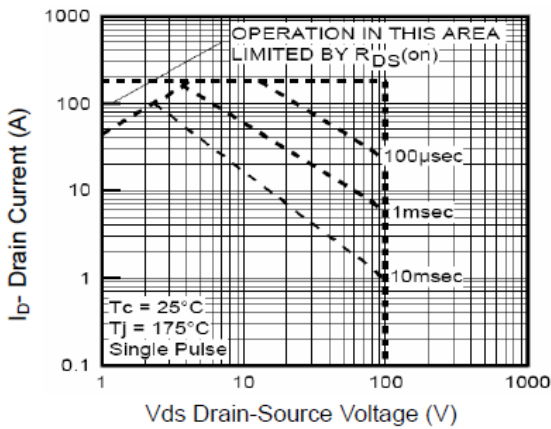

Figure 8 Safe Operation Area

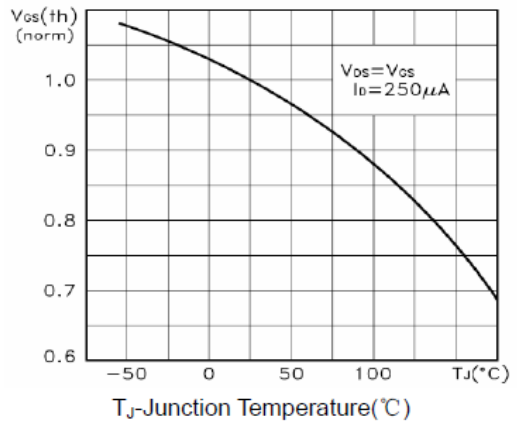

Figure 10 $V_{GS(th)}$ vs Junction Temperature

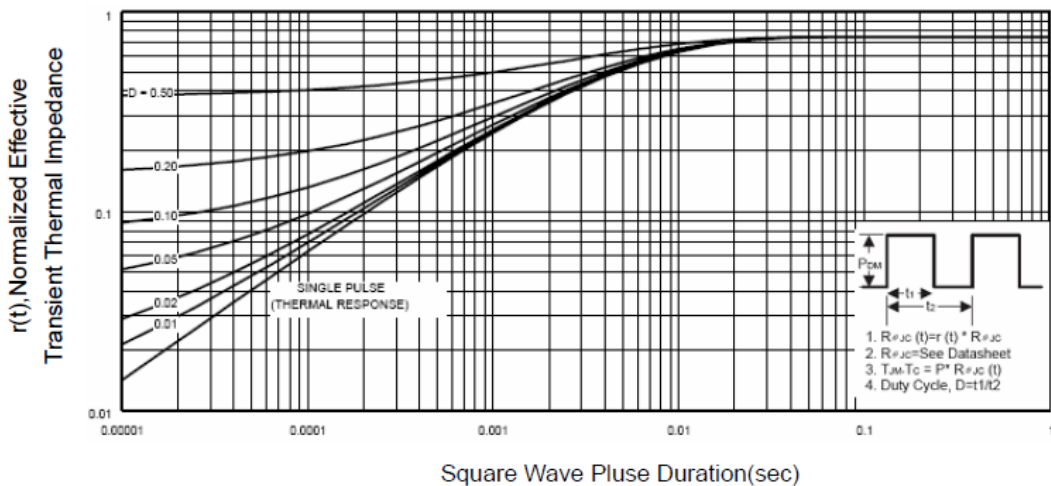
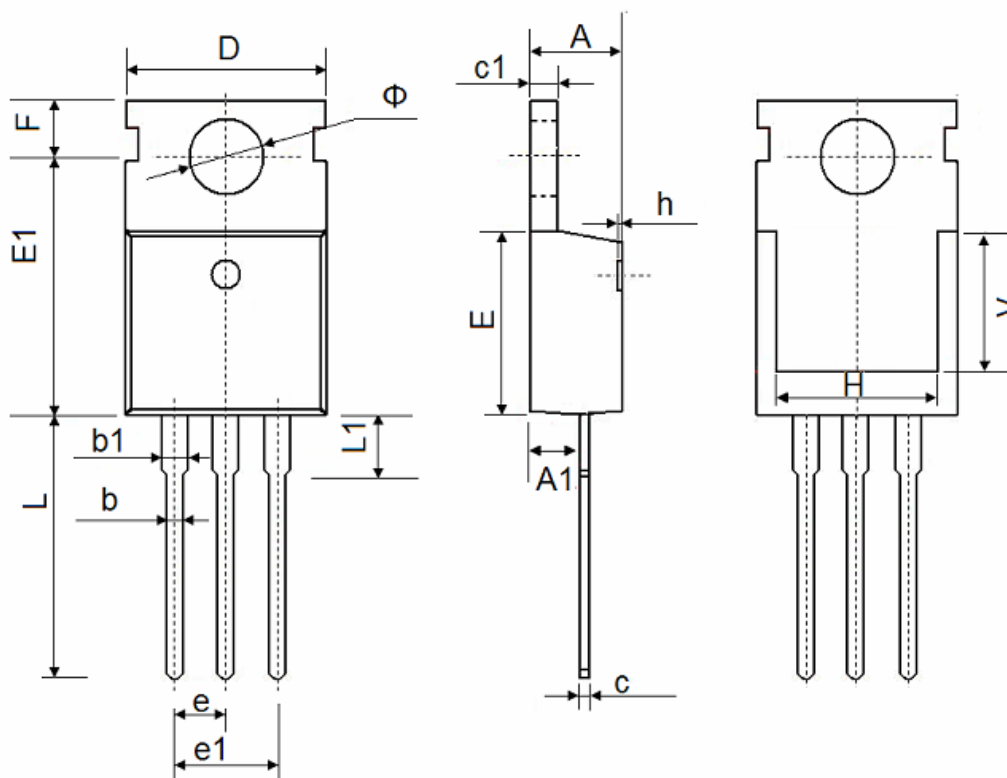

Figure 11 Normalized Maximum Transient Thermal Impedance

SE10060A

Package Outline Dimension

TO-220



Symbol	Dimensions In Millimeters		Dimensions In Inches	
	Min.	Max.	Min.	Max.
A	4.400	4.600	0.173	0.181
A1	2.250	2.550	0.089	0.100
b	0.710	0.910	0.028	0.036
b1	1.170	1.370	0.046	0.054
c	0.330	0.650	0.013	0.026
c1	1.200	1.400	0.047	0.055
D	9.910	10.250	0.390	0.404
E	8.9500	9.750	0.352	0.384
E1	12.650	12.950	0.498	0.510
e	2.540 TYP.		0.100 TYP.	
e1	4.980	5.180	0.196	0.204
F	2.650	2.950	0.104	0.116
H	7.900	8.100	0.311	0.319
h	0.000	0.300	0.000	0.012
L	12.900	13.400	0.508	0.528
L1	2.850	3.250	0.112	0.128
V	7.500 REF.		0.295 REF.	
φ	3.400	3.800	0.134	0.150

The SINO-IC logo is a registered trademark of ShangHai Sino-IC Microelectronics Co., Ltd.

© 2005 SINO-IC - Printed in China - All rights reserved.

SHANGHAI SINO-IC MICROELECTRONICS CO., LTD

Add: Building 3, Room 3401-03, No.200 Zhangheng Road,
ZhangJiang Hi-Tech Park, Pudong, Shanghai 201203, China

Phone: +86-21-33932402 33932403

33932405 33933508 33933608

Fax: +86-21-33932401

Email: szrxw002@126.com

Website: <http://www.sino-ic.net>