

Surface Mount Transient Voltage Suppressors

High temperature stability and high reliability conditions

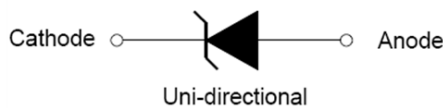

DO-218AB



FEATURES

- Junction passivation optimized design passivated anisotropic rectifier technology.
- $T_J=175^{\circ}\text{C}$ capability suitable for high reliability and automotive requirement.
- Available in uni-directional polarity only.
- Low leakage current.
- Low forward voltage drop.
- High surge capability.
- Meets ISO16750-2 surge specification(varied by test condition).
- Meets MSL-1, per J-STD-020, LF maximum peak of 260°C .
- AEC-Q101 qualified.
- Compliant to RoHS directive 2011/65/EU and in accordance to WEEE 2002/96/EC.

PRIMARY CHARACTERISTICS	
V_R	10V to 43V
P_{PP} (10/1000 μs)	6600W
P_{PP} (10/10000 μs)	5200W
P_D	8W
I_{FSM}	700A
T_{Jmax}	175°C
Polarity	Uni-directional
Package	DO-218AB

TYPICAL APPLICATIONS

Use in sensitive electronics protection against voltage transients induced by inductive load switching and lighting, especially for automotive load dump protection application.

MECHANICAL DATA

Case: DO-218AB

Molding compound meets UL 94V-0 flammability rating
Base P/NHE3-RoHS-compliant, AEC-Q101 qualified

Terminals: Matte tin plated leads, solderable per J-STD-002

MAXIMUM RATINGS($T_C=25^{\circ}\text{C}$, RH=45%-75%, unless otherwise noted)			
Parameter	Symbol	Value	Unit
Peak pulse power dissipation at 10/1000 μs waveform	P_{PP}	6600	Watts
Peak pulse power dissipation at 10/10000 μs waveform		5200	Watts
Power dissipation on infinite heat sink at $T_C=25^{\circ}\text{C}$	P_D	8.0	Watts
Peak pulse current with 10/1000 μs waveform	$I_{PPM}^{(1)}$	See next table	Amps
Peak forward surge current, 8.3ms single half sine-wave	I_{FSM}	700	Amps
Operating junction and storage temperature range	T_J, T_{STG}	-55 to +175	$^{\circ}\text{C}$
Typical thermal resistance, junction to case	$R_{\theta JC}$	0.9	$^{\circ}\text{C}/\text{W}$
Typical thermal resistance, junction to ambient	$R_{\theta JA}$	12	$^{\circ}\text{C}/\text{W}$

Note(1) Non-repetitive current pulse derated above $T_A=25^{\circ}\text{C}$

ELECTRICAL CHARACTERISTICS								
Part Number	V_R	I_T	$I_R@V_R$		$V_{BR}@I_T$		$V_C@I_{PP}$	I_{PP}
Uni-polar	V	mA	$\mu A@25^\circ C$	$\mu A@175^\circ C$	min(V)	max (V)	V	A
SM8S10A-AL	10.0	5	5	250	11.1	12.3	17.0	388
SM8S11A-AL	11.0	5	5	150	12.2	13.5	18.2	363
SM8S12A-AL	12.0	5	5	150	13.3	14.7	19.9	332
SM8S13A-AL	13.0	5	5	150	14.4	15.9	21.5	307
SM8S14A-AL	14.0	5	5	150	15.6	17.2	23.2	284
SM8S15A-AL	15.0	5	5	150	16.7	18.5	24.4	270
SM8S16A-AL	16.0	5	5	150	17.8	19.7	26.0	253
SM8S17A-AL	17.0	5	5	150	18.9	20.9	27.6	239
SM8S18A-AL	18.0	5	5	150	20.0	22.1	29.2	226
SM8S20A-AL	20.0	5	5	150	22.2	24.5	32.4	204
SM8S22A-AL	22.0	5	5	150	24.4	26.9	35.5	186
SM8S24A-AL	24.0	5	5	150	26.7	29.5	38.9	170
SM8S26A-AL	26.0	5	5	150	28.9	31.9	42.1	157
SM8S28A-AL	28.0	5	5	150	31.1	34.4	45.4	145
SM8S30A-AL	30.0	5	5	150	33.3	36.8	48.4	136
SM8S32A-AL	32.0	5	5	150	35.5	39.4	51.4	128.5
SM8S33A-AL	33.0	5	5	150	36.7	40.6	53.3	124
SM8S36A-AL	36.0	5	5	150	40.0	44.2	58.1	114
SM8S40A-AL	40.0	5	5	150	44.4	49.1	64.5	102
SM8S43A-AL	43.0	5	5	150	47.8	52.8	69.4	95.1

Note:

①. For all types maximum $V_F=1.8V$ at $I_F=100A$ measured on 8.3ms single half sine-wave or equivalent square wave, duty cycle=4 pulses per minute maximum.

②. Surge waveform: 10/1000 μs

V_R : Stand-off voltage -- Maximum voltage that can be applied

V_{BR} : Breakdown voltage

V_C : Clamping voltage -- Peak voltage measured across the suppressor at a specified I_{PP}

I_R : Reverse leakage current

I_T : Test current

ORDERING INFORMATION

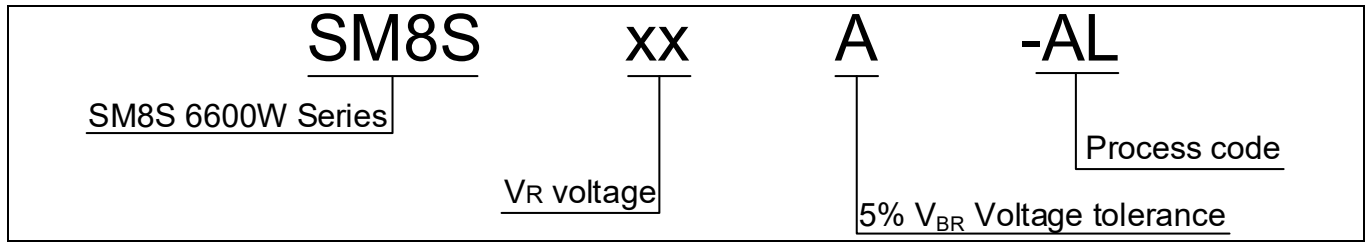

RATINGS AND CHARACTERISTICS CURVES ($T_A=25^\circ C$, unless otherwise noted)

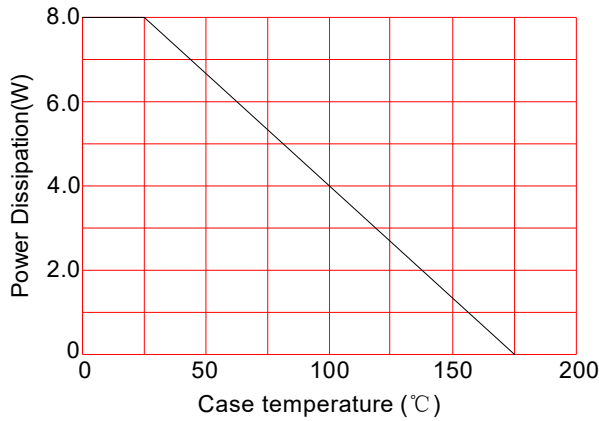

FIG.1: Power derating curve

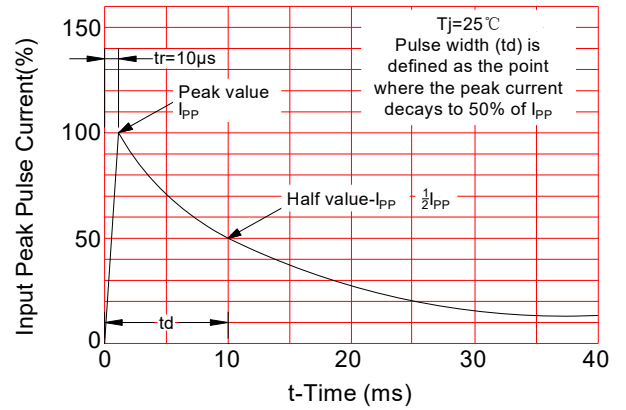

FIG.2: Pulse waveform

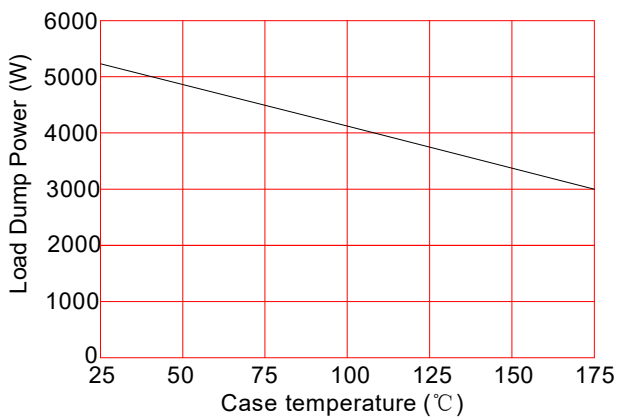

FIG.3: Load dump power characteristics (10ms exponential waveform)

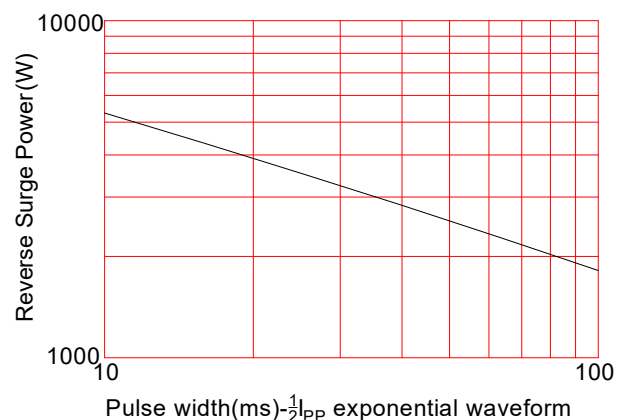

FIG.4: Reverse power capability

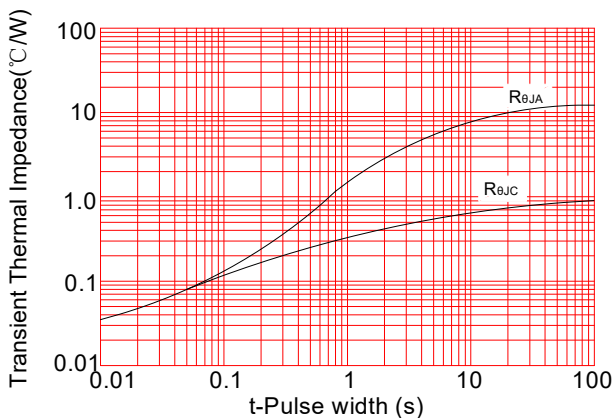

FIG.5: Typical transient thermal impedance

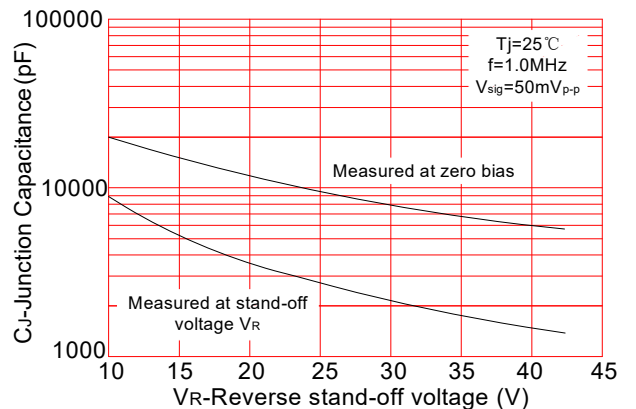

FIG.6: Typical junction capacitance

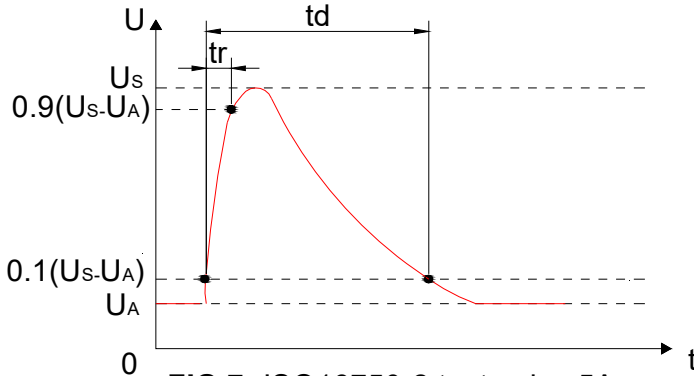

FIG.7: ISO16750-2 test pulse 5A

Parameter	12V system	24V system
U _s	79~101V	151~202V
R _i	0.5~4Ω	1~8Ω
t _d	40~400ms	100~350ms
t _r	5~10ms	5~10ms

FIG.8: Parameters for test pulse 5A

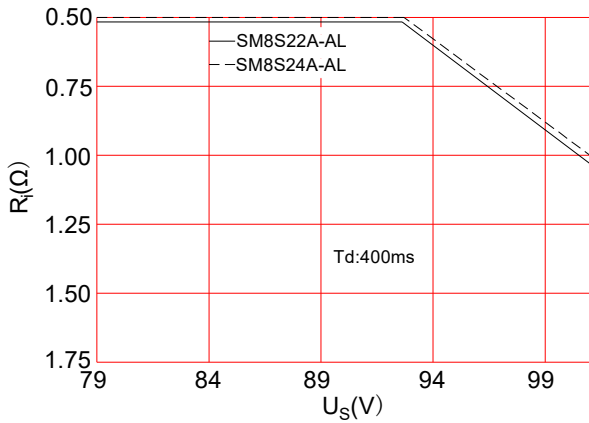

FIG.9: Typical SOA chart
ISO16750-2 5A 12V test system

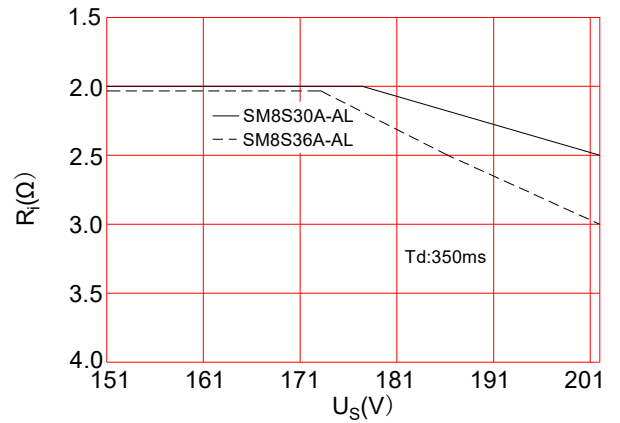
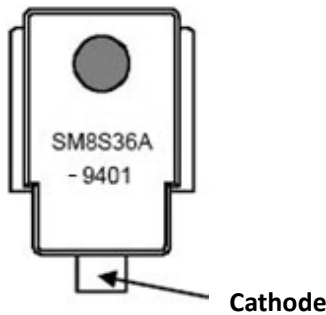

FIG.10: Typical SOA chart
ISO16750-2 5A 24V test system

MARKING



SM	Surface Mount
8S	P _D =8W
36	V _R :36V
A	Uni-directional

x401:

2019	2020	2021	2022	2023	2024
9	0	1	2	3	4
2025	2026	2027	2028	...	
5	6	7	8	...	

9x01: Month, 1、2、3 ~ 9、O、N、D

94xx: Lot number

SOLDERING PARAMETERS

Reflow Condition		Pb-Free assembly (see figure at right)
Pre Heat	-Temperature Min ($T_{s(min)}$)	+150°C
	-Temperature Max($T_{s(max)}$)	+200°C
	-Time (Min to Max) (t_s)	60-180 secs.
Average ramp up rate (Liquidus Temp (T_L) to peak)		3°C/sec. Max
$T_{s(max)}$ to T_L - Ramp-up Rate		3°C/sec. Max
Reflow	-Temperature(T_L)(Liquidus)	+217°C
	-Temperature(t_L)	60-150 secs.
Peak Temp (T_p)		+260(+0/-5)°C
Time within 5°C of actual Peak Temp (t_p)		20-40secs.
Ramp-down Rate		6°C/sec. Max
Time 25°C to Peak Temp (T_p)		8 min. Max
Do not exceed		+260°C

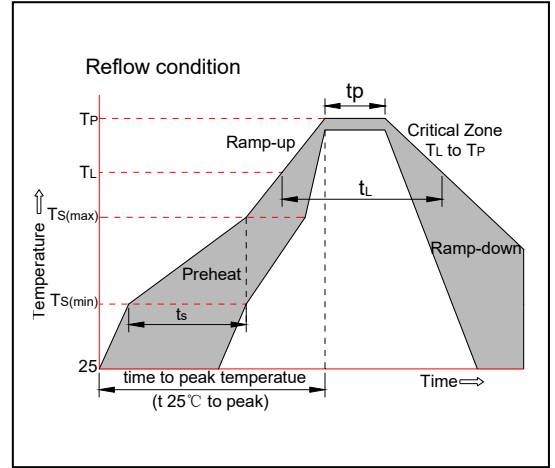

PACKAGE MECHANICAL DATA

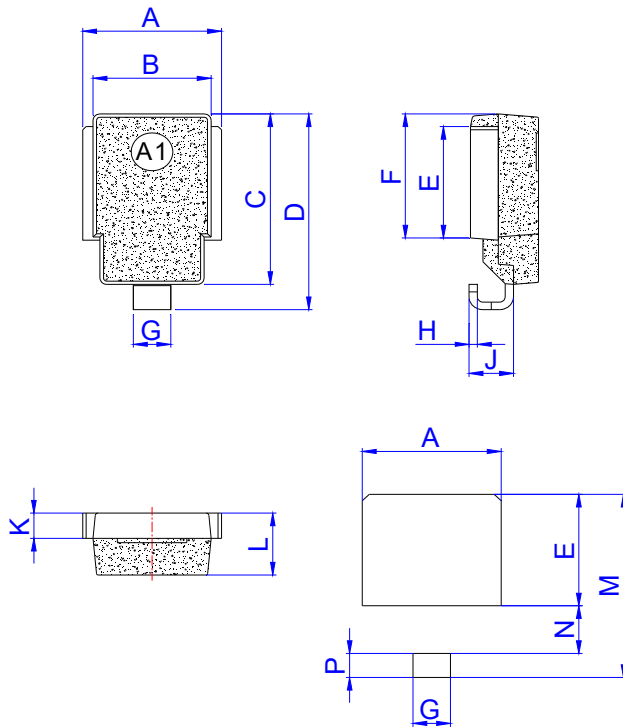

DO-218AB

Ref.	Dimensions			
	Millimeters		Inches	
	Min.	Max.	Min.	Max.
A	9.5	10.5	0.374	0.413
B	8.3	8.7	0.327	0.342
C	13.3	13.7	0.524	0.539
D	15.0	16.0	0.592	0.628
E	8.5	9.1	0.335	0.358
F	9.5	10.1	0.374	0.398
G	2.4	3.0	0.094	0.118
H	0.5	0.7	0.020	0.028
J	2.7	3.7	0.106	0.146
K	1.9	2.1	0.075	0.083
L	4.7	5.1	0.185	0.201
M	14.2	14.8	0.559	0.583
N	3.5	4.1	0.138	0.161
P	1.6	2.2	0.063	0.087

TAPE AND REEL SPECIFICATION-DO-218AB

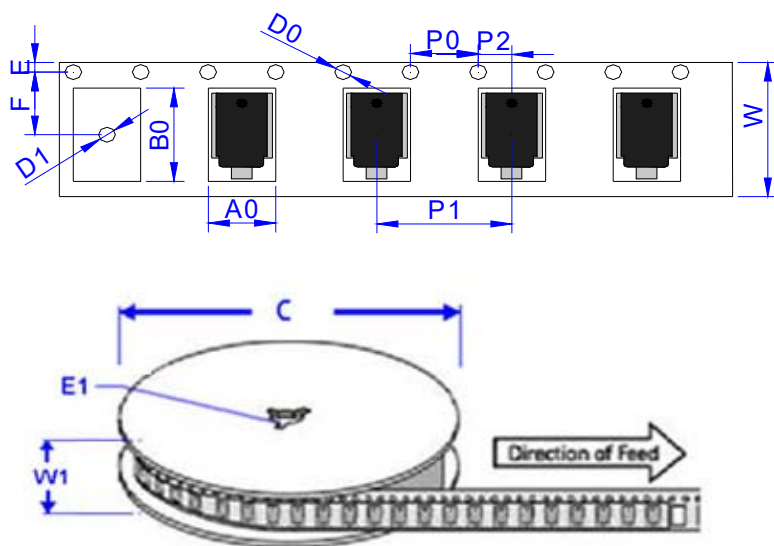

Ref.	Dimensions	
	Millimeters	Inches
A0	10.80 ± 0.3	0.425± 0.012
B0	16.13 ± 0.3	0.635 ± 0.012
C	330.0 ± 0.3	13.0 ± 0.012
D0	1.55 ± 0.2	0.061 ± 0.008
D1	1.55 ± 0.2	0.061± 0.008
E	1.75 ± 0.2	0.069 ± 0.008
E1	13.30 ± 0.2	0.524 ± 0.008
F	11.50 ± 0.2	0.453 ± 0.008
P0	4.00 ± 0.2	0.157 ± 0.008
P1	16.00 ± 0.2	0.630 ± 0.008
P2	2.00 ± 0.2	0.079 ± 0.008
W	24.00 ± 0.2	0.945 ± 0.008
W1	25.85 ± 0.2	1.018 ± 0.008

ORDERING INFORMATION				
PART No.	UNIT WEIGHT (g) typ	REEL (PCS)	PER CARTON (PCS)	DESCRIPTION
SM8SxxA-AL	2.985	750	3000	13 inch reel pack

JieJie products are not designed for, and shall not be used for, any purpose (including, without limitation, automotive, military, aerospace, medical, life-saving, life-sustaining or nuclear facility applications, devices intended for surgical implant into the body, or any other application in which the failure or lack of desired operation of the product may result in personal injury, death, or property damage) other than those expressly set forth in applicable JieJie product documentation. Warranties granted by JieJie shall be deemed void for products used for any purpose not expressly set forth in applicable JieJie documentation. JieJie shall not be liable for any claims or damages arising out of products used in applications not expressly intended by JieJie as set forth in applicable JieJie documentation. The sale and use of JieJie products is subject to JieJie terms and conditions of sale, unless otherwise agreed by JieJie.

Information furnished in this document is believed to be accurate and reliable. However, Jiangsu JieJie Microelectronics Co.,Ltd assumes no responsibility for the consequences of use without consideration for such information nor use beyond it.

Information mentioned in this document is subject to change without notice, apart from that when an agreement is signed, Jiangsu JieJie complies with the agreement.

Products and information provided in this document have no infringement of patents. Jiangsu JieJie assumes no responsibility for any infringement of other rights of third parties which may result from the use of such products and information.

This document is the 3.2nd version which is made in 7-Apr.-2022. This document supersedes and replaces all information previously supplied.

 is a registered trademark of Jiangsu JieJie Microelectronics Co.,Ltd.

Copyright©2022 Jiangsu JieJie Microelectronics Co.,Ltd. Printed All rights reserved.