

# Engineer Drawing

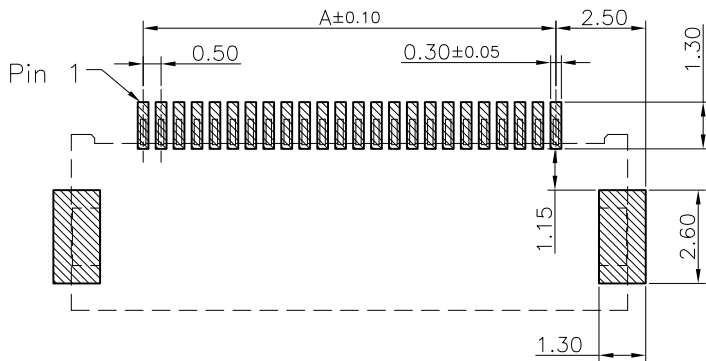
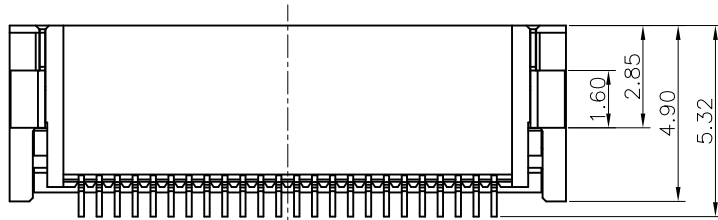
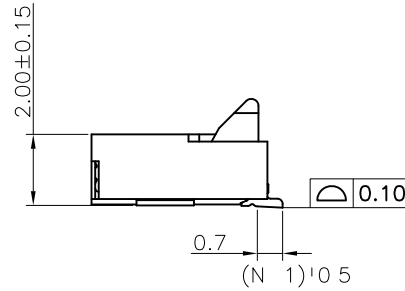
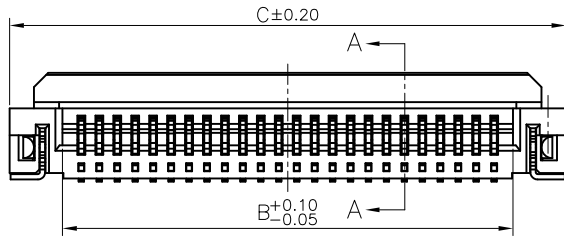
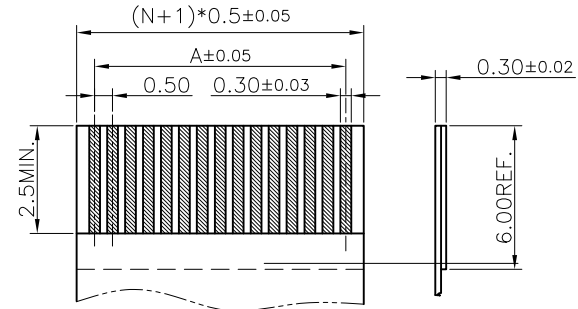
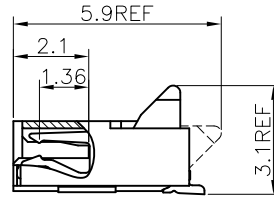
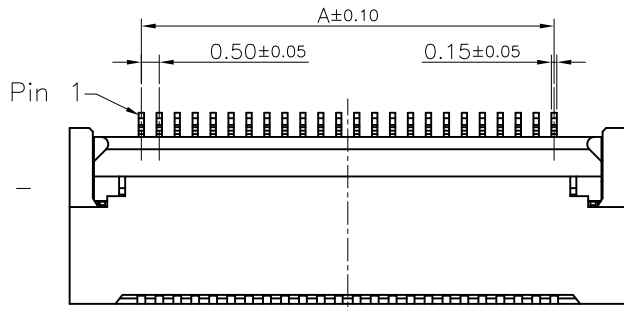

## NOTES:

- MATERIAL:**  
HOUSING: HIGHT-TEMP PLASTIC,UL 94-V0,COLOR:NATURE;  
COVER: HIGHT-TEMP PLASTIC,UL 94-V0,COLOR:BLACK;  
CONTACT: COPPER ALLOY;  
LEG: COPPER ALLOY;
- PLATING:**  
CONTACT AND SOLDER AREA GOLD FLASH PLATED ON  
NICKEL OVER ALL.  
LEG: TIN PLATED ON NICKEL OVER ALL.
- RATING:**  
CURRENT RATING: 0.5A AC/DC  
VOLTAGE RATING: 50V AC/DC  
TEMPERATURE RANGE: -40°C~+85°C;
- PART NO:**

IPFP05202 \*\* \* \* \* \*

- ① Series Type      ④ Company code.  
② Pin code.        ⑤ Packing  
③ Plating            ⑥ Lead Free HF

| CKTS | DIM A | DIM B | DIM C | CKTS | DIM A | DIM B | DIM C |
|------|-------|-------|-------|------|-------|-------|-------|
| 4    | 1.50  | 2.55  | 5.50  | 33   | 16.00 | 17.05 | 20.00 |
| 5    | 2.00  | 3.05  | 6.00  | 34   | 16.50 | 17.55 | 20.50 |
| 6    | 2.50  | 3.55  | 6.50  | 35   | 17.00 | 18.05 | 21.00 |
| 7    | 3.00  | 4.05  | 7.00  | 36   | 17.50 | 18.55 | 21.50 |
| 8    | 3.50  | 4.55  | 7.50  | 37   | 18.00 | 19.05 | 22.00 |
| 9    | 4.00  | 5.05  | 8.00  | 38   | 18.50 | 19.55 | 22.50 |
| 10   | 4.50  | 5.55  | 8.50  | 39   | 19.00 | 20.05 | 23.00 |
| 11   | 5.00  | 6.05  | 9.00  | 40   | 19.50 | 20.55 | 23.50 |
| 12   | 5.50  | 6.55  | 9.50  | 41   | 20.00 | 21.05 | 24.00 |
| 13   | 6.00  | 7.05  | 10.00 | 42   | 20.50 | 21.55 | 24.50 |
| 14   | 6.50  | 7.55  | 10.50 | 43   | 21.00 | 22.05 | 25.00 |
| 15   | 7.00  | 8.05  | 11.00 | 44   | 21.50 | 22.55 | 25.50 |
| 16   | 7.50  | 8.55  | 11.50 | 45   | 22.00 | 23.05 | 25.00 |
| 17   | 8.00  | 9.05  | 12.00 | 46   | 22.50 | 23.55 | 25.50 |
| 18   | 8.50  | 9.55  | 12.50 | 47   | 23.00 | 24.05 | 27.00 |
| 19   | 9.00  | 10.05 | 13.00 | 48   | 23.50 | 24.55 | 27.50 |
| 20   | 9.50  | 10.55 | 13.50 | 49   | 24.00 | 25.05 | 28.00 |
| 21   | 10.00 | 11.05 | 14.00 | 50   | 24.50 | 25.55 | 28.50 |
| 22   | 10.50 | 11.55 | 14.50 | 51   | 25.00 | 26.05 | 29.00 |
| 23   | 11.00 | 12.05 | 15.00 | 52   | 25.50 | 26.55 | 29.50 |
| 24   | 11.50 | 12.55 | 15.50 | 53   | 26.00 | 27.05 | 30.00 |
| 25   | 12.00 | 13.05 | 16.00 | 54   | 26.50 | 27.55 | 30.50 |
| 26   | 12.50 | 13.55 | 16.50 | 55   | 27.00 | 28.05 | 31.00 |
| 27   | 13.00 | 14.05 | 17.00 | 56   | 27.50 | 28.55 | 31.50 |
| 28   | 13.50 | 14.55 | 17.50 | 57   | 28.00 | 29.05 | 32.00 |
| 29   | 14.00 | 15.05 | 18.00 | 58   | 28.50 | 29.55 | 32.50 |
| 30   | 14.50 | 15.55 | 18.50 | 59   | 29.00 | 30.05 | 33.00 |
| 31   | 15.00 | 16.05 | 19.00 | 60   | 29.50 | 30.55 | 33.50 |
| 32   | 15.50 | 16.55 | 19.50 |      |       |       |       |

## TOLERANCE

X ±0.5    XX ±0.15  
X ±0.25    XXX ±0.1  
ANGLES ±2°

[www.i-ncp.com](http://www.i-ncp.com)

PART NO.  
IPFP05202 xx

TITLE:  
0.5 FPC CONN ZIF SMT Easy-on  
H=2.0

DRAWING NO.  
IPFP05202

UNLESS OTHERWISE SPECIFIED

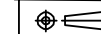

SHEET 1 OF 1

UNITS mm

SCALE 1:1

REV. 01