

Features

- ◆ Wide voltage Operation
- ◆ VCC = 1.8V to 5.5V
- ◆ Low-Power Devices (ISB = 3 μ A @ 5.5V)
Available Operating Ambient Temperature:
-40°C to +85°C Internally Organized 16,384 X 8
(128K), 32,768 X 8 (256K) Two-wire Serial
Interface
- ◆ Schmitt Trigger, Filtered Inputs for Noise
Suppression Bidirectional Data Transfer
Protocol
- ◆ 1MHZ(5V),400kHz(1.8V,2.7V,3.3V)
Compatibility
- ◆ Write Protect Pin for Hardware Data Protection
64-byte Page (128K/256K) Write Modes Partial
Page Writes Allowed
- ◆ Self-timed Write Cycle(5ms max) High-reliability
- ◆ Endurance: 1 Million Write Cycles
- ◆ Data Retention: 100 Years
- ◆ 8-lead PDIP, 8-lead JEDEC SOIC and 8-lead
MSOP Packages

ORDERING INFORMATION

DEVICE	Package Type	MARKING	Packing	Packing Qty
HG24LC128N	DIP8	24LC128	TUBE	2000/box
HG24LC256N	DIP8	24LC256	TUBE	2000/box
HG24LC128M/TR	SOP8	24LC128	REEL	2500/reel
HG24LC256M/TR	SOP8	24LC256	REEL	2500/reel
HG24LC128MM/TR	MSOP8	24LC128	REEL	3000/reel
HG24LC256MM/TR	MSOP8	24LC256	REEL	3000/reel

General Description

The HG24LC128 / 256 provides 131,072/262,144 bits of serial electrically erasable and programmable read-only memory (EEPROM) organized as 4096 words of 8 bits each. The device is optimized for use in many industrial and commercial applications where low-power and low-voltage operation are essential. The HG24LC128 / 256 is available in space-saving 8-lead DIP, 8-lead SOP8 and 8-lead MSOP packages and is accessed via a Two-wire serial interface.

Pin Configuration

DIP8/SOP8/MSOP8

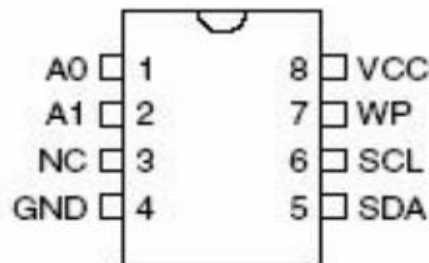

Pin Descriptions

Pin Number	Designation	Type	Name and Functions
1 – 2	A0 – A1	I	Address Inputs DEVICE/PAGE ADDRESSES (A1, A0): The A1 and A0 pins are device address inputs that are hardwired or left not connected for hardware compatibility with other 24LCxx devices. When the pins are hardwired, as many as four 128K/256K devices may be addressed on a single bus system (device addressing is discussed in detail under the Device Addressing section). If the pins are left floating, the A2, A1 and A0 pins will be internally pulled down to GND if the capacitive coupling to the circuit board VCC plane is <3 pF. If coupling is >3 pF, recommends connecting the address pins to GND.
5	SDA	I/O& Open-drain	Serial Data SERIAL DATA (SDA): The SDA pin is bi-directional for serial data transfer. This pin is open-drain driven and may be wire-ORed with any number of other open-drain or open-collector devices.
6	SCL	I	Serial Clock Input SERIAL CLOCK (SCL): The SCL input is used to positive edge clock data into each EEPROM device and negative edge clock data out of each device.
7	WP	I	Write Protect WRITE PROTECT (WP): The write protect input, when connected to GND, allows normal write operations. When WP is connected high to VCC, all write operations to the memory are inhibited. If the pin is left floating, the WP pin will be internally pulled down to GND if the capacitive coupling to the circuit board VCC plane is <3 pF. If coupling is >3 pF, recommends connecting the pin to GND. Switching WP to VCC prior to a write operation creates a software write protect function. The write protection feature is enabled and operates as shown in the following Table 1.
4	GND	P	Ground
8	VCC	P	Power Supply
3	NC	NC	No connect

Table 1: Write Protect

WP Pin Status:	Part of the Array Protected	
	HG24LC128	HG24LC256
At VCC	Full (128K) Array	Full (256K) Array
At GND	Normal Read/Write Operations	

Block Diagram

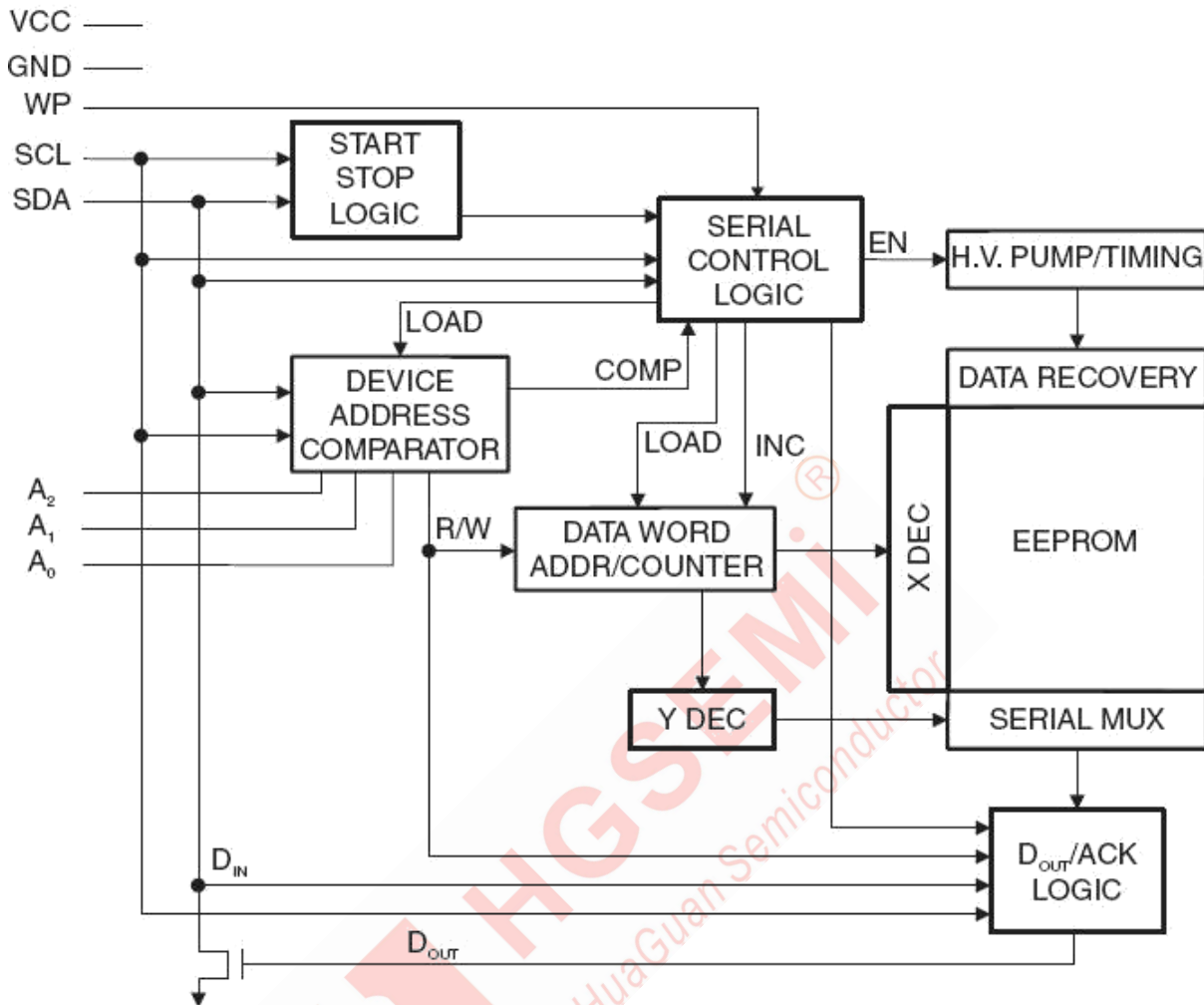

Functional Description

1. Memory Organization

HG24LC128, 128K SERIAL EEPROM: The 128K is internally organized as 256 pages of 64 bytes each. Random word addressing requires a 14 bit data word address.

HG24LC256, 256K SERIAL EEPROM: The 256K is internally organized as 512 pages of 64 bytes each. Random word addressing requires a 15-bit data word address.

2. Device Operation

CLOCK and DATA TRANSITIONS: The SDA pin is normally pulled high with an external device. Data on the SDA pin may change only during SCL low time periods (see to Figure 1 on page 5). Data changes during SCL high periods will indicate a start or stop condition as defined below.

START CONDITION: A high-to-low transition of SDA with SCL high is a start condition which must precede any other command (see to Figure 2 on page 5).

STOP CONDITION: A low-to-high transition of SDA with SCL high is a stop condition. After a read sequence, the stop command will place the EEPROM in a standby power mode (see Figure 2 on page 5).

ACKNOWLEDGE: All addresses and data words are serially transmitted to and from the EEPROM in 8-bit words. The EEPROM sends a “0” to acknowledge that it has received each word. This happens during the ninth clock cycle.

STANDBY MODE: The HG24LC128 / 256 features a low-power standby mode which is enabled: (a) upon power-up and (b) after the receipt of the STOP bit and the completion of any internal operations

MEMORY RESET: After an interruption in protocol, power loss or system reset, any two-wire part can be reset by following these steps:

1. Clock up to 9 cycles.
2. Look for SDA high in each cycle while SCL is high.
3. Create a start condition.

Figure 1. Data Validity

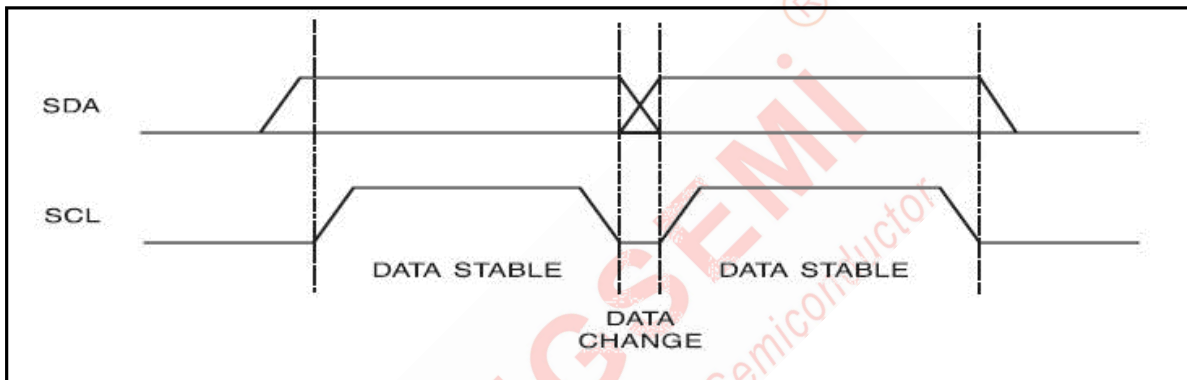

Figure 2. Start and Stop Definition

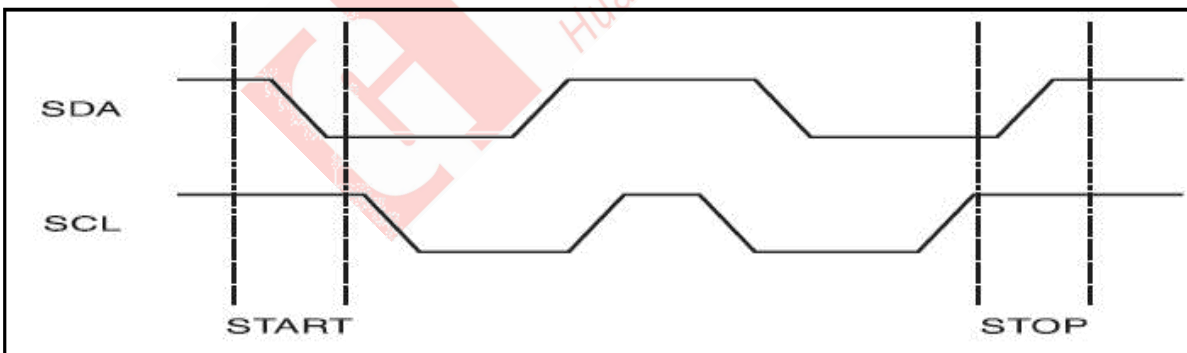
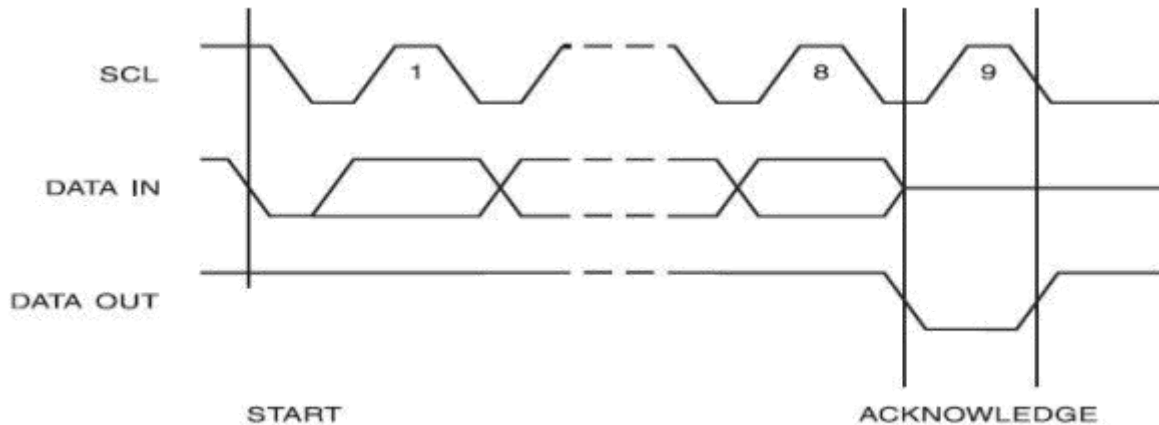

Figure 3. Output Acknowledge

3. Device Addressing

The 128K/256K EEPROM devices all require an 8-bit device address word following a start condition to enable the chip for a read or write operation (see to Figure 4 on page 5).

The device address word consists of a mandatory “1”, “0” sequence for the first four most significant bits as shown. This is common to all the Serial EEPROM devices.

The 128K/256K uses the three device address bits A2, A1, A0 to allow as many as eight devices on the same bus. These bits must compare to their corresponding hardwired input pins. The A2, A1, and A0 pins use an internal proprietary circuit that biases them to a logic low condition if the pins are allowed to float.

The eighth bit of the device address is the read/write operation select bit. A read operation is initiated if this bit is high and a write operation is initiated if this bit is low.

Upon a compare of the device address, the EEPROM will output a “0”. If a compare is not made, the chip will return to a standby state.

NOISE PROTECTION: Special internal circuitry placed on the SDA and SCL pins prevent small noise spikes from activating the device.

DATA SECURITY: The HG24LC128 / 256 has a hardware data protection scheme that allows the user to write protect the entire memory when the WP pin is at VCC.

Write Operations

BYTE WRITE: A write operation requires an 8-bit data word address following the device address word and acknowledgment. Upon receipt of this address, the EEPROM will again respond with a “0” and then clock in the first 8-bit data word. Following receipt of the 8-bit data word, the EEPROM will output a “0” and the addressing device, such as a microcontroller, must terminate the write sequence with a stop condition. At this time the EEPROM enters an internally timed write cycle, t_{WR} , to the nonvolatile memory. All inputs are disabled during this write cycle and the EEPROM will not respond until the write is complete (see Figure 5 on page 8).

PAGE WRITE: The 128K/256K devices are capable of 64-byte page writes.

A page write is initiated the same as a byte write, but the microcontroller does not send a stop condition after the first data word is clocked in. Instead, after the EEPROM acknowledges receipt of the first data word, the microcontroller can transmit up to 63 more data words. The EEPROM will respond with a “0” after each data word received. The microcontroller must terminate the page write sequence with a stop condition (see Figure 6 on page 8).

The data word address lower six (128K/256K) bits are internally incremented following the receipt of each data word. The higher data word address bits are not incremented, retaining the memory page row location. When the word address, internally generated, reaches the page boundary, the following byte is placed at the beginning of the same page. If more than 64 data words are transmitted to the EEPROM, the data word address will “roll over” and previous data will be overwritten.

ACKNOWLEDGE POLLING: Once the internally timed write cycle has started and the EEPROM inputs are disabled, acknowledge polling can be initiated. This involves sending a start condition followed by the device address word. The read/write bit is representative of the operation desired. Only if the internal write cycle has completed will the EEPROM respond with a “0”, allowing the read or write sequence to continue.

Read Operations

Read operations are initiated the same way as write operations with the exception that the read/write select bit in the device address word is set to “1”. There are three read operations: current address read, random address read and sequential read.

CURRENT ADDRESS READ: The internal data word address counter maintains the last address accessed during the last read or write operation, incremented by one. This address stays valid between operations as long as the chip power is maintained. The address “roll over” during read is from the last byte of the last memory page to the first byte of the first page. The address “roll over” during write is from the last byte of the current page to the first byte of the same page.

Once the device address with the read/write select bit set to “1” is clocked in and acknowledged by the EEPROM, the current address data word is serially clocked out. The microcontroller does not respond with an input “0” but does generate a following stop condition (see Figure 7 on page 8).

RANDOM READ: A random read requires a “dummy” byte write sequence to load in the data word address. Once the device address word and data word address are clocked in and acknowledged by the EEPROM, the microcontroller must generate another start condition. The microcontroller now initiates a current address read by sending a device address with the read/write select bit high. The EEPROM acknowledges the device address and serially clocks out the data word. The microcontroller does not respond with a “0” but does generate a following stop condition (see Figure 8 on page 8).

SEQUENTIAL READ: Sequential reads are initiated by either a current address read or a random address read. After the microcontroller receives a data word, it responds with an acknowledge. As long as the EEPROM receives an acknowledge, it will continue to increment the data word address and serially clock out sequential data words. When the memory address limit is reached, the data word address will “roll over” and the sequential read will continue. The sequential read operation is terminated when the microcontroller does not respond with a “0” but does generate a following stop condition (see Figure 9 on page 9)

Figure 4. Device Address

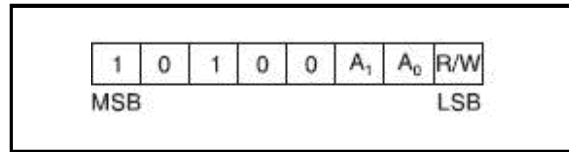

Figure 5. Byte Write

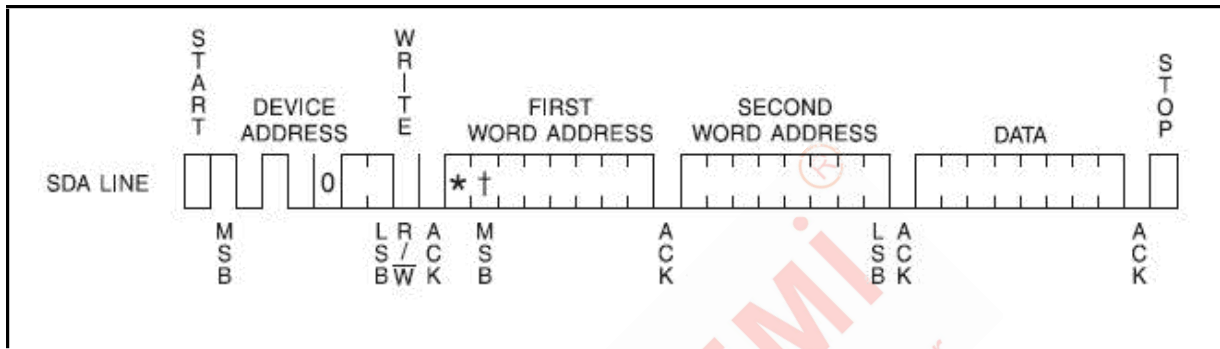

Figure 6. Page Write

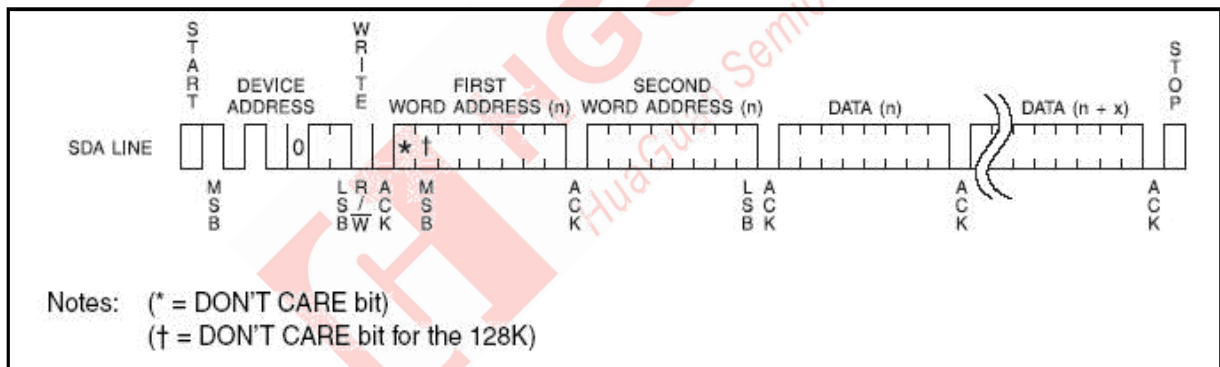

Figure 7. Current Address Read

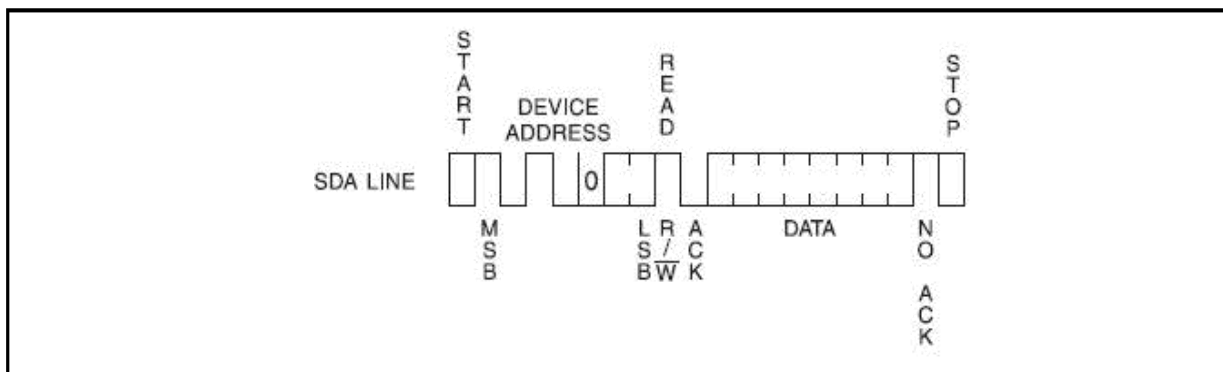

Figure 8. Random Read

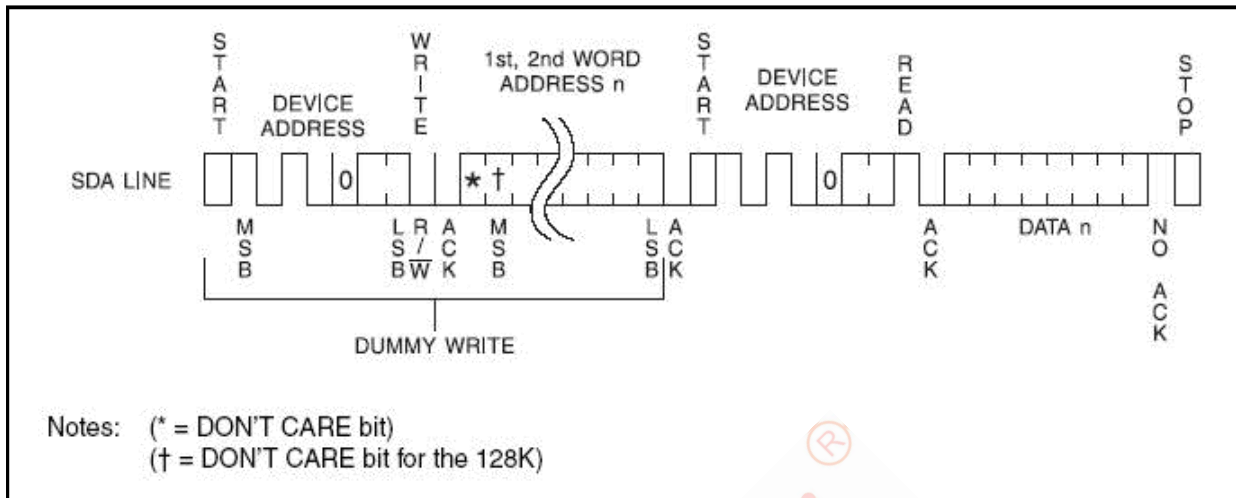
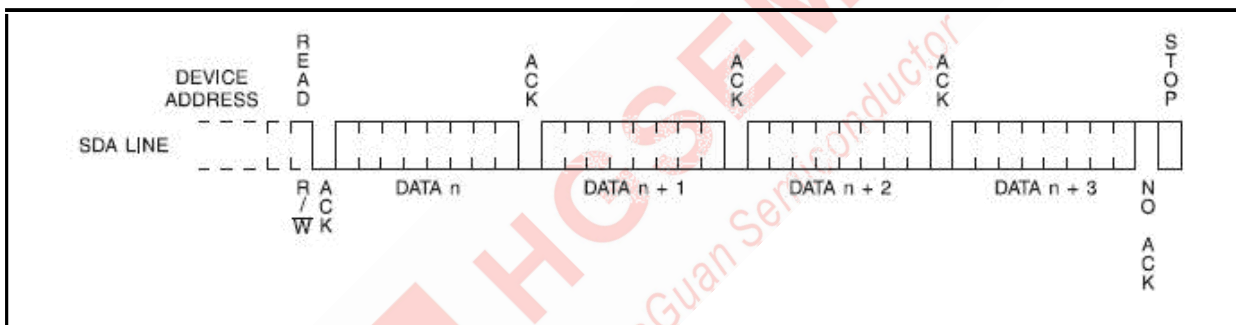

Figure 9. Sequential Read



Electrical Characteristics

Absolute Maximum Stress Ratings

Symbol	Parameter	Value	Unit
VCC	Supply Voltage	+6.5	V
Vo	Input / Output Voltage	GND-0.3 to VCC+0.3	V
Tamb	Operating Ambient Temperature	-40to+85	°C
Tstg	Storage Temperature	-55to125	°C

*Comments

Stresses above those listed under "**Absolute Maximum Ratings**" may cause permanent damage to this device. These are stress ratings only. Functional operation of this device at these or any other conditions above those indicated in the operational sections of this specification is not implied or intended. Exposure to the absolute maximum rating conditions for extended periods may affect device reliability.

DC Electrical Characteristics

Applicable over recommended operating range from: TA = -40°C to +85°C, VCC = +1.8V to +5.5V
 (unless otherwise noted)

Parameter	Symbol	Min.	Typ.	Max.	Unit	Condition
Supply Voltage	V _{CC1}	1.8	-	5.5	V	
Supply Voltage	V _{CC2}	2.5	-	5.5	V	
Supply Voltage	V _{CC3}	2.7	-	5.5	V	
Supply Voltage	V _{CC4}	4.5	-	5.5	V	
Supply Current VCC=5.0V	I _{CC1}	-	0.4	1.0	mA	READ at 400 kHz
Supply Current VCC=5.0V	I _{CC2}	-	2.0	3.0	mA	WRITE at 400 kHz
Supply Current VCC=1.8V	I _{SB1}	-0.6		1.0		V _{IN} =VCC or VSS
Supply Current VCC=2.5V	I _{SB2}	-1.0		2.0		V _{IN} =VCC or VSS
Supply Current VCC=2.7V	I _{SB3}	-1.0		2.0		V _{IN} =VCC or VSS
Supply Current VCC=5.0V	I _{SB4}	-1.0		3.0		V _{IN} =VCC or VSS
Input Leakage Current	I _{LI}	-	0.10	3.0		V _{IN} =VCC or VSS
Output Leakage Current	I _{LO}	-	0.05	3.0		V _{IN} =VCC or VSS
Input Low Level	V _{IL}	-0.6	-	VCC×0.3	V	
Input High Level	V _{IH}	VCC×0.7	-	VCC+0.5	V	
Output Low Level VCC=5.0V	V _{OL3}	-	-	0.4V		
Output Low Level VCC=3.0V	V _{OL2}	-	-	0.4	V	
Output Low Level VCC=1.8V	V _{OL1}	-	-	0.2	V	

Pin Capacitance

Applicable over recommended operating range from TA=25°C, f=1.0MHz, VCC=+1.8V

Parameter	Symbol	Min.	Typ.	Max.	Unit	Condition
Input/Output Capacitance(SDA)	C _{I/O}	-	-	8pF		V _{I/O} =0V
Input Capacitance(A0,A1,A2,SCL)	C _{IN}	-	-	8pF		V _{IN} =0V

AE Electrical Characteristics

Applicable over recommended operating range from: TA = -40°C to +85°C, VCC = +1.8V to +5.5V, CL=1TTL Gate and 100pF(unless otherwise noted)

Parameter Symbol		1.8, 2.7, 5.0-volt			Units
		Min.	Typ.	Max.	
Clock Frequency, SCL	f _{SCL}	-	-	400	kHz
Clock Pulse Width Low	t _{LOW}	1.2	-	-	μs
Clock Pulse Width High	t _{HIGH}	0.6	-	-	μs
Noise Suppression Time	t _I	-	-	50	ns
Clock Low to Data Out Valid	t _{AA}	0.1	-	0.9	μs

Time the bus must be free before a new transmission can start	t_{BUF}	1.2	-	-	μs
Start Hold Time	$t_{HD.STA}$	0.6	-	-	μs
Start Setup Time	$t_{SU.STA}$	0.6	-	-	μs
Data In Hold Time	$t_{HD.DAT}$	0	-	-	μs
Data In Setup Time	$t_{SU.DAT}$	100	-	-	ns
Inputs Rise Time	t_R	-	-	0.3	μs
Inputs Fall Time	t_F	-	-	300	ns
Stop Setup Time	$t_{SU.STO}$	0.6	-	-	μs
Data Out Hold Time	t_{DH}		50 -	-	ns
Write Cycle Time	t_{WR}	-	-	5	ms
5.0V, 25 °C, Byte Mode	Endurance	1M	-	-	Write Cycles

Bus Timing

Figure 10.SCL: Serial Clock, SDA: Serial Data I/O

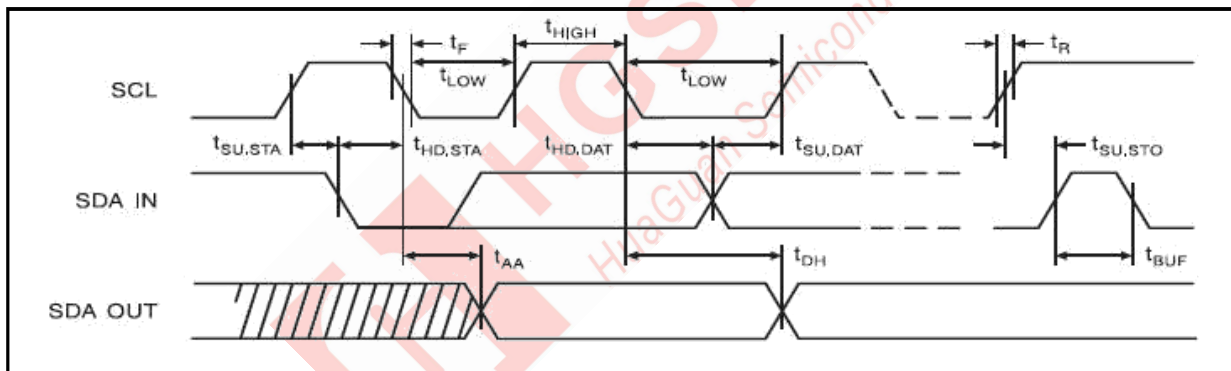

Write Cycle Timing

Figure 11.SCL: Serial Clock, SDA: Serial Data I/O

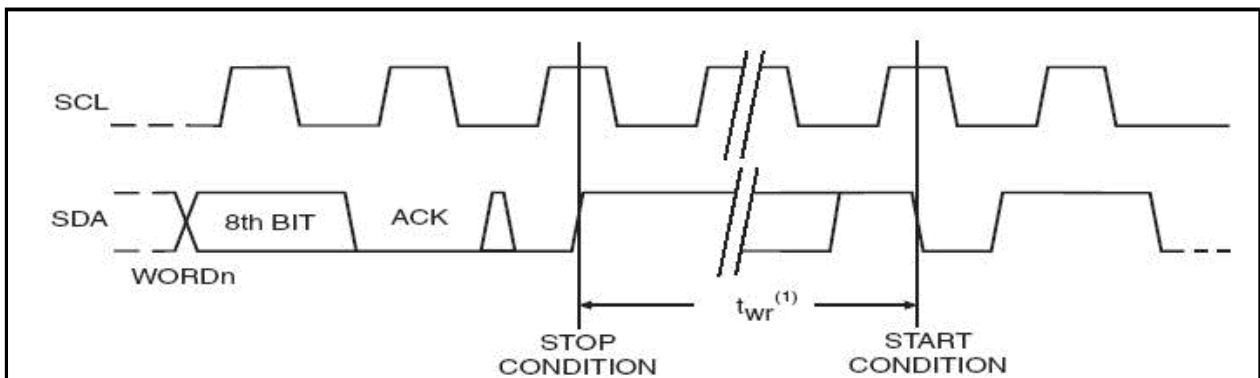

Note: 1. The write cycle time t_{WR} is the time from a valid stop condition of a write sequence to the end of the internal clear/write cycle.

Physical Dimensions

SOP-8L

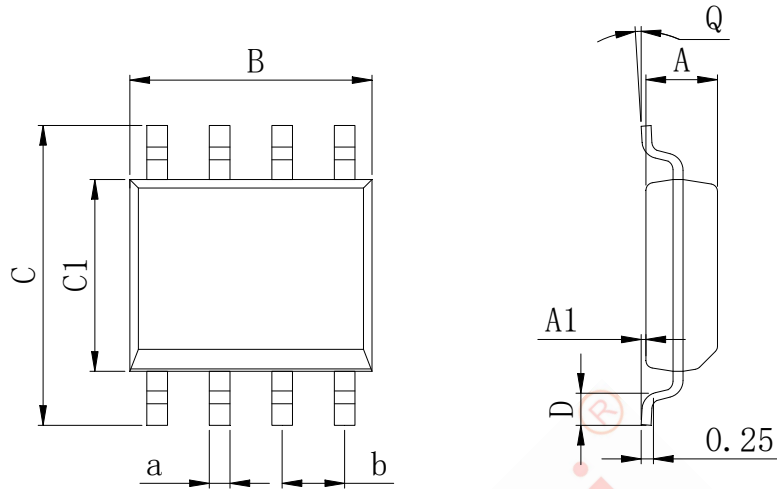

Dimensions In Millimeters(SOP8L)

Symbol:	A	A1	B	C	C1	D	Q	a	b
Min:	1.35	0.05	4.90	5.80	3.80	0.40	0°	0.35	1.27 BSC
Max:	1.55	0.20	5.10	6.20	4.00	0.80	8°	0.45	

DIP-8L

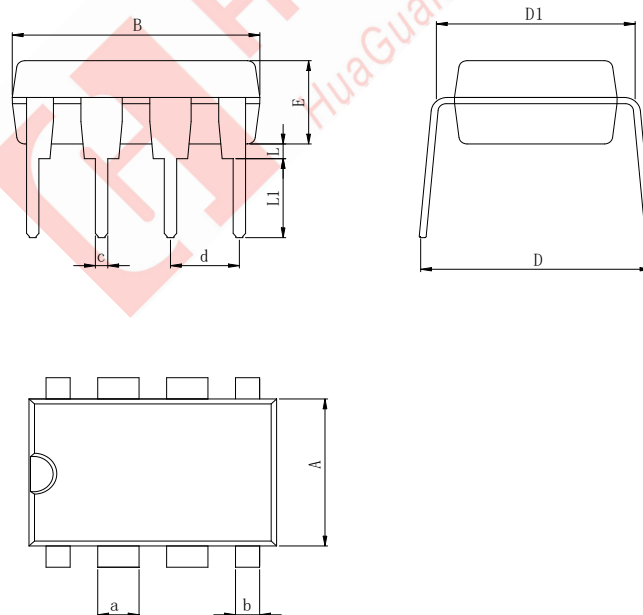

Dimensions In Millimeters(DIP8L)

Symbol:	A	B	D	D1	E	L	L1	a	b	c	d
Min:	6.10	9.00	8.40	7.42	3.10	0.50	3.00	1.50	0.85	0.40	2.54 BSC
Max:	6.68	9.50	9.00	7.82	3.55	0.70	3.60	1.55	0.90	0.50	

Physical Dimensions

MSOP8

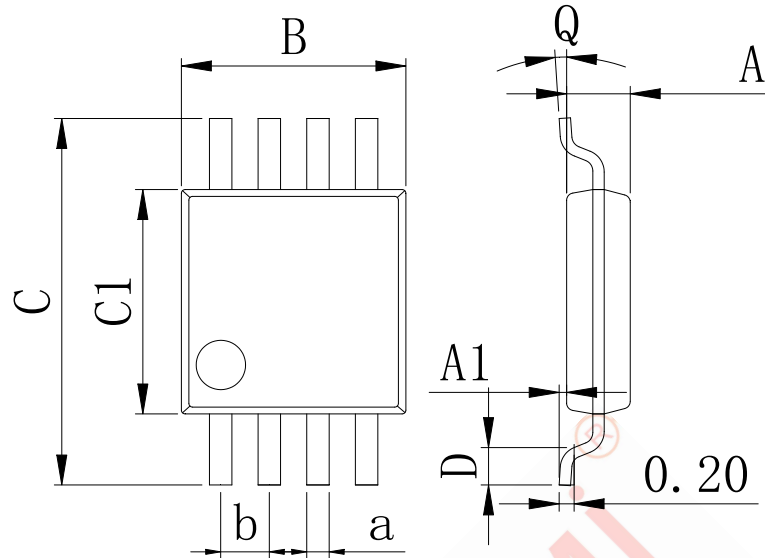

Dimensions In Millimeters(MSOP8L)									
Symbol:	A	A1	B	C	C1	D	Q	a	b
Min:	0.80	0.05	2.90	4.75	2.90	0.35	0°	0.25	0.65 BSC
Max:	0.90	0.20	3.10	5.05	3.10	0.75	8°	0.35	

IMPORTANT STATEMENT:

Huaguan Semiconductor Co,Ltd. reserves the right to change the products and services provided without notice. Customers should obtain the latest relevant information before ordering, and verify the timeliness and accuracy of this information.

Customers are responsible for complying with safety standards and taking safety measures when using our products for system design and machine manufacturing to avoid potential risks that may result in personal injury or property damage.

Our products are not licensed for applications in life support, military, aerospace, etc., so we do not bear the onsequences of the application of these products in these fields.

Huaguan Semiconductor Co,Ltd. the performance of the semiconductor products produced by the company can reach the performance indicators that can be applied at the time of sales. The use of testing and other quality control technologies is limited to the quality assurance scope of Huaguan semiconductor. Not all parameters of each device need to be tested. The above documents are for reference only, and all are subject to the physical parameters.

Our documentation is only permitted to be copied without any tampering with the content, so we do not accept any responsibility or liability for the altered documents.