



ORIENT

Photo coupler

Product Data Sheet

Part Number: OR-314

Customer: _____

Date: _____

SHENZHEN ORIENT COMPONENTS CO., LTD

Block A 3rd Floor No.4 Building, Tian'an Cyber Park, Huangge Rd, LongGang Dist, Shenzhen, GD

TEL: 0755-29681816

FAX: 0755-29681200

www.orient-opto.com

1. Features

- (1) High speed response.
- (2) Ultra high CMR.
- (3) Bootstrappable supply current.
- (4) 0.6-A maximum peak output current
- (5) 0.4-A minimum peak output current
- (6) 0.7- μ s maximum propagation delay over temperature range
- (7) $I_{CC(max)} = 3$ -mA maximum supply current
- (8) 25 kV/ μ s minimum common mode rejection (CMR) at $V_{CM} = 1500$ V
- (9) Wide VCC operating range: 10V to 30V over temperature range
- (10) Available in Stretched SO-6 package
- (11) Industrial temperature range: -40° C to 105° C
- (12) Safety approval
 - UL approved(No.E323844)
 - VDE approved(No.40029733)
 - CQC approved (No.CQC19001231480)
- (13) In compliance with RoHS, REACH standard
- (14) MSL Level 1

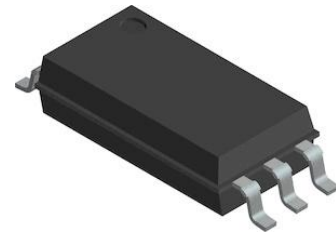

2. Description

The OR-314 consists of a GaAsP LED optically coupled to an integrated circuit with a power output stage. These optocouplers are ideally suited for driving power IGBTs and MOSFETs used in motor control inverter applications. The high operating voltage range of the output stage provides the drive voltages required by gate controlled devices. The voltage and current supplied by this optocoupler makes it ideally suited for directly driving small or medium power IGBTs.

3. Application Range

- (1) Isolated IGBT/Power MOSFET gate drive
- (2) AC and Brushless DC motor drives
- (3) Industrial inverters
- (4) Inverter for home appliances
- (5) Switching power supplies
- (6) Induction cooker

4. Functional Diagram

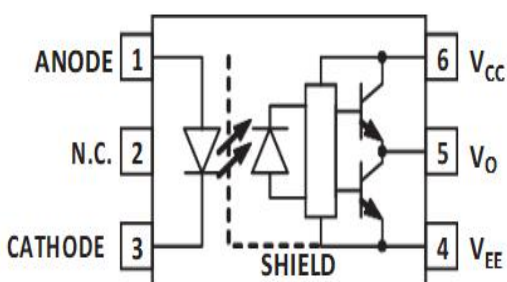

Truth Table	
LED	VO
OFF	LOW
ON	HIGH

Note: A 1 μ F bypass capacitor must be connected between pins VCC and VEE.

5. Absolute Maximum Ratings (Ta=25°C)

Parameter		Symbol	Rated Value	Unit
Input	Average Forward Input Current	I_F	25	mA
	Reverse Input Voltage	V_R	5	V
Output	“High” Peak Output Current	$I_{OH(PEAK)}$	0.6	A
	“Low” Peak Output Current	$I_{OL(PEAK)}$	0.6	A
	Output Collector Power Dissipation	P_O	250	mW
Total Output Supply Voltage		$V_{CC} - V_{EE}$	-0.5~35	V
Output Voltage		$V_{O(PEAK)}$	-0.5~ V_{CC}	V
Input Current (Rise/Fall Time)		$t_{r(IN)} / t_{f(IN)}$	500	ns
Insulation Voltage		V_{iso}	5000	V _{rms}
Working Temperature		T_{opr}	-40 ~ + 105	°C
Storage Temperature		T_{stg}	-55 ~ + 125	
*2 Soldering Temperature		T_{sol}	260	

*1. Room temperature = 25 °C. Exceeding the maximum absolute rating can permanently damage the device. Working long hours at the maximum absolute rating can affect reliability.

*2. soldering time is 10 seconds.

6. Electrical Optical Characteristics at Ta=25°C

Parameter	Symbol	Min.	Typ.	Max.	Units	Test Conditions
High Level Output Current	I_{OH}	0.2	—	—	A	$V_O = (V_{CC} - 4V)$
		0.4	0.5	—		$V_O = (V_{CC} - 10V)$
Low Level Output Current	I_{OL}	0.2	0.4	—	A	$V_O = (V_{EE} + 2.5V)$
		0.4	0.5	—		$V_{CC} - V_O \leq 15V$
High Level Output Voltage	V_{OH}	$(V_{CC} - 4)$	$(V_{CC} - 1.8)$	—	V	$I_O = -100 \text{ mA}$
Low Level Output Voltage	V_{OL}	—	0.4	1	V	$I_O = 100 \text{ mA}$
High Level Supply Current	I_{CCH}	—	0.7	3.0	mA	$I_F = 10 \text{ mA}$
Low Level Supply Current	I_{CCL}	—	1.2	3.0	mA	$I_F = 0 \text{ V}$
Threshold Input Current Low to High	I_{FLH}	—	—	7.0	mA	$C_g = 25 \text{ nF}, V_O > 5 \text{ V}$
Threshold Input Voltage High to Low	V_{FHL}	0.8	—	—	V	
Input Forward Voltage	V_F	1.2	1.55	1.95	V	$I_F = 10 \text{ mA}$
Temperature Coefficient of Forward Voltage	$\Delta V_F / \Delta T_A$	—	-1.7	—	mV/°C	$I_F = 10 \text{ mA}$
Input Reverse Breakdown Voltage	B_{VR}	5	—	—	V	$I_R = 100 \mu\text{A}$
Input Capacitance	C_{IN}	—	70	—	pF	$f = 1 \text{ MHz}, V_F = 0V$

7. Switching Characteristics

Parameter	Symbol	Min.	Typ	Max.	Units	Test Conditions
Propagation Delay Time to High Output Level	t_{PLH}	0.1	0.2	0.7	μs	$R_g = 47 \Omega,$ $C_g = 3 \text{ nF},$ $f = 10 \text{ kHz},$ Duty Cycle = 50% $I_F = 8 \text{ mA},$ $V_{CC} = 30 \text{ V}$
Propagation Delay Time to Low Output Level	t_{PHL}	0.1	0.3	0.7	μs	
Propagation Delay Difference Between Any Two Parts	P_{DD}	-0.5	—	0.5	μs	
Rise Time	t_r	—	50	—	ns	
Fall Time	t_f	—	50	—	ns	
Output High Level Common Mode Transient Immunity	$ CM_H $	25	—	—	kV/ μs	$T_A = 25^\circ \text{ C},$ $V_{CM} = 1500 \text{ V}$
Output Low Level Common Mode Transient Immunity	$ CM_L $	25	—	—		



8. Order Information

Part Number

OR-314U-Y-Z

Note

314= Part Number .

U = Lead form option ,W or W1 .

Y = Tape and reel option (TA,TA1 or none) .

Z = 'V' code for VDE safety (This options is not necessary).

* VDE Code can be selected.

Option	Description	Packing quantity
S(TA)	Surface mount lead form (low profile) + TA tape & reel option	1000 units per reel
S(TA1)	Surface mount lead form (low profile) + TA1 tape & reel option	1000 units per reel

9. Naming Rule

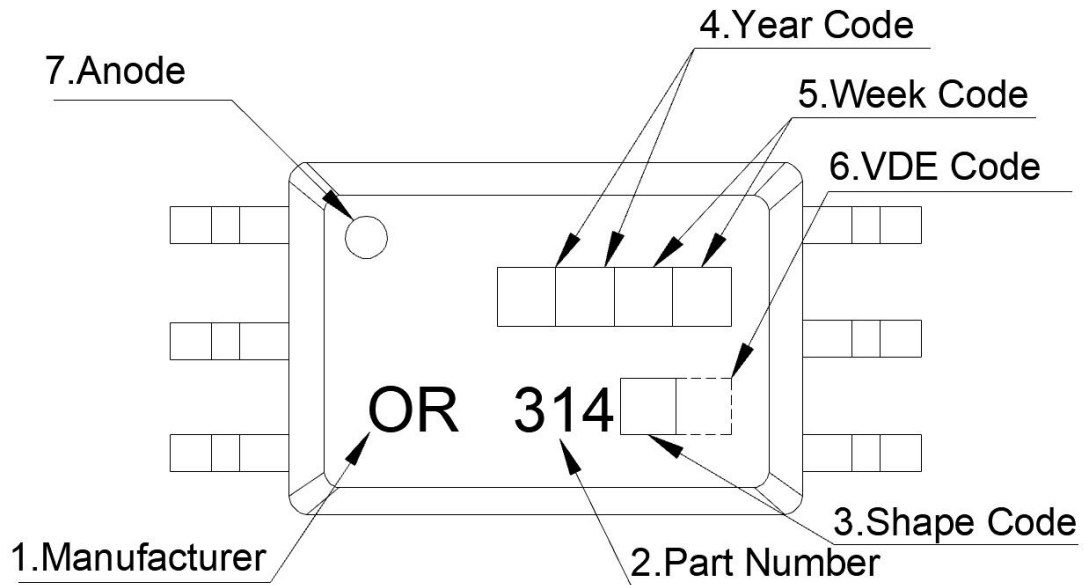

1. Manufacturer : ORIENT.
2. Part Number : 314.
3. Shape Code : Lead form option ,W or W1 .
4. Year Code : '21' means '2021' and so on.
5. Week Code : 01 means the first week, 02 means the second week and so on.
6. VDE Code . (Optional)
7. Anode.

* VDE Mark can be selected.

10. Package Dimension

(1).OR-314W

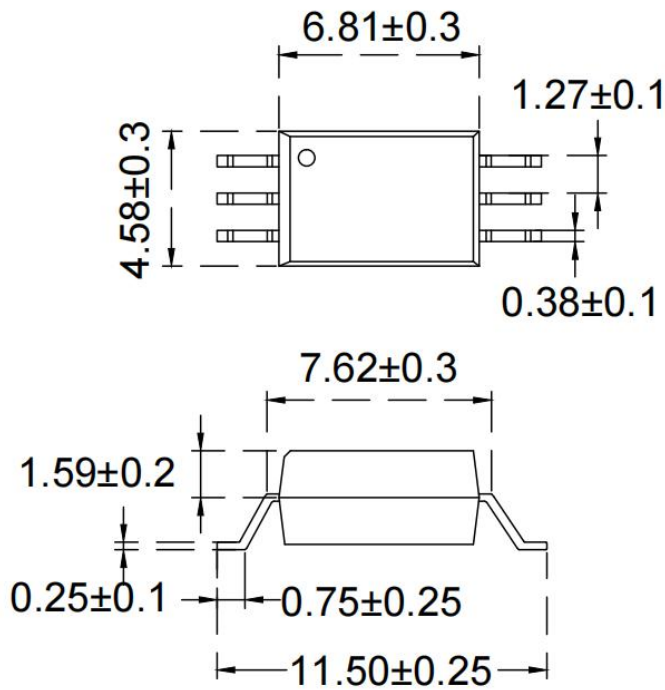

Land Pattern Recommendation

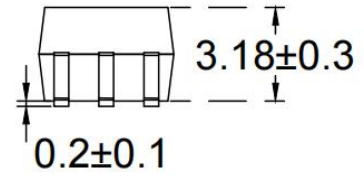
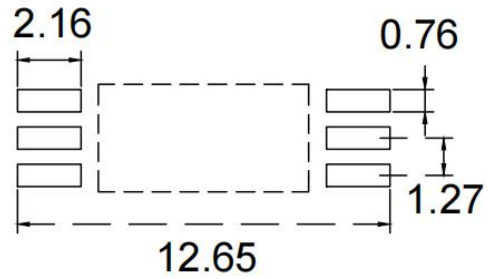

(2).OR-314W1

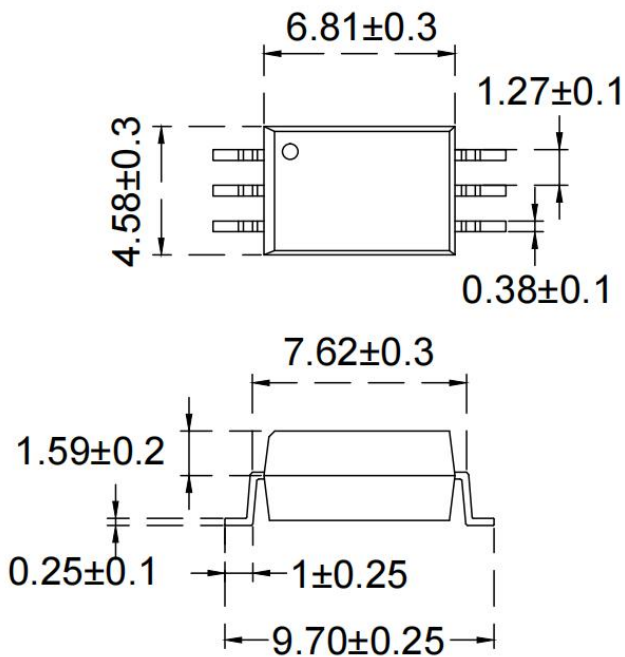

Land Pattern Recommendation

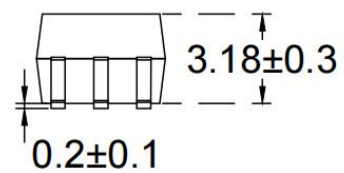
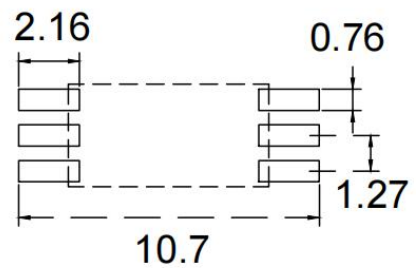

11. Taping Dimensions

(1)OR-314W-TA

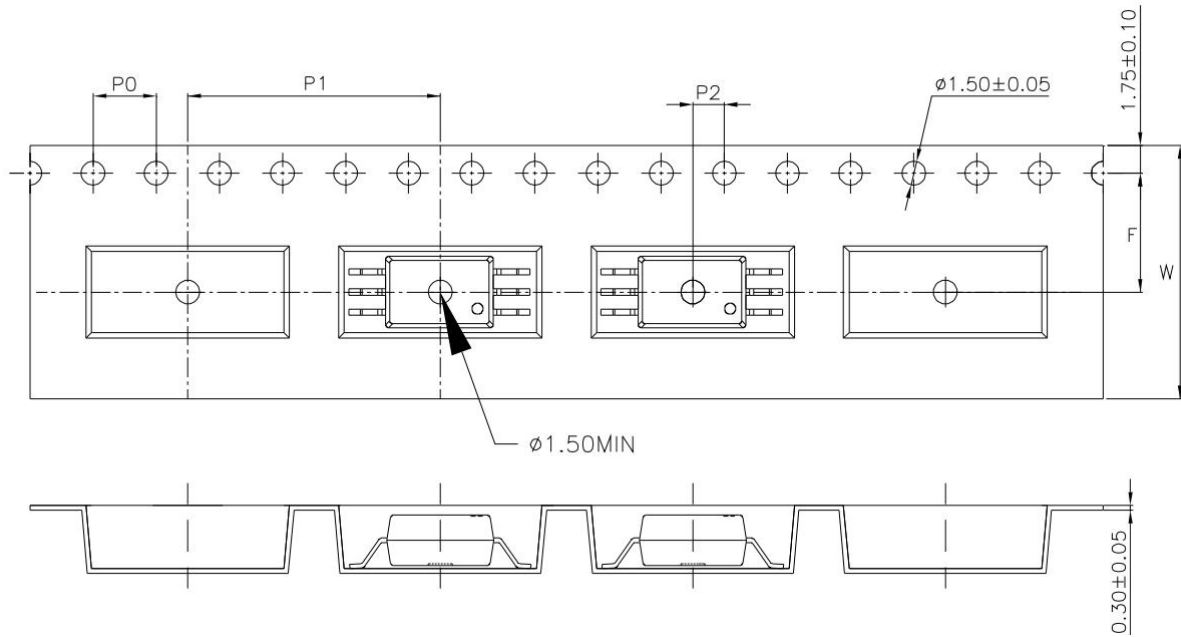

(2)OR-314W-TA1

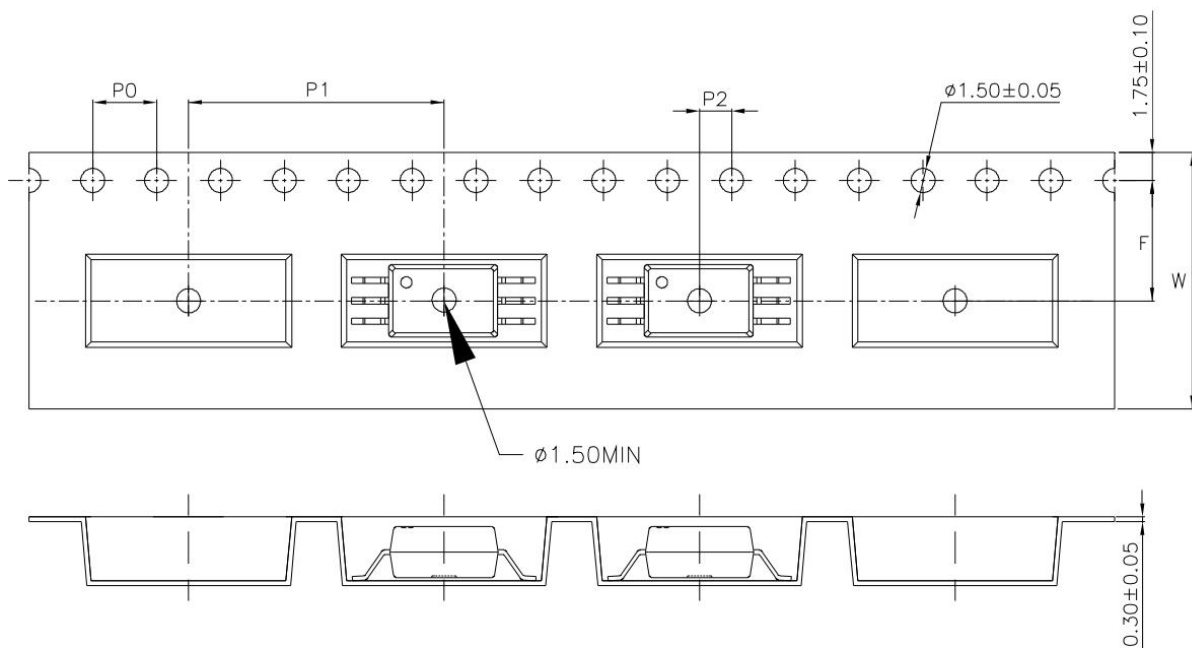

(1)OR-314W1-TA

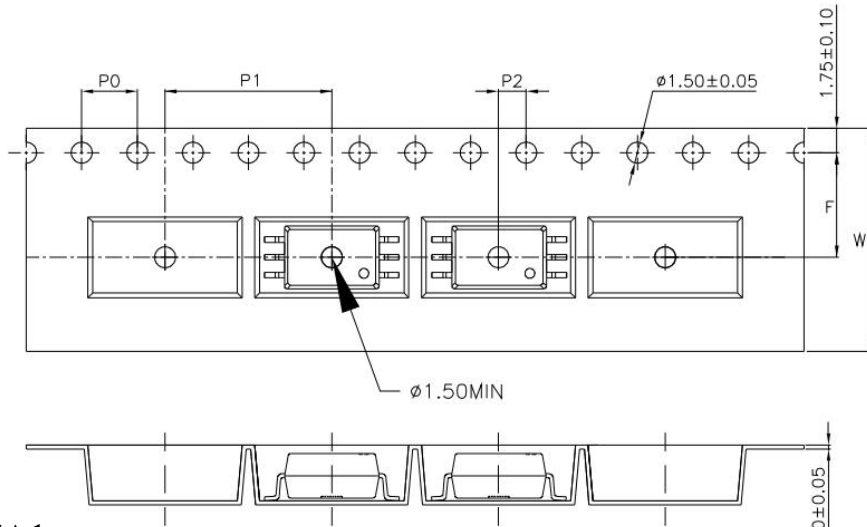

(2)OR-314W1-TA1

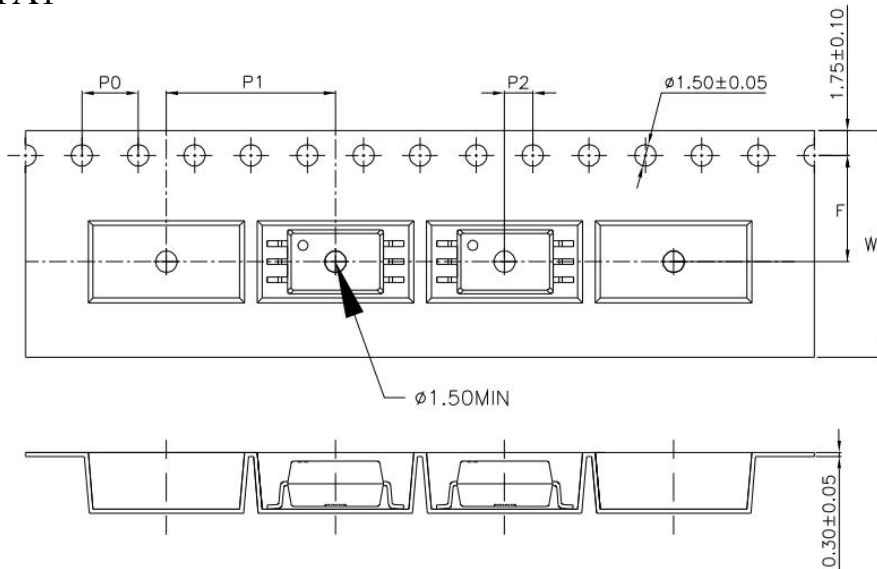

Type	symbol	Dimension in mm (inch) For W type	Dimension in mm (inch) For W1 type
bandwidth	W	16 ± 0.3 (0.63)	16 ± 0.3 (0.63)
pitch	P0	4 ± 0.1 (0.16)	4 ± 0.1 (0.16)
pitch	F	7.5 ± 0.1 (0.3)	7.5 ± 0.1 (0.3)
	P2	2 ± 0.1 (0.079)	2 ± 0.1 (0.079)
interval	P1	16 ± 0.1 (0.63)	12 ± 0.1 (0.47)

Encapsulation type	TA/TA1
amount (pcs)	1000

12. Package Dimension

(1) package dimension

Packing Information	
Packing type	Reel type
Tape Width	16mm
Qty per Reel	1,000pcs
Small box (inner) Dimension	345*345*58.5mm
Large box (Outer) Dimension	620x360x360mm
Max qty per small box	2,000pcs
Max qty per large box	20,000pcs

(2)Packing Label Sample



The label sample includes the following elements:

- Logos:** ORIENT (ShenZhen Orient Components Co.,LTD), VDE, UL, and RoHS REACH.
- Material Code:** 120PCXXXXXX
- P/N:** OR-XXXXXX
- Lot No.:** XXXXXX-XXXXX-TX-X
- D/C:** XXXX
- Qty:** XXXX PCS
- Internal/External Box Codes:** 内箱码 (Inner Box Code) and 外箱码 (Outer Box Code).
- Serial Number:** "XXXXXXXXXXXXXXXX" (一体机序列码) - Integrated Machine Serial Number.
- Origin:** Made in China.

Note:

1. Material Code :Product ID.
2. P/N :Contents with "Order Information" in the specification.
3. Lot No. :Product data.
4. D/C :Product weeks.
5. Quantity :Packaging quantity.

13. Temperature Profile Of Soldering

(1).IR Reflow soldering (JEDEC-STD-020C compliant)

One time soldering reflow is recommended within the condition of temperature and time profile shown below. Do not solder more than three times.

Profile item	Conditions
Preheat - Temperature Min (T Smin) - Temperature Max (T Smax) - Time (min to max) (ts)	150°C 200°C 90±30 sec
Soldering zone - Temperature (TL) - Time (t L)	217°C 60 sec
Peak Temperature	260°C
Peak Temperature time	20 sec
Ramp-up rate	3°C / sec max.
Ramp-down rate from peak temperature	3~6°C / sec
Reflow times	≤3

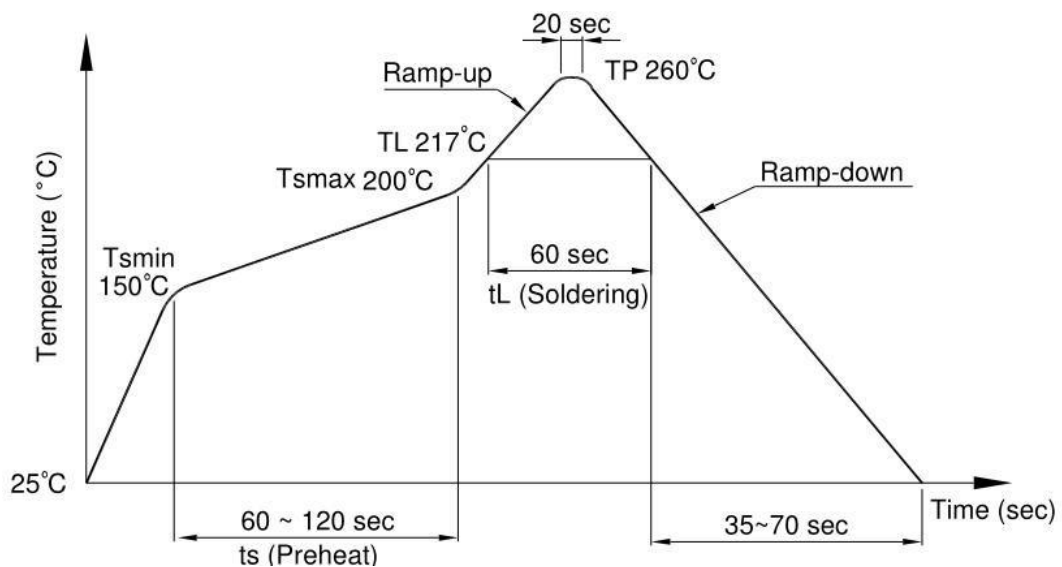

(3) .Wave soldering (JEDEC22A111 compliant)

One time soldering is recommended within the condition of temperature.

Temperature	260+0/-5°C
Time	10 sec
Preheat temperature	5 to 140°C
Preheat time	30 to 80 sec

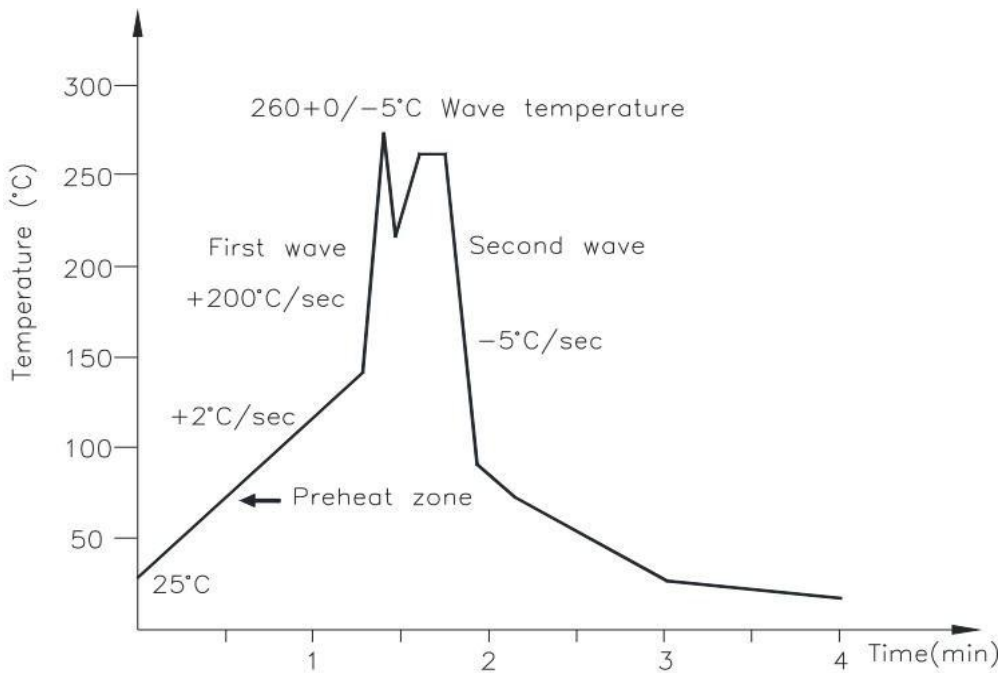

(3).Hand soldering by soldering iron

Allow single lead soldering in every single process. One time soldering is recommended.

Temperature	380+0/-5°C
Time	3 sec max

14. CHARACTERISTICS CURVES (TYPICAL PERFORMANCE)

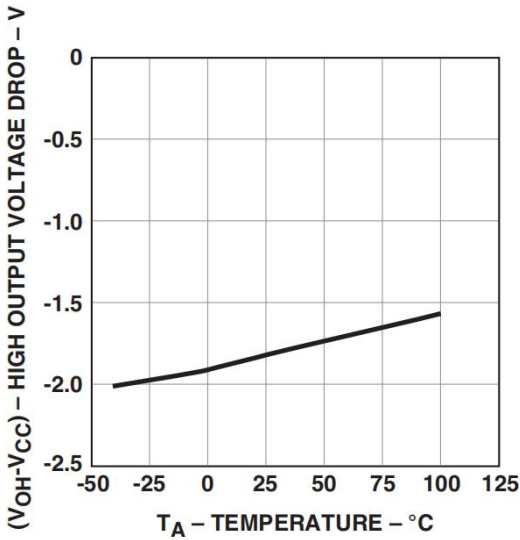

Figure 1. V_{OH} vs. Temperature.

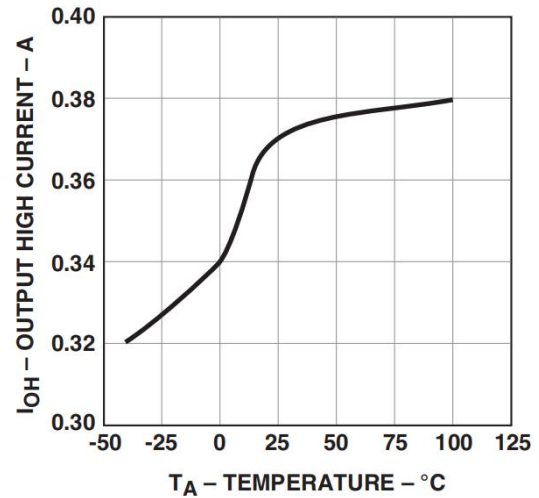

Figure 2. I_{OH} vs. Temperature.

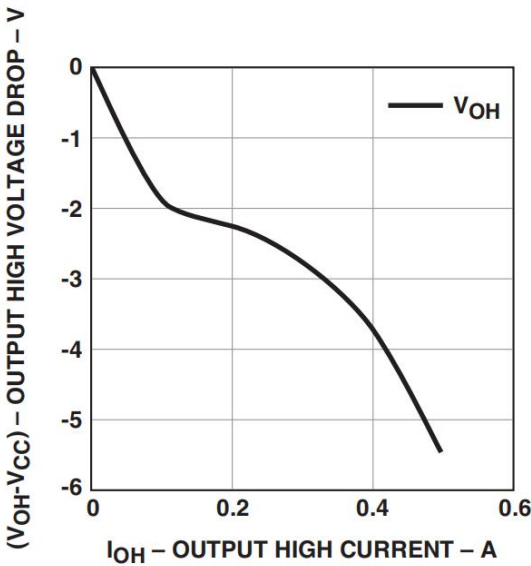

Figure 3. V_{OH} vs. I_{OH} .

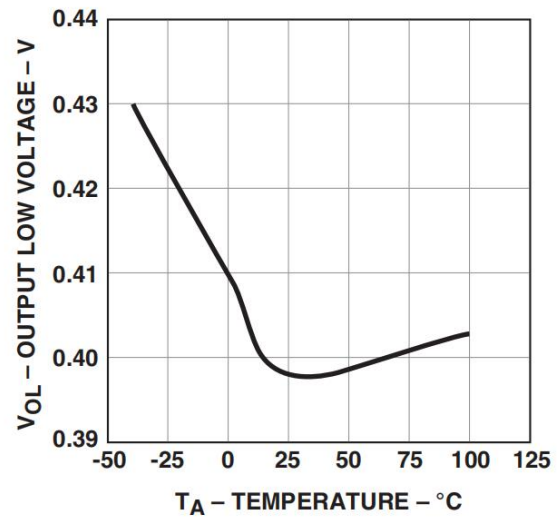

Figure 4. V_{OL} vs. Temperature.

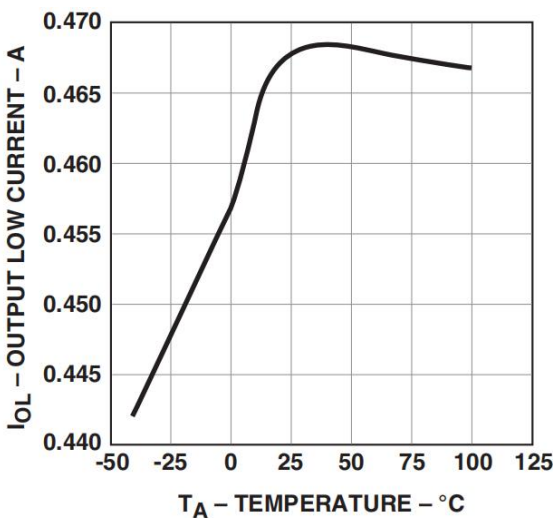

Figure 5. I_{OL} vs. Temperature.

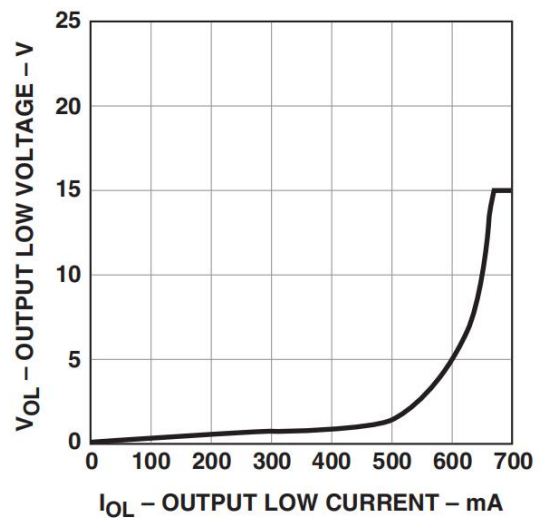

Figure 6. V_{OL} vs. I_{OL} .

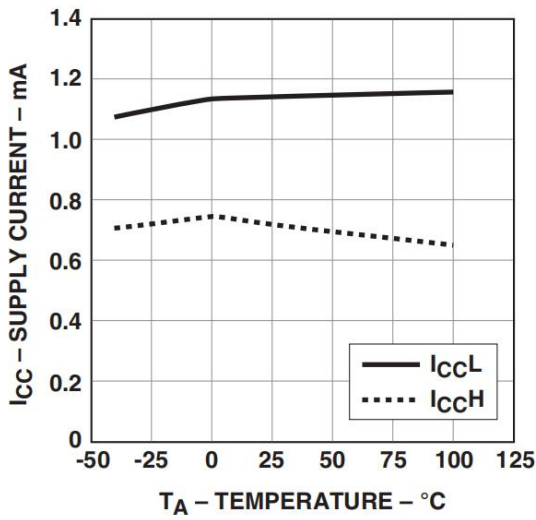

Figure 7. I_{CC} vs. Temperature.

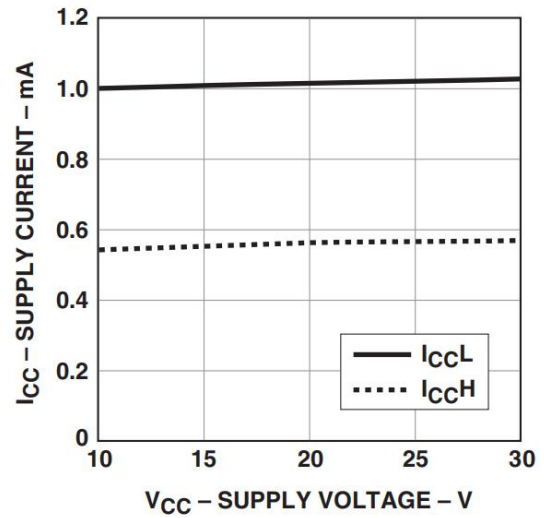

Figure 8. I_{CC} vs. V_{CC}.

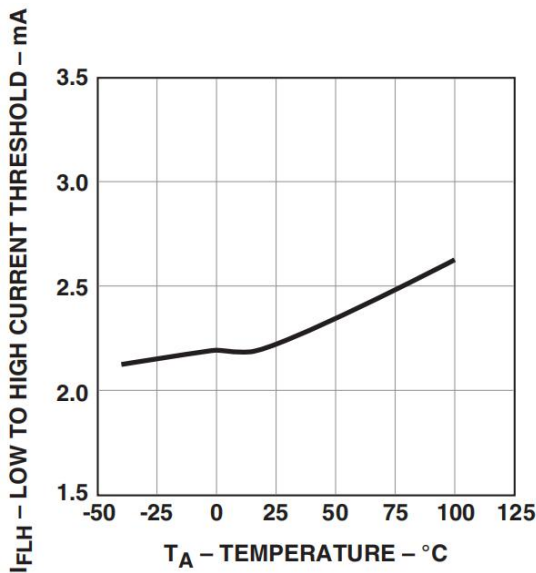

Figure 9. I_{FLH} vs. Temperature.

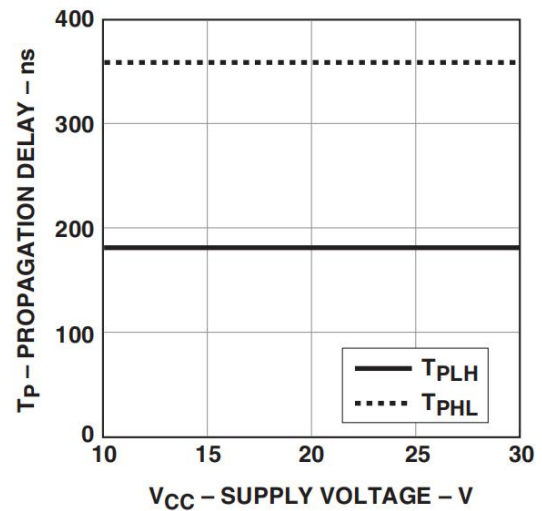

Figure 10. Propagation Delay vs. V_{CC}.

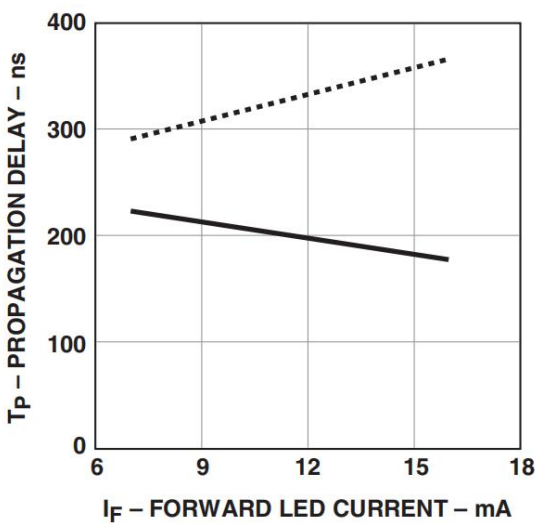

Figure 11. Propagation Delay vs. I_F.

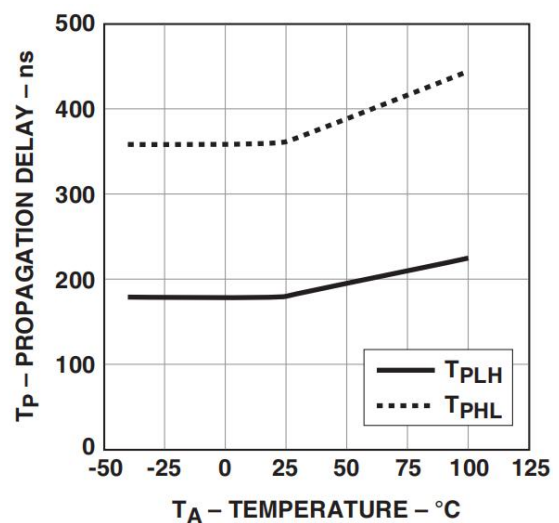

Figure 12. Propagation Delay vs. Temperature.

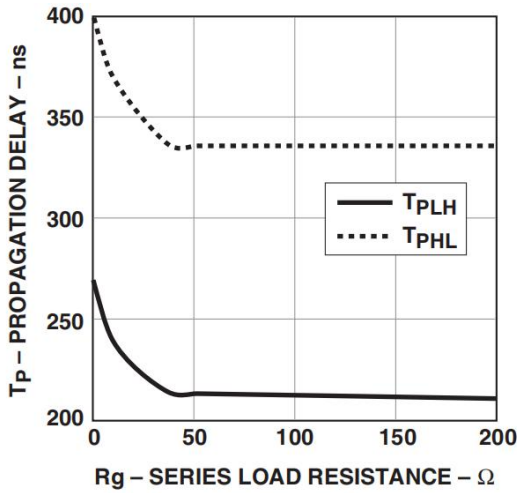

Figure 13. Propagation Delay vs. Rg.

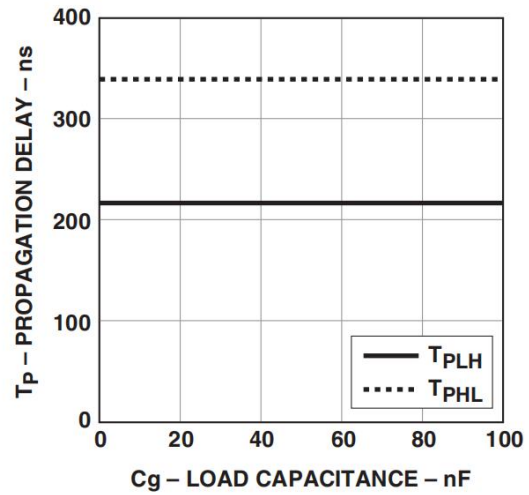

Figure 14. Propagation Delay vs. Cg.

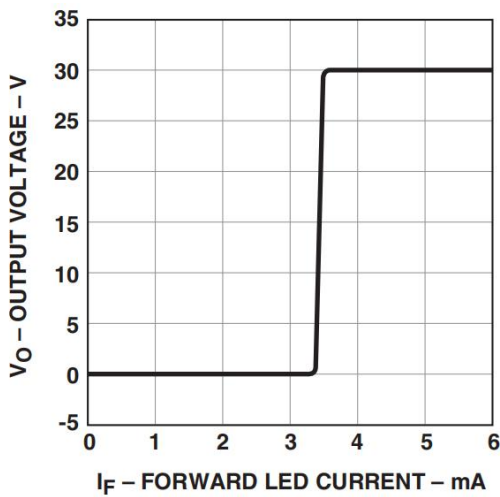

Figure 15. Transfer Characteristics.

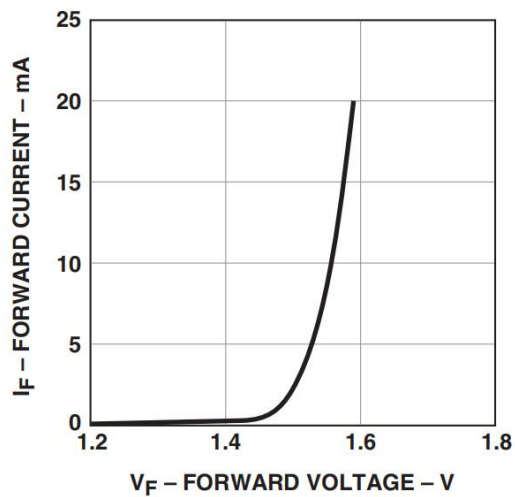

Figure 16. Input Current vs. Forward Voltage.

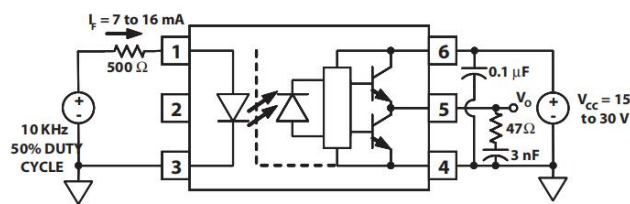

Figure 17. Propagation Delay Test Circuit and Waveforms.

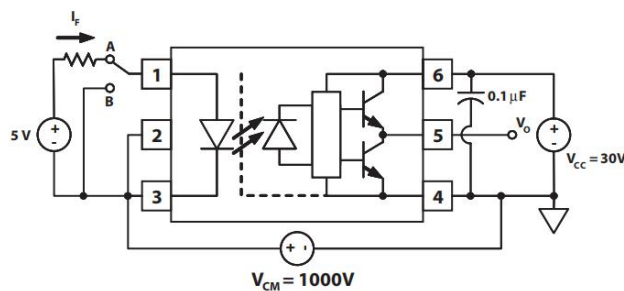
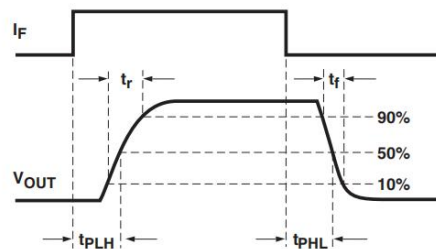

Figure 18. CMR Test Circuit and Waveforms.

