

»Features

- Excellent clamping capability
- Low leakage current
- Low capacitance
- High surge capability
- Glass passivated chip
- Epoxy resin package
- Will not fatigue
- RoHS Compliant
- Meets AEC-Q101
- Meets ISO7637-2、16750-2 surge specification
- ISO 7637-2 P5a:
 12V System (65-87V 0.5-4Ω 40-400ms)
 24V System (123-174V 1-8Ω 100-350ms)

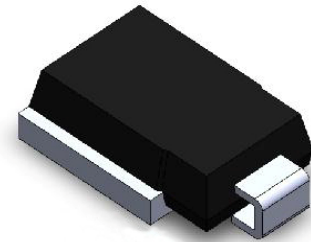

DO-218 (DO-218AB)

»Mechanical Characteristics

- Package: DO-218 plastic package.
- Lead Finish: Matte Tin
- Case Material: Epoxy Molding Compound.
- UL Flammability Classification Rating 94V-0
- Moisture Sensitivity: Level 1 per J-STD-020

»Applications

- Auto powers system
- Can-bus
- ABS powers
- Automotive instrument
- Car GPS

»Electrical Parameters

Parameter	Definition
C_J	Junction Capacitance - typical capacitance measured with 0V or V_R bias
I_{PP}	Peak Pulse Current - maximum rated peak impulse current
V_C	Clamping Voltage - Peak voltage measured across the suppressor at a specified I_{ppm} (peak impulse current)
V_{BR}	Breakdown Voltage - Maximum voltage that flows through the TVS at a specified test current (I_T)
I_R	Leakage Current - maximum peak off-state current measured at V_R
V_R	Peak Off-state Voltage - maximum voltage that can be applied while maintaining off state

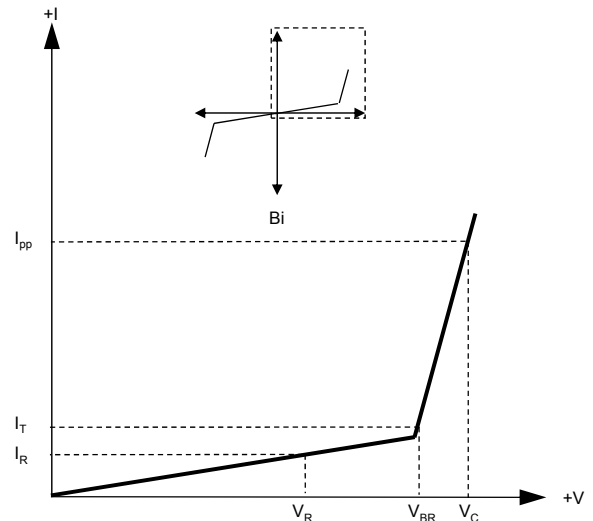
»Summary of Packing Options

Package	Packing Description	Packing Quantity	Industry Standard
DO-218	Tape/Reel, 13" reel	750	EIA-481-1
	Tape/Reel, 7" reel	150	EIA-481-1

»Absolute Maximum Ratings ($T_A=25^{\circ}\text{C}$ unless otherwise noted)

Parameter	Symbol	Value	Units	Remarks
Peak Pulse Power Dissipation	P_{PPM}	6600	W	(Note1)
Peak Pulse Power Dissipation	P_{PPM1}	5200	W	(Note2)
Steady State Power Dissipation	P_D	8	W	(Note3)
Peak Forward Surge Current	I_{FSM}	700	A	(Note4)
Maximum Instantaneous Forward Voltage at 100A	V_{FM}	3.5	V	
Typical Thermal Resistance Junction to Case	$R_{\theta JC}$	0.9	$^{\circ}\text{C}/\text{W}$	
Typical Thermal Resistance Junction to Ambient	$R_{\theta JA}$	11	$^{\circ}\text{C}/\text{W}$	
Operating Temperature Range	T_J	-55 to 175	$^{\circ}\text{C}$	
Storage Temperature Range	T_{STG}	-55 to 175	$^{\circ}\text{C}$	

Notes1: Non-repetitive current pulse , 10/1000us Waveform.

Notes2: Non-repetitive current pulse , 10/10000us Waveform.

Notes3: Infinite Heat Sink at $T_A=50^{\circ}\text{C}$.

Notes4: Measured on 8.3ms single half sine wave or equivalent square wave, duty cycle=4 per minute maximum.

»Electrical Characteristics ($T_A=25^{\circ}\text{C}$ unless otherwise noted)

Part Number	Reverse Stand-off Voltage V_R (V)	Breakdown Voltage V_{BR} @ I_T (V)		Test Current I_T (mA)	Maximum Clamping Voltage V_C @ I_{PP} (V)	Maximum Peak Pulse Current I_{PP} (A)	Maximum Reverse Leakage I_R @ V_R (μA)
		Min	Max				
SM8S10CA	10	11.1	12.3	5	17	388	15
SM8S11CA	11	12.2	13.5	5	18.2	363	10
SM8S12CA	12	13.3	14.7	5	19.9	332	10
SM8S13CA	13	14.4	15.9	5	21.5	307	10
SM8S14CA	14	15.6	17.2	5	23.2	284	10
SM8S15CA	15	16.7	18.5	5	24.4	270	10
SM8S16CA	16	17.8	19.7	5	26	254	10
SM8S17CA	17	18.9	20.9	5	27.6	239	10
SM8S18CA	18	20	22.1	5	29.2	226	10
SM8S20CA	20	22.2	24.5	5	32.4	204	10
SM8S22CA	22	24.4	26.9	5	35.5	186	10
SM8S24CA	24	26.7	29.5	5	38.9	170	10
SM8S26CA	26	28.9	31.9	5	42.1	157	10
SM8S28CA	28	31.1	34.4	5	45.4	145	10
SM8S30CA	30	33.3	36.8	5	48.4	136	10
SM8S33CA	33	36.7	40.6	5	53.3	124	10
SM8S36CA	36	40	44.2	5	58.1	114	10
SM8S40CA	40	44.4	49.1	5	64.5	102	10
SM8S43CA	43	47.8	52.8	5	69.4	95.1	10

»Rating And Characteristic Curves ($T_A=25^\circ\text{C}$ unless otherwise noted)

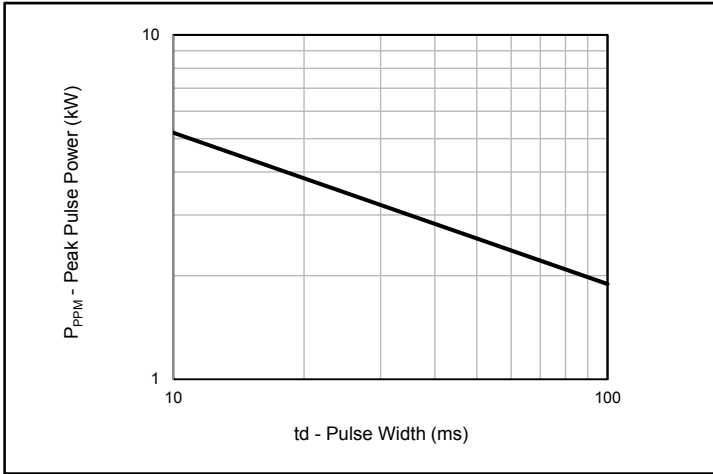

Fig.1 - Peak Pulse Power Rating

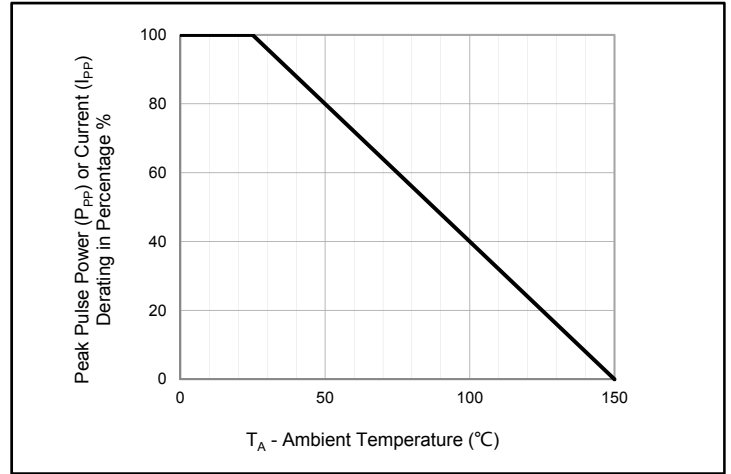

Fig.2 - Pulse Derating Curve

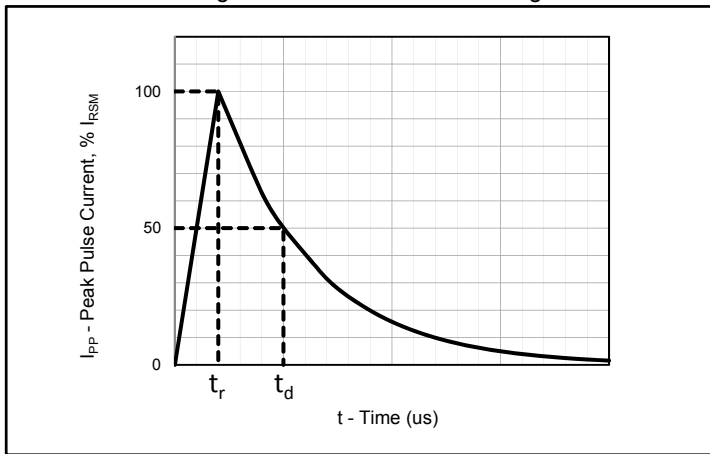

Fig.3 - Pulse Waveform

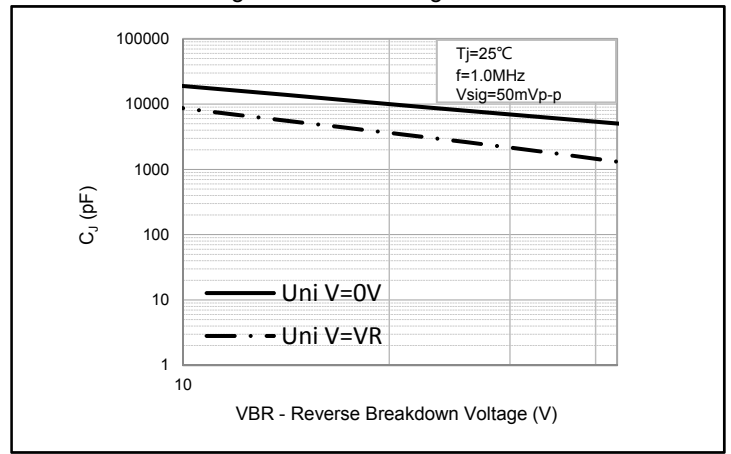

Fig.4 - Typical Junction Capacitance

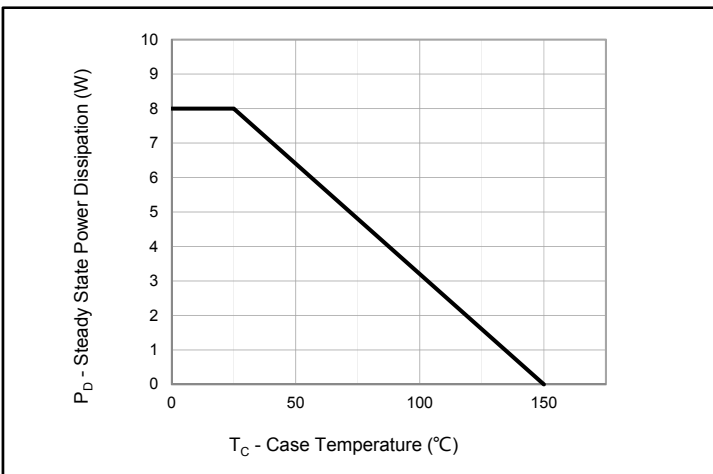

Fig.5 - Steady State Power Dissipation Derating Curve

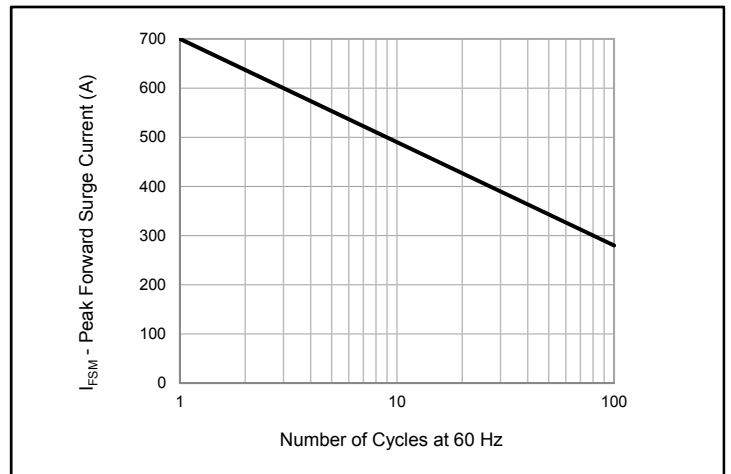
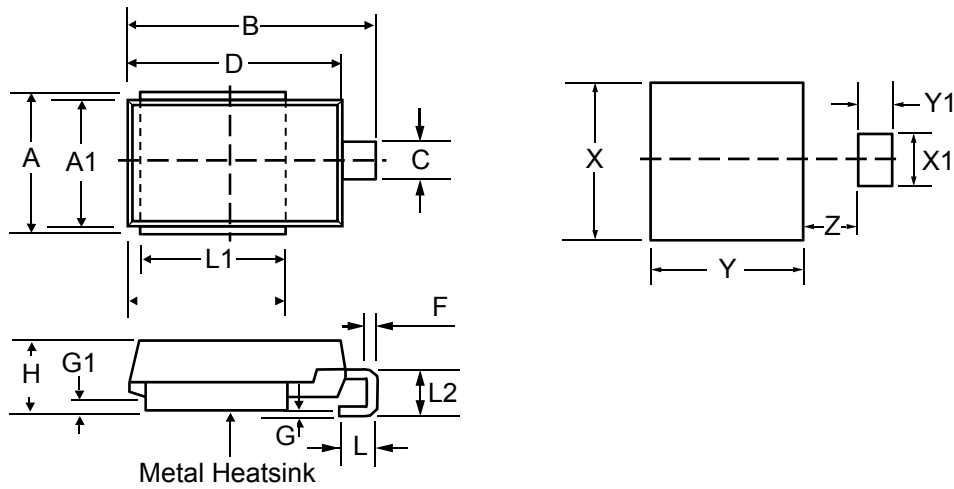

Fig.6 - Maximum Non-Repetitive Peak Forward Surge Current

»Package Dimensions



DO-218						
Dimension	Inches			Millimeters		
	MIN	NOM	MAX	MIN	NOM	MAX
A	0.374	0.394	0.413	9.5	10	10.5
A1	0.327	0.335	0.343	8.3	8.5	8.7
B	0.591	0.614	0.63	15	15.6	16
C	0.094	0.106	0.118	2.4	2.7	3
D	0.524	0.531	0.539	13.3	13.5	13.7
F	0.02	0.024	0.028	0.5	0.6	0.7
G	-		0.008	-		0.2
G1		0.02			0.5	
H	0.185	0.191	0.197	4.7	4.85	5
L	0.059	0.079	0.098	1.5	2	2.5
L1	0.343	0.354	0.366	8.7	9	9.3
L2	0.098	0.118	0.138	2.5	3	3.5
X		0.394			10	
Y		0.354			9	
Z		0.138			3.5	
X1		0.106			2.7	
Y1		0.079			2	

»Marking Code

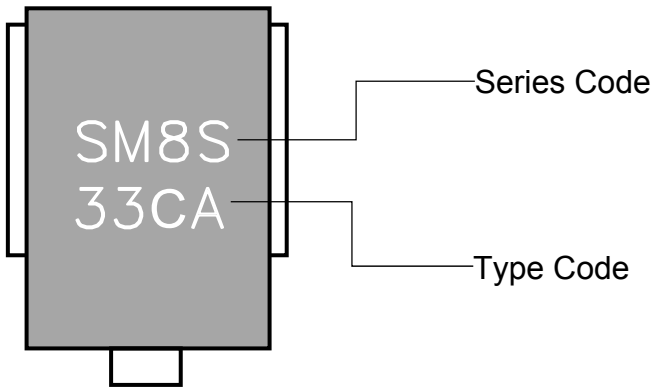

»Tape and Reel Specification

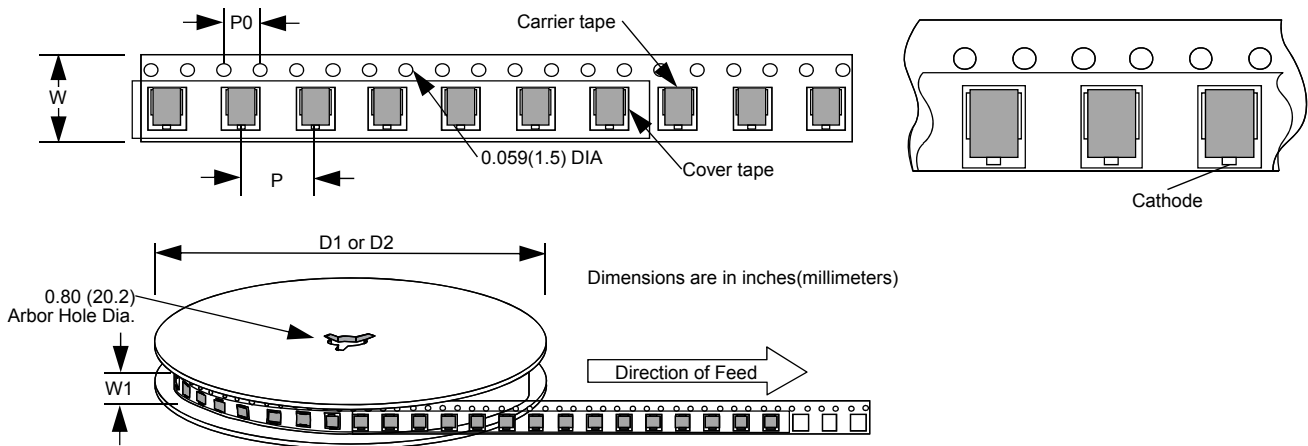

Dimension	Inches			Millimeters		
	MIN	NOM	MAX	MIN	NOM	MAX
P		0.63			16	
P0		0.157			4	
W		0.945			24	
W1		0.965			24.5	
D1		7			177.8	
D2		13			330.2	