



THINKING ELECTRONIC INDUSTRIAL CO., LTD.

HEAD OFFICE: 12F, No.93, Dashun 1st Rd., Zuoying Dist., Kaohsiung, Taiwan
TEL: 886-7-5577660 FAX: 886-7-5570560

MANUFACTURING SITE

- KAOHSIUNG FACTORY 1: No. 51, Kaifa Rd., N.E.P.Z, Kaohsiung City 81170, Taiwan
TEL: 886-7-9616668 FAX: 886-7-9616698
- KAOHSIUNG FACTORY 2: No. 2-2, Xinjian S. Rd., N.E.P.Z., Kaohsiung City 81170, Taiwan
TEL: 886-7-9630001 FAX: 886-7-3635113
- CHANGZHOU FACTORY: No.6 Longmen Rd., Wujin High & New-Tech Industrial
Development Zone, Changzhou, Jiangsu, China 213161
TEL: 86-519-86578999 FAX: 86-519-86558643
- DONG GUAN FACTORY: No.45, East Rd., Sha-Tao Dist., Chang-An Town,
Dongguan City, Guangdong, China 523863
TEL: 86-769-85542016 FAX: 86-769-85546890
- YICHANG FACTORY: No. 283 Xiaoting Avenue, Xiaoting Dist., Yichang
City 443007, Hubei, China
TEL: 86-717-6510010 FAX: 86-717-6511430



SPECIFICATION FOR APPROVAL

CUSTOMER _____

CERTIFIED
MODEL/TYPE

TVR07431

PART NO.

TVR07431KFARY-H (RoHS)

APPLICATION _____

CUSTOMER P/N _____

ISSUE DATE

Aug.21,2019

REV. NO. _____

REV. DATE _____

NET WEIGHT _____

FOR CUSTOMER APPROVAL	CHECKED BY
	Yuan Yuan
	APPROVED BY
	Huaifang Zhang





REVISED RECORD SHEET

REV. NO	REV. DATE	REVISED CONTENT



INDEX	Page
■ Part Number Code	1
■ Structure and Dimensions	2
■ Electrical Characteristics	2
■ Reliability	3 ~ 4
■ Soldering Recommendation	5
■ Power Derating Curve	6
■ RoHS Compliant Declaration	6
■ Warehouse Storage Conditions of Products	6
■ Taping and Dimensions	7
■ Packaging	8
■ Safety Approvals	9
■ Certificates	9
■ Max. Surge Current Derating Curves	10
■ Max. Leakage Current and Max. Clamping Voltage Curve	11

Part Number Code

Example :

TVR **07** **431** **K** **F** **AR** **Y** **-H**
 (1) (2) (3) (4) (5) (6) (7) (8)

No.	Item	Digit	Specification
(1)	Product Type	TVR	Thinking varistor TVR type
(2)	Body Size	07	φ 07 mm
(3)	Varistor Voltage	431	$43 \times 10^1 \text{ V} = 430\text{V} (V_{1\text{mA}})$
(4)	Tolerance of $V_{1\text{mA}}$	K	±10%
(5)	Appearance	F	Y Kink Lead, Epoxy Coating
(6)	Packaging	A	Repositioning tapping(hole pitch: 12.7mm)
		R	reel
(7)	Optional Suffix	Y	RoHS compliance
(8)	Customer code	-H	Design Location Region

Structure and Dimensions

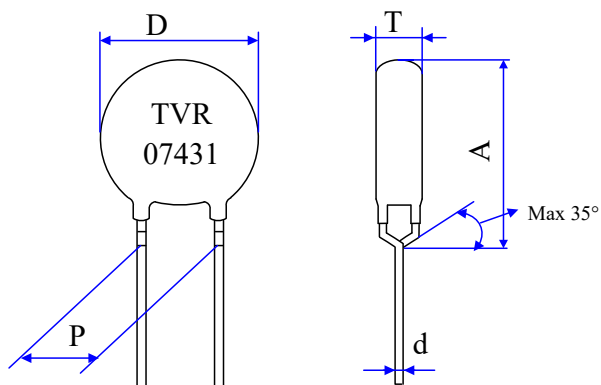

(unit : mm)

Body Size	D	P	d	A max.	T
φ 07	6.5~9.0	5.0±0.5	0.6±0.02	11.5	3.0~5.1

***Coating material rating:UL 94 V-0**

Electrical Characteristics (Ambient $T_a=25\text{ }^\circ\text{C}$)

Part No.	Varistor Voltage (@ 1mA DC)	Max. Continuous Voltage		Max. Clamping Voltage (8/20μS)		Max. Surge Current (8/20μS)	Max. Energy (10/1000μS)
	V_{1mA} (V)	$V_{AC(rms)}$ (V)	V_{DC} (V)	V_p (V)	I_p (A)	I (A)	W (J)
TVR07431KFARY-H	430 ± 10%	275	350	710	10	1200	28

Part No.	Rated Power	Impulse Response Time	Max. Leakage Current at 75% V_{1mA}	Operating Temperature Range	Storage temperature Range
	P (W)	nSec	$I_L(\mu A)$	($^\circ\text{C}$)	($^\circ\text{C}$)
TVR07431KFARY-H	0.25	<25	20	-40 ~ +105	-40 ~ +125

Reliability

Item	Standard	Test conditions / Methods	Specifications															
Tensile Strength of Terminals	IEC60068-2-21	Gradually applying the force specified and keeping the unit fixed for 10±1 sec. <table style="margin-left: auto; margin-right: auto;"> <tr> <td style="text-align: center;">Terminal diameter (mm)</td> <td style="text-align: center;">Force (Kg)</td> </tr> <tr> <td style="text-align: center;">0.5<d≤0.8</td> <td style="text-align: center;">1.0</td> </tr> <tr> <td style="text-align: center;">0.8<d≤1.25</td> <td style="text-align: center;">2.0</td> </tr> <tr> <td style="text-align: center;">1.25<d</td> <td style="text-align: center;">4.0</td> </tr> </table>	Terminal diameter (mm)	Force (Kg)	0.5<d≤0.8	1.0	0.8<d≤1.25	2.0	1.25<d	4.0	No visible damage $\Delta V/V_{1mA}$ ≤5%							
Terminal diameter (mm)	Force (Kg)																	
0.5<d≤0.8	1.0																	
0.8<d≤1.25	2.0																	
1.25<d	4.0																	
Bending Strength of Terminals	IEC60068-2-21	Hold specimen and apply the force specified below to each lead. Bend the specimen to 90°, then return to the original position. Repeat the procedure in the opposite direction. <table style="margin-left: auto; margin-right: auto;"> <tr> <td style="text-align: center;">Terminal diameter (mm)</td> <td style="text-align: center;">Force (Kg)</td> </tr> <tr> <td style="text-align: center;">0.5<d≤0.8</td> <td style="text-align: center;">0.5</td> </tr> <tr> <td style="text-align: center;">0.8<d≤1.25</td> <td style="text-align: center;">1.0</td> </tr> <tr> <td style="text-align: center;">1.25<d</td> <td style="text-align: center;">2.0</td> </tr> </table>	Terminal diameter (mm)	Force (Kg)	0.5<d≤0.8	0.5	0.8<d≤1.25	1.0	1.25<d	2.0	No visible damage $\Delta V/V_{1mA}$ ≤5%							
Terminal diameter (mm)	Force (Kg)																	
0.5<d≤0.8	0.5																	
0.8<d≤1.25	1.0																	
1.25<d	2.0																	
Vibration	IEC 60068-2-6	Frequency range:10~55Hz Amplitude:0.75mm or 98m/S ² Direction:3 mutually perpendicular directions,2hrs each.	$\Delta V/V_{1mA}$ ≤5% No visible damage															
Solderability	IEC60068-2-20	245 ± 3 °C , 3 ± 0.3 sec	At least 95% of terminal electrode is covered by new solder															
Resistance to Soldering Heat	IEC60068-2-20	260 ± 3 °C , 10 ± 1 sec	No visible damage $\Delta V/V_{1mA}$ ≤5%															
High Temperature Storage	IEC60068-2-2	125 ± 5 °C , 1000 ± 24 hrs	No visible damage $\Delta V/V_{1mA}$ ≤5%															
Damp Heat, Steady State	IEC 60068-2-78	The test is divided into two groups . a.40 ± 2°C , 90 ~ 95 % RH , 1344 hrs b.40 ± 2°C , 90 ~ 95 % RH , at 10%V _{DC} , 1344 hrs	No visible damage $\Delta V/V_{1mA}$ ≤10% Insulation Resistance ≥ 100MΩ															
Rapid Change of Temperature	IEC60068-2-14	The conditions shown below shall be repeated 5 cycles <table border="1" style="margin-left: auto; margin-right: auto;"> <thead> <tr> <th>Step</th> <th>Temperature (°C)</th> <th>Period (minutes)</th> </tr> </thead> <tbody> <tr> <td style="text-align: center;">1</td> <td style="text-align: center;">-40 ± 3</td> <td style="text-align: center;">30 ± 3</td> </tr> <tr> <td style="text-align: center;">2</td> <td style="text-align: center;">Room temperature</td> <td style="text-align: center;">5 ± 3</td> </tr> <tr> <td style="text-align: center;">3</td> <td style="text-align: center;">105 ± 2</td> <td style="text-align: center;">30 ± 3</td> </tr> <tr> <td style="text-align: center;">4</td> <td style="text-align: center;">Room temperature</td> <td style="text-align: center;">5 ± 3</td> </tr> </tbody> </table>	Step	Temperature (°C)	Period (minutes)	1	-40 ± 3	30 ± 3	2	Room temperature	5 ± 3	3	105 ± 2	30 ± 3	4	Room temperature	5 ± 3	No visible damage $\Delta V/V_{1mA}$ ≤5%
Step	Temperature (°C)	Period (minutes)																
1	-40 ± 3	30 ± 3																
2	Room temperature	5 ± 3																
3	105 ± 2	30 ± 3																
4	Room temperature	5 ± 3																
High Temp. Load	MIL-STD-202 Method 108	105 ± 2 °C , 1000 ± 24 hrs, at V _{DC} or V _{rms} (Max. Operating Voltage)	$\Delta V/V_{1mA}$ ≤10% No visible damage															



Item	Standard	Test conditions / Methods	Specifications
8/20 μ S Surge Life	IEC 61051-1 4.6	10 pulses(8/20 μ S) , unipolar, interval 30 secs,amplitude corr. to max. Surge current derating curves for 20 μ S.	$ \Delta V/V_{1mA} \leq 10\%$ No visible damage
10/1000 μ S Surge Life	IEC 61051-1 4.6	10/1000 μ S waveform, 10 surge currents,unipolar,interval 2mins, amplitude corr. to max. surge current derating curves for 1000 μ S	$ \Delta V/V_{1mA} \leq 10\%$ No visible damage
Varistor Voltage Temp. Coefficient	Specification Standard	$\frac{V_{1mA} \text{ at } 105^{\circ}\text{C} - V_{1mA} \text{ at } 25^{\circ}\text{C}}{V_{1mA} \text{ at } 25^{\circ}\text{C}} \times \frac{1}{80} \times 100 (\% / ^{\circ}\text{C})$ $\frac{V_{1mA} \text{ at } -40^{\circ}\text{C} - V_{1mA} \text{ at } 25^{\circ}\text{C}}{V_{1mA} \text{ at } 25^{\circ}\text{C}} \times \frac{1}{65} \times 100 (\% / ^{\circ}\text{C})$	$-0.05 \leq TC \leq 0.05 (\% / ^{\circ}\text{C})$
Voltage Proof	IEC 61051-1 4.9	Metal balls method, 2500 Vac 1 min	No visible damage

Soldering Recommendation

Wave Soldering Profile

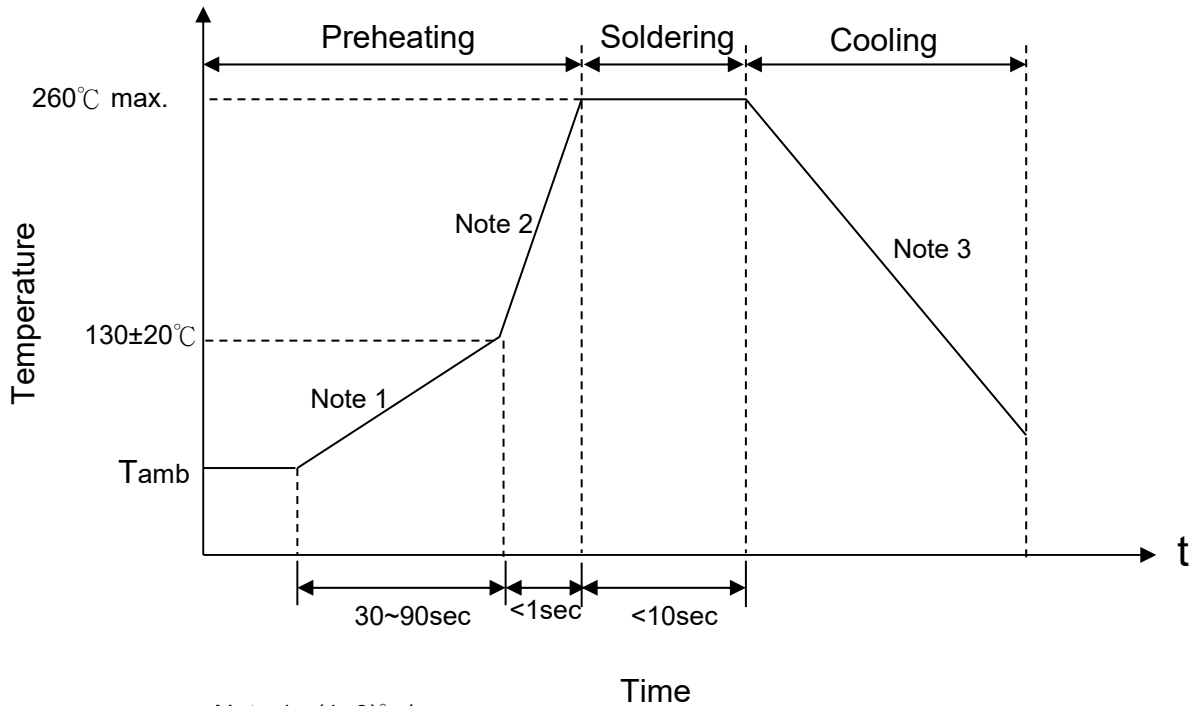

- Note 1 : $(1\sim 3)^\circ\text{C/sec}$
 Note 2 : Approx. 200°C/sec
 Note 3 : 5°C/sec Max

Recommended Reworking Conditions with Soldering Iron

Item	Conditions
Temperature of Soldering Iron-tip	360°C (max.)
Soldering Time	3 sec (max.)
Distance from Varistor	2 mm (min.)

Power Derating Curve

When operating temperature exceeds 105°C, the power, the Max.continuous operation Voltage,the Max.Surge Current and the Max.Energy should be derated as below figure, the derated coefficient is -5%.

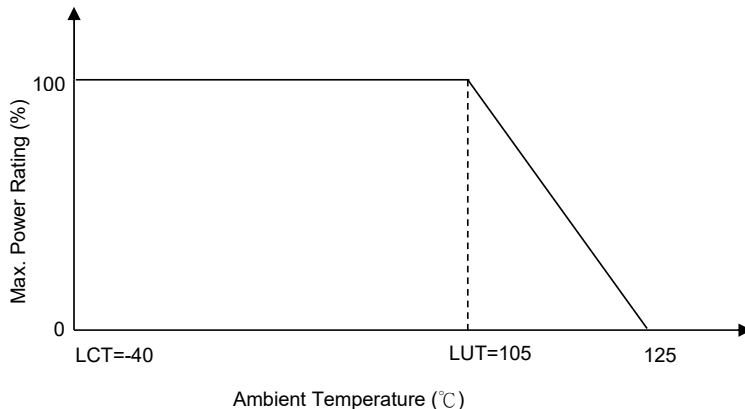

RoHS Compliant Declaration

We hereby declare that the components delivered to your company are compliant with RoHS directive 2015/863/EU.

Warehouse Storage Conditions of Products

(I) Storage Conditions :

- 1.Storage Temperature : -10°C~+40°C
- 2.Relative Humidity : $\leq 75\%RH$
- 3.Keep away from corrosive atmosphere and sunlight.

(II) Period of Storage : 1 year

Taping and Dimensions

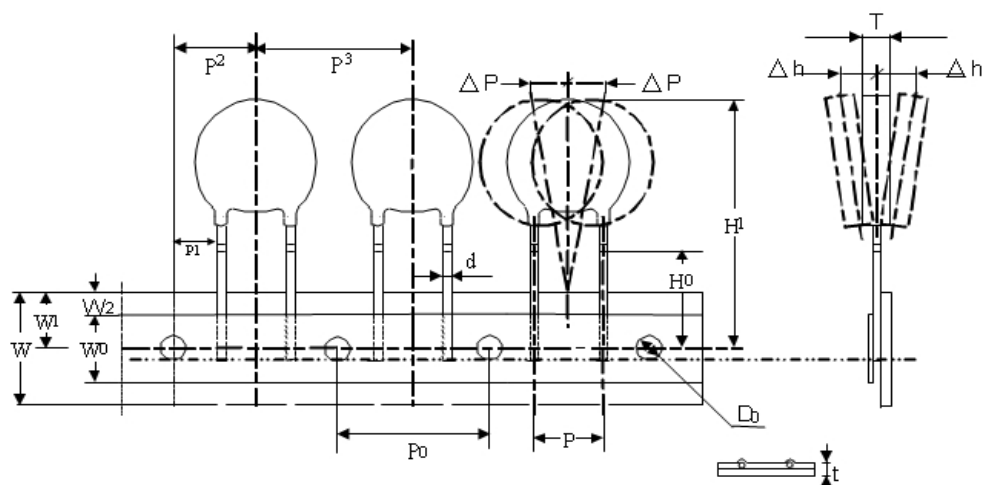

(Unit : mm)

ITEM.	P ₀	P	P ₁	P ₂	P ₃	H ₀	H ₁ Max	W ₀	W ₁	W ₂ Max	W	Δp Max	Δh Max	D ₀	t
Nor.	12.7	5.0	3.55	6.35	12.7	16	30	12	9	3	18	1.0	2.0	4	0.6
ToL.	±0.3	±1	±1	±13	±1	±0.5	---	±1	+0.75/ -0.5	---	±1	---	---	±0.2	±0.2

Packaging

(1) SPQ: 1000 Pcs/ Reel

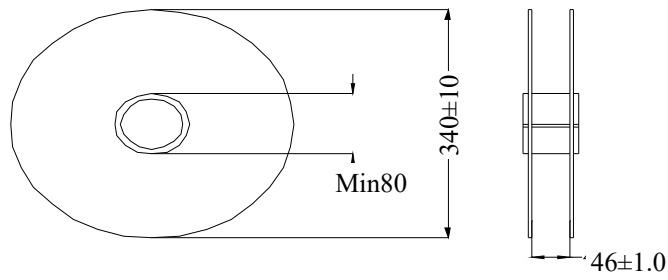

(2) Outer Box: 5 Reels/ Carton

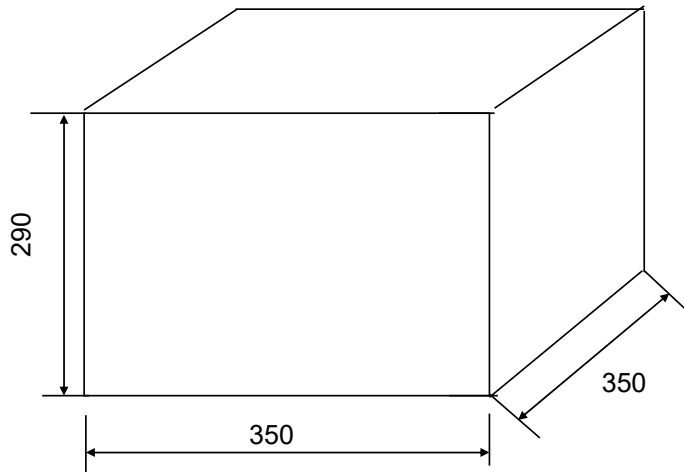

(Unit:mm)

Safety Approvals (Certified Model/Type:TVR07431)

* UL 1449 4th / cUL recognized (File # E314979)



* TUV recognized (File J50411784)



* CQC GB/T10193-1997 ` GB/T10194-1997 recognized
(File # CQC18001199806/ CQC18001199789)

Certificates

- (1) IATF 16949 certificate
- (2) ISO 9001 certificate

Test Report

- (1) RoHS test report



Max. Surge Current Derating Curves

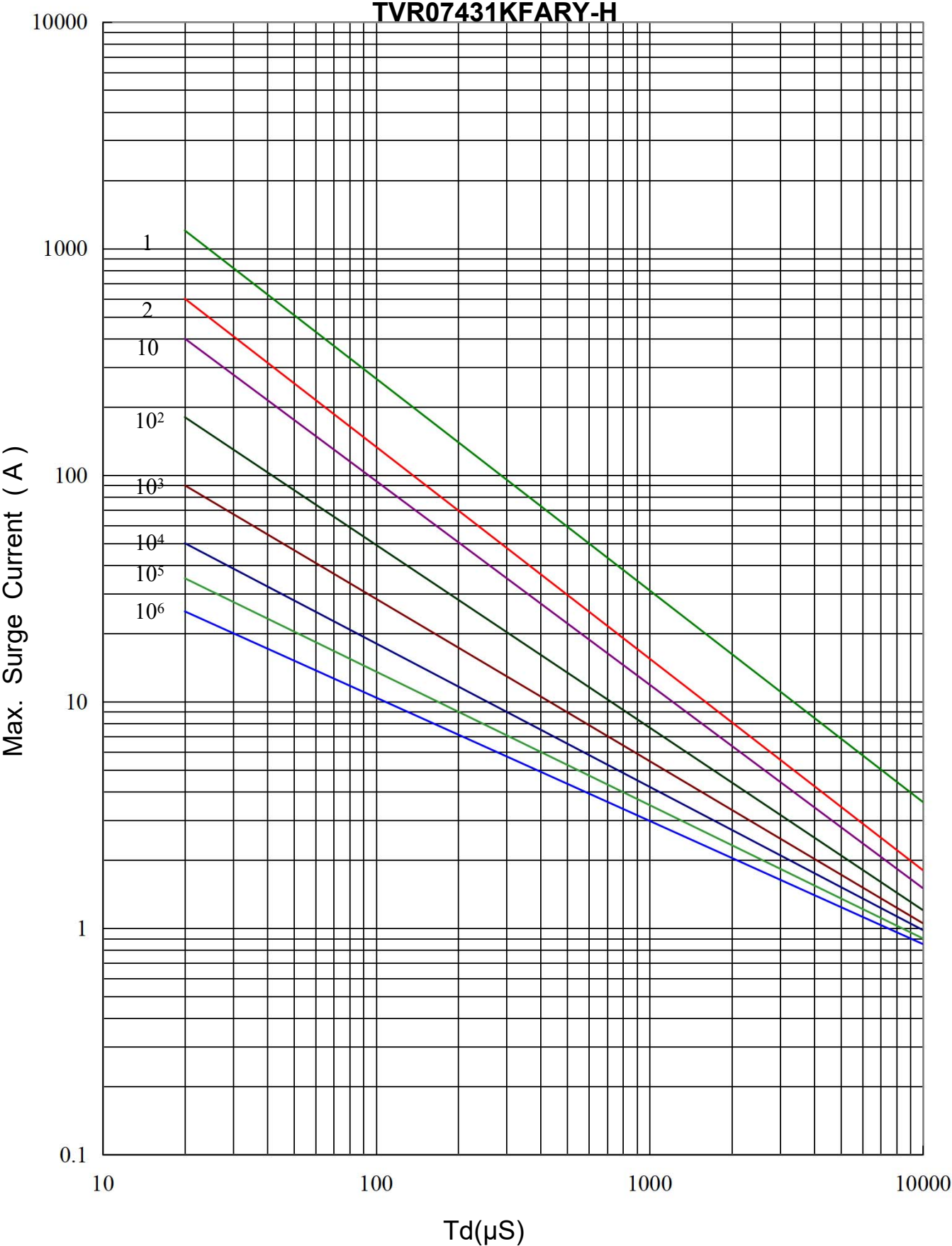

Max. Leakage Current and Max. Clamping Voltage Curve

